

DFO - Library / MPO - Bibliothèque



12038953

# Guide to the Freshwater Aquatic Microdrile Oligochaetes of North America

R.O. Brinkhurst



QL  
626  
C 314  
#84  
C-2



Fisheries and Oceans / Pêches et Océans

Canadian Special Publication of Fisheries and Aquatic Sciences 84

QL  
626  
C314  
#84  
e2

# Guide to the Freshwater Aquatic Microdrile Oligochaetes of North America

**R. O. Brinkhurst**

*Department of Fisheries and Oceans  
Institute of Ocean Sciences  
9860 West Saanich Road  
Sidney, British Columbia V8L 4B2*

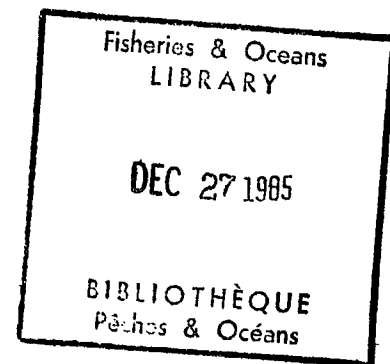

DEPARTMENT OF FISHERIES AND OCEANS  
Ottawa 1986





Published by

Fisheries  
and Oceans

Scientific Information  
and Publications Branch

Publié par

Pêches  
et Océans

Direction de l'information  
et des publications scientifiques

Ottawa K1A 0E6

©Minister of Supply and Services Canada 1986

Available from authorized bookstore agents, other bookstores  
or you may send your prepaid order to the  
Canadian Government Publishing Centre  
Supply and Services Canada, Ottawa, Ont. K1A 0S9.

Make cheques or money orders payable in Canadian funds  
to the Receiver General for Canada.

A deposit copy of this publication is also available  
for reference in public libraries across Canada.

Canada: \$14.95	Cat. No. Fs 41-31/84E
Other Countries: \$17.95	ISBN 0-660-11924-2
	ISSN 0706-6481

Price subject to change without notice

Director and Editor-in-Chief: J. Watson, Ph.D.  
Assistant Editor: D. G. Cook, Ph.D.  
Publication Production Coordinator: G. J. Neville  
Printer: Buchanan Printers, Winnipeg, Manitoba  
Cover Design: André, Gordon and Laundreth Inc., Ottawa, Ontario

*This publication has been peer reviewed.*

Correct citation for this publication:

BRINKHURST, R. O. 1986. Guide to the freshwater aquatic microdrile oligochaetes of North America. Can. Spec. Publ. Fish. Aquat. Sci. 84: 259 p.

## CONTENTS

ABSTRACT/RÉSUMÉ .....	iv
FOREWORD .....	v
ACKNOWLEDGEMENTS .....	vi
INTRODUCTION .....	1
Preparation of Material .....	2
Examination of Whole Mounts .....	3
Chaetae .....	4
Reproductive Organs .....	7
Evolution and Classification .....	12
Checklist .....	19
BIOLOGY .....	23
USE OF THE KEYS .....	26
KEY TO FAMILIES .....	28
HAPLOTAXIDAE .....	31
OPISTOCYSTIDAE .....	35
NAIDIDAE .....	39
TUBIFICIDAE .....	109
LUMBRICULIDAE .....	209
REFERENCES .....	249
NEW TAXONOMIC DECISIONS .....	253
INDEX .....	255



## ABSTRACT

BRINKHURST, R. O. 1986. Guide to the freshwater aquatic microdrile oligochaetes of North America. Can. Spec. Publ. Fish. Aquat. Sci. 84: 259 p.

The five families of freshwater aquatic microdrile oligochaetes reviewed contain some 150 species. Keys and brief descriptions together with illustrations are provided for all species known from Alaska and Canada to the southern border of the United States. *Dero* (*Aulophorus*) *lodei* nom. nov. is created for *D. intermedius* Loden & Harman (= *D. (A.) pectinatus* Stephenson). *Varichaetadrilus psammophilus* (Loden, 1977) is a n. comb. for *Limnodrilus psammophilus* Loden. *Tasserkidrilus* is used in new combinations for species of *Tubifex*. The evolution and classification of the Oligochaeta are reviewed.

## RÉSUMÉ

BRINKHURST, R. O. 1986. Guide to the freshwater aquatic microdrile oligochaetes of North America. Can. Spec. Publ. Fish. Aquat. Sci. 84: 259 p.

Les cinq familles d'oligochètes microdriles dulçaquicoles faisant l'objet de la présente révision regroupent quelque 150 espèces. On fournit des clés et de brèves descriptions accompagnées d'illustrations de toutes les espèces signalées en Alaska et au Canada jusqu'à la frontière sud des États-Unis. Un nom nouveau, *Dero* (*Aulophorus*) *lodei* nom. nov., est créé pour *D. intermedius* Loden & Harman (= *D. (A.) pectinatus* Stephenson). *Varichaetadrilus psammophilus* (Loden, 1977) est une n. comb. pour *Limnodrilus psammophilus* Loden tandis que *Tasserkidrilus* est utilisé comme n. comb. pour les espèces de *Tubifex*. On examine aussi l'évolution et la classification des Oligochètes.

## FOREWORD

In freshwater environments, oligochaetes represent one of the most abundant and diverse groups of the benthic infauna. Composition and relative abundance of oligochaetes will vary with water quality conditions, habitat, season, and other environmental parameters. Assessment of environmental quality can be made with a knowledge of the oligochaete faunal structure and then monitoring changes in structure over time.

Some species such as *Limnodrilus hoffmeisteri* and *Bothrioneurum vej dovskyanum* are ubiquitous in distribution and are tolerant of a wide range of environmental conditions. Other species such as *Stylo drilus heringianus* and *Tubifex kessleri* are more restricted in their distribution and are more sensitive to wide environmental fluctuation. Oligochaetes represent a variety of functional guilds comprising detritophiles, periphytophiles, benthophiles, etc. Some worms, such as *Chaetogaster*, are carnivorous. Quantitative collections of the benthos including oligochaetes can be used to evaluate the biological integrity of the aquatic system under study.

Knowledge of the composition of the oligochaete fauna is important to taxonomists, aquatic ecologists, and environmental biologists. Records of species lists and estimated densities provide the basis for the study of environmental relationships, faunal distributions and biogeography. Because of the complexity and diversity of oligochaetes in freshwater systems, faunal investigations and environmental assessments that exclude oligochaete records may be wholly deficient.

This key has been designed to assist both the novice and experienced oligochaetologist in quickly ascertaining the proper identity of each specimen. This key will be useful to biologists who perform ecological surveys of the benthos in streams, lakes, and river systems. However, as in all keys, obtaining good results depends on knowing the proper mode of preparation and examination of material and an understanding of the salient anatomical features used in the key. No amount of time spent sifting through the key in growing frustration will ever compensate for failure to read the preamble to a key.

MICHAEL T. BARBOUR  
*EA Engineering, Science and Technology, Inc.*  
*Sparks, Maryland, USA.*

## ACKNOWLEDGEMENTS

The original manuscript and illustrations were prepared by J. K. Wickens and S. Smedley, respectively, funded by the F.R.E.D.Y. programme of the Department of Fisheries and Oceans, Institute of Ocean Sciences, Sidney, British Columbia. G. Greer provided management and advice to the project as administrator of the F.R.E.D.Y. programme.

Many colleagues across North America have provided advice, specimens, and distribution records from their own work, especially my generous reviewers M. T. Barbour, D. G. Cook, R. J. Diaz, R. D. Kathman, and D. R. Lenat. The author is indebted to all of the above for their invaluable assistance, and to R. D. Kathman for constant advice, support, and encouragement.



## INTRODUCTION

This group of animals has the reputation of being very difficult to identify. This is partly because taxonomists once believed it to be necessary to section every specimen before a complete identification could be made. By basing the keys on characters that can be observed from temporary or permanent whole mounted specimens wherever possible, this difficulty is avoided, though sectioned material is invaluable for advanced taxonomic work. The keys to the Tubificidae proceed directly to species without keying out the genera, because the definitions of genera are based largely on internal characters. About half the Tubificidae may now be identified from immature specimens, which is also facilitated by the procedure adopted, but mature specimens are required for the rest. This may sound as though it raises difficulties, but fortunately mature specimens of each species are almost always present in any community. It should also be remembered that these worms are hermaphrodites, and there are no larval stages, so a single key suffices for all specimens. Add to this the fact that there are less than forty species that form large populations known from the North American continent in fresh waters east of the Rockies, and the traditional attitude towards determining oligochaetes seems overstated but it will never be possible to identify them without making slide preparations.

The total number of North American freshwater species in all families is now about one hundred and fifty. It is still necessary for the systematist to be able to dissect these small worms and to study serial sections in attempting to describe new species and place them in the appropriate genera, but having done this the species can often be fitted into place in the key using only the superficial characters that can be seen in a whole-mount.

Lumbriculid species are often too large for normal slide mounts, and immature specimens are hard to identify. Many of the characters cannot be determined without dissection, but the family is of limited importance in terms of the number of species known and the number of specimens usually found at any one site. The single exception is a species that resembles a tubificid in appearance and can easily be identified under a stereoscopic microscope, Stylodrilus heringianus.

## Preparation of Material

The worms may be killed and preserved in 5% to 10% formalin or histological fixatives such as Bouin. After fixation for a day, they may be stored in 70% alcohol. Storage in homeopathic (patent lip) vials with neoprene stoppers prevents drying out. Do not add glycerol. When required for identification several options are available. For large routine collections I originally found that Amman's lactophenol was less drastic than glycerol and far less time consuming than permanent stained whole mounts. Soft parts may be destroyed in delicate specimens, and all histological detail is lost. The specimens can be readily removed from the slide for re-orienting, storage or dissection, even sectioning if not cleared for too long. They cannot be stored or mailed in this fluid medium, though some have tried as my "In Tray" will testify. The formula is:

Carbonic Acid	400g
Lactic Acid	400 mL
Glycerol	800 mL
Water	400 mL

The material is hygroscopic and should be kept for short periods in the dark or in brown bottles as it loses its efficacy after some months. Some biologists immerse whole samples in a vial of Ammans, but many prefer to make up large stacking trays, place two separate drops of Ammans on each microscope slide, and then immerse the worms (1-5 depending on size) in each drop. Each drop is then covered by a #1 coverslip. Some thin specimens can be examined immediately (especially under slight pressure), but it is better to leave them to clear for a day or so. Slight pressure on the cover slip will flatten the softened worms without destroying them, but care should be used.

Alternatively, more permanent mounts can be made with Polyvinyl lactophenol (Gurr product), Hydramount or CMC-10. These too are destructive media, and if worms are unstained the soft parts will not normally be useable, even if the worms are recovered by soaking slides in water. Permanent mounts can be made quite simply by staining (haematoxylin, rose bengal, etc.) dehydrating and clearing in xylol and/or methyl salicylate, and

mounting in Canada Balsam or artificial resins (Permount for example). Large specimens may be divided into head and tails and mounted under Ammans or other destructive materials (for chaetae) and the genital region, usually best regarded as VIII-XV, used for permanent mounts. Moderate to small worms should be whole mounted. Enchytraeids and marine tubificids must be permanently mounted as chaetae are of limited use. Mature naidids appear to be commoner in collections prepared in this way, and may be overlooked in temporary destructive media.

#### Examination of Whole Mounts

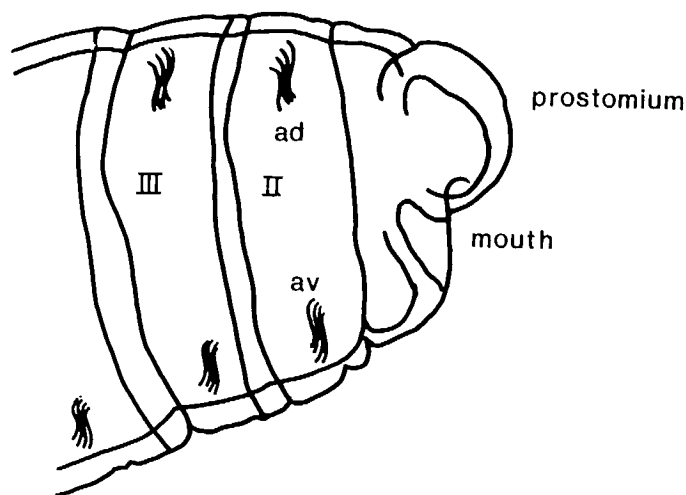

The first point to remember about the anatomy of the oligochaetes is that the first segment (labelled in roman numerals as I) is devoid of chaetae which are otherwise arranged in four bundles on each segment, two dorsolateral (termed dorsal) bundles and two ventrolateral (termed ventral) bundles. In many Naididae the dorsal bundles begin on a more posterior segment in fully developed specimens. It should, however, be stressed that when asexual reproduction occurs daughter individuals are budded off, and these frequently develop the most anterior segments last of all, so that some specimens may appear to have the dorsal chaetae starting in segment II when they are quoted in the key as being more posterior. With practice, these worms can be recognized as detached asexually-produced forms, from the absence of the prostomium, and in any case the parent specimen is usually present in the collection.



## Chaetae

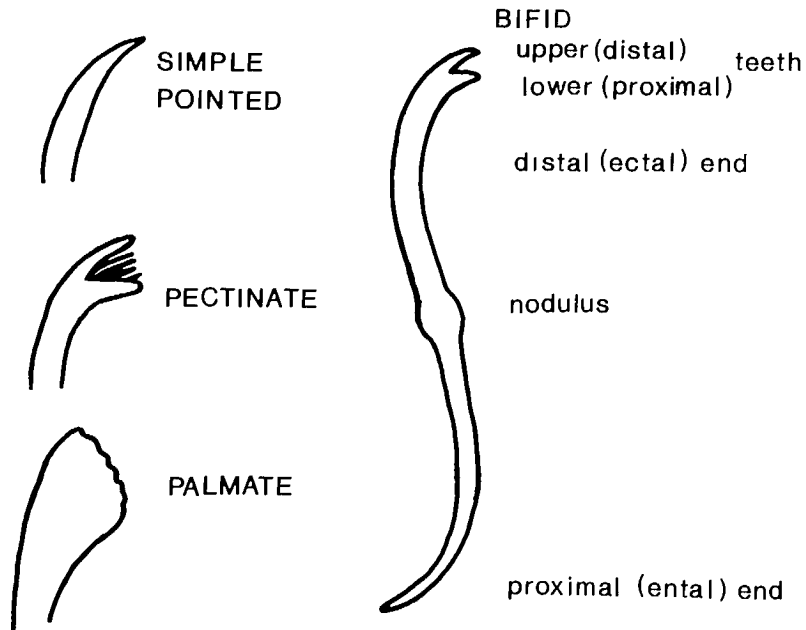

The principal features to study are the chaetae or setae. These terms are used as alternates, but the term chaetae does relate directly to the basic names oligochaete and polychaete. In an attempt to change the author's habits (which were affected in favor of setae some twenty years ago by an adamant referee), the term chaetae will be used here. The chaetae are of various forms, and any single specimen may exhibit several types in particular positions. Both dorsal and ventral chaetae from several parts of the body should be examined on each specimen prior to using the keys. Inspecting three bundles of chaetae on a segment ensures that both dorsal and ventral bundles have been examined.

Hair chaetae (capilliforms) are elongate, thin structures present only on the dorsal bundles of some naidids, opisthocystids and tubificids. They may bear fine lateral hairs (serrations) that are often only visible using good microscopes at high magnification (x100 objectives).

Bifid chaetae (crotchets) are found in both dorsal and ventral bundles in most worms. They are S-shaped, with the distal (ectal) ends bifurcate to a varying degree. The form and relative lengths of these teeth are commonly

referred to in the keys. Sometimes the upper distal tooth becomes so reduced as to be almost invisible, and this may be enhanced by wear. Dorsal chaetae in the naidids often differ from ventrals and are referred to as needles.

Pectinate or palmate chaetae are usually found in the presence of hair chaetae where those are present, in dorsal bundles in the Naididae and Tubificidae. They consist of bifids with a set of fine intermediate teeth which may merge to form a web between the main teeth. When the intermediate and outer teeth become equally large the chaetae are termed palmate. Ventral chaetae in some tubificids may show traces of intermediate teeth in a few anterior bundles but little or no emphasis is placed on this feature.

Simple pointed chaetae are rare in the freshwater worms, but are found in lumbriculids, in some anterior ventral bundles of tubificids like Spirosperma species, and in the dorsal bundles of some naidids in association with hair chaetae.

Unusual chaetae make some species instantly recognizable. The teeth of the bifids are side by side in the lumbriculid Rhynchelmis brooksi from Alaska. In Telmatodrilus vejovskyi (Pacific coastal region) the posterior chaetae have large numbers of small denticles on them in place of the upper tooth. There are oar shaped chaetae in mid dorsal bundles in Aulodrilus pigueti and bifids with lateral flanges in A. limnobioides. The last three are all tubificids.

Genital chaetae are usually associated with the genital pores of mature specimens. Those accompanying or adjacent to the spermathecal pores (spermathecal chaetae) are usually solitary, large, and have blade or gutter shaped ectal ends made of the greatly modified teeth of their bifid ancestral form. Spermathecal chaetae are commonly found in segment X (ninth chaetal bundle) in place of the normal chaetae of the ventral bundles in tubificids. They are found further forward in naidids (Piguetiella, Pristina). The spermathecal chaetae look as though they act to facilitate the transfer of sperm into the spermathecae of the concopulant, but their function has not been established. Penial chaetae are often numerous in each ventral bundle, commonly on XI in tubificids, and the distal ends are blunt, often swollen

with the teeth more or less fused together. The inner ends may be elongate, straight, and arranged fan-wise such that the outer tips are brought together so that they probably act as claspers.

Note that genital chaetae (and other reproductive organs of course) are present in mature specimens. The recognition of mature animals will be discussed below.

Most chaetae have a more or less median swelling referred to as the nodulus. This is absent from the hair chaetae and from many simple pointed chaetae. Chaetae are distributed in the various families as follows:

#### Haplotaxidae

One of the two North American species has only 2 or 4 chaetae per segment, the ventrals large and sickle shaped, the smaller, straighter dorsals missing from a variable number of segments. The other has paired simple pointed chaetae (it is limited to a single cave).

#### Opistocystidae

The dorsal bundles have several hair chaetae and single pointed chaetae, the ventral bundles several bifid chaetae.

#### Lumbriculidae

Chaetae all bifid with reduced upper teeth, or simple pointed, rarely both in one species. Chaetae always 2 per bundle (8 per segment) but replacement chaetae may sometimes be present before the old chaetae are shed.

#### Naididae

ventral chaetae only (Chaetogaster in part)  
or dorsals and ventrals with bifids only



or ventrals bifid but dorsals with hairs plus simple, bifid, pectinate or palmate chaetae

The dorsal chaetae may begin in II, III or further back, usually V or VI, rarely in XVIII or beyond.

#### Tubificidae

dorsal and ventral chaetae bifid

or dorsal chaetae hairs and pectinates, ventrals mostly bifid. (Pectinates may be narrow, hairlike distally).

or dorsal hairs and bifids, ventrals bifid. Chaetae begin in II.

#### Enchytraeidae

Most species have two simple pointed chaetae per bundle, but many have several, sometimes differing in length and breadth within each bundle. Chaetae may be sigmoid or straight, and may lack a nodulus. Some species lack chaetae altogether, and some marine species lack a variable number of dorsal chaetae. Propappus, which has bifid chaetae, is no longer considered a member of this family.

#### Other families

Most other families are rarely or only incidentally found in aquatic habitats. All of the earthworm families have 2 simple pointed chaetae per bundle. The parasitic branchiobdellids and the leeches have no chaetae. The aquatic Aeolosomatidae have hair chaetae in both dorsal and ventral bundles.

#### Reproductive organs

A mature worm can usually be recognized by the enlargement of the genital area (in the region of segments V-VIII or X-XII). The body wall is thick and glandular where the clitellum is developed around the genital pores (unlike

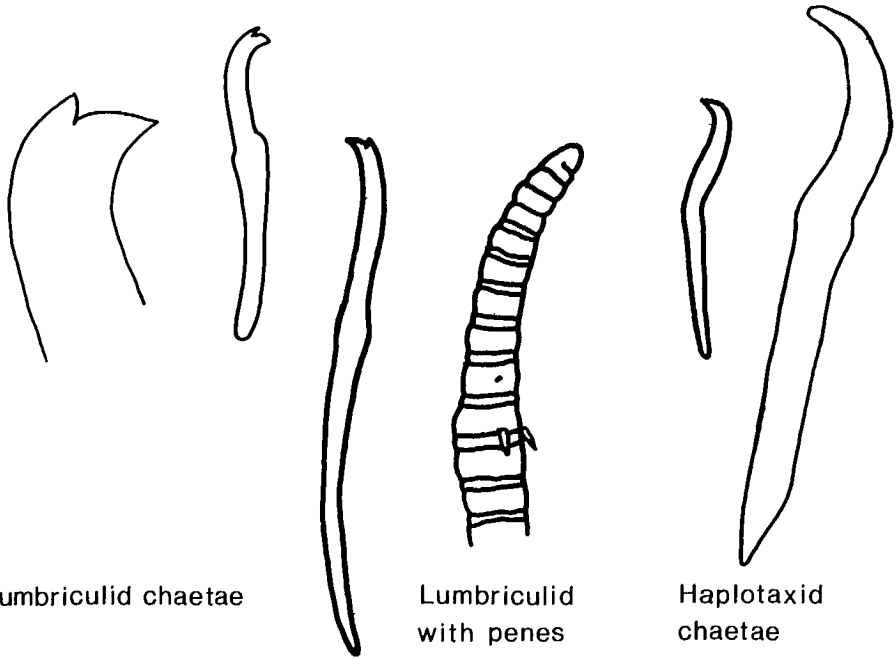

Lumbricid chaetae

Lumbricid with penes

Haplotaxid chaetae



Tubificid dorsal chaetae

Naidid dorsal chaetae (needles)

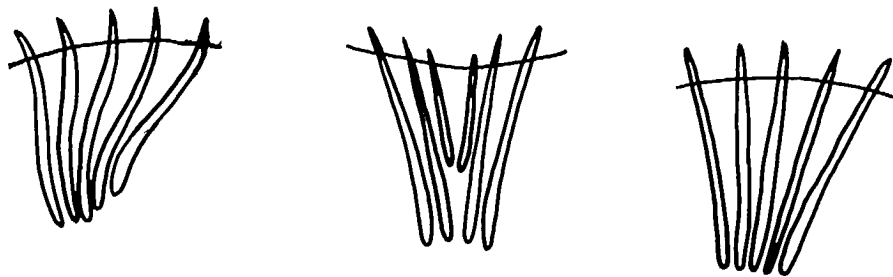

Enchytraeid chaetae

earthworms in which the clitellum is even thicker but is located much further back along the worm, often around XXX). The stored eggs and sperm in their storage sacs around and behind the clitellar region often appear milky white in live specimens. This material, together with the spermathecae (and their contained sperm in mated worms) and male ducts, is clearly absent in immature worms in which the gut can be traced right through the genital region with little or no sign of other organ systems than blood vessels.

The following figure shows the basic plan of the genitalia in the majority of Tubificidae. The paired spermathecae lie in segment X together with the paired testes. Spermathecae are absent in Bothrioneurum. Sperm may be free in the spermathecae or gathered into bundles called spermatozeugmata.

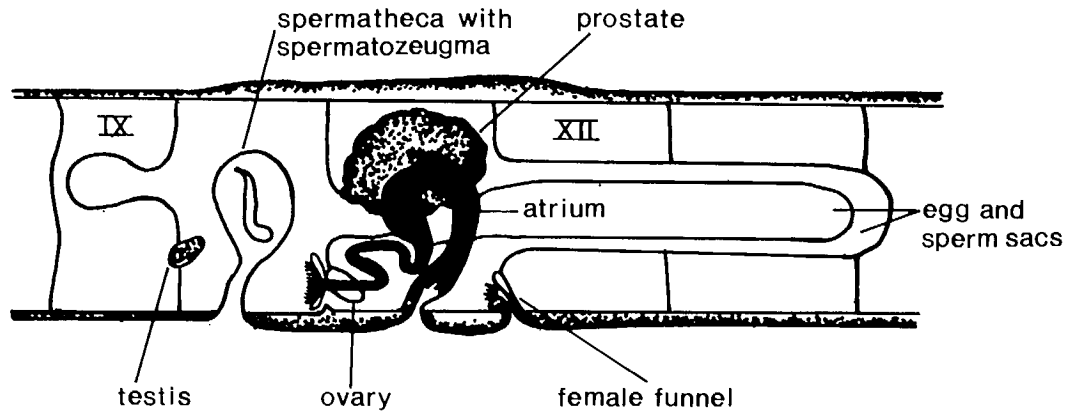

The eggs and sperm are released from the gonads (one pair of each in the naidids and tubificids, often more in the lumbriculids and haplotaxids) into the coelom. From there they find their way to the exterior via ciliated funnels. The female funnels open directly to the exterior. The male funnels usually lead into a ciliated vas deferens that terminates in a muscular atrium. This may end in a penial structure of some description, sometimes at the end of an ejaculatory duct. Parts of these structures may bear prostate glands. Sperm is stored and fed by the male ducts and is transferred to the spermathecae of a mate (or may be packaged and attached to the body wall in Bothrioneurum).



The sperm sacs are paired and are developed from the intersegmental septa 9/10 and 10/11, the posterior sperm sacs entering the egg sacs on the intersegmental septum 11/12. Note that septa are referred to by Arabic numerals representing the two segments that they separate. The posterior sperm sacs and the egg sacs may project through several segments, i.e., from segment X to segment XII or XIII. The sperm funnels lie in segment X but most of the vas deferens lies in segment XI. The vasa deferentia may be elongate, and then partly fill the posterior sperm sacs on each side. A solid prostate gland may be attached to the atrium by a short stalk. In some genera there is a series of separate prostate cells ensheathing the atrium, or a group of stalked prostates. There may or may not be a true penis, which may or may not be ensheathed in cuticle. The ovaries lie close to the vas deferens, on the intersegmental septum 10/11, in segment XI. The oviducts are very short, passing through the septum 11/12 to open at the anterior end of segment XII.

The penes of tubificids are formed from an infolding of the body wall and are therefore covered in cuticle. This may be no thicker than normal body wall cuticle, but where it is thick enough to be seen in cleared whole mounts as a distinct structure it is termed a cuticular penis sheath (Tubifex for example). Holmquist (1985) reserves this term for the heavily thickened penis sheaths that appear to have become separated from the soft tissue within them (Limnodrilus). In yet other examples, the distal lining of the male duct (Psammoryctides) may look like a crumpled penis sheath, or the thickened, but internal, basal membrane of penial muscles may also be visible in whole mounts. Such structural differences may be important in evolutionary studies but here they will be referred to as penis sheaths or apparent penis sheaths with no other qualification.

The differences in the reproductive systems of the three major families that have a single pair of testes and ovaries in succeeding segments is illustrated below (Naididae, Tubificidae, Enchytraeidae), though mature specimens of naidids are not common because asexual reproduction by budding (or fragmentation) is a more usual mode of reproduction for at least part of the year. Note the segments normally occupied by the gonads (this does vary a little, especially in naidids) and the position of the spermathecae in the enchytraeids.

NAIDIDAE

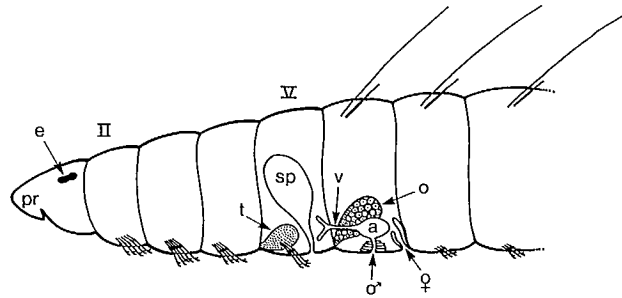

LEGEND

- pr - prostomium
- e - eye spot
- sp - spermatheca
- t - testis
- o - ovary
- v - vas deferens
- a - atrium
- pt - prostate
- ♂ } genital pores
- ♀ }

TUBIFICIDAE

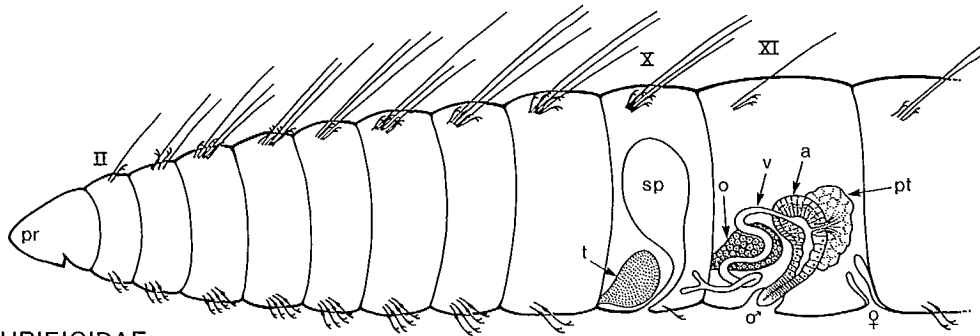

ENCHYTRAEIDAE

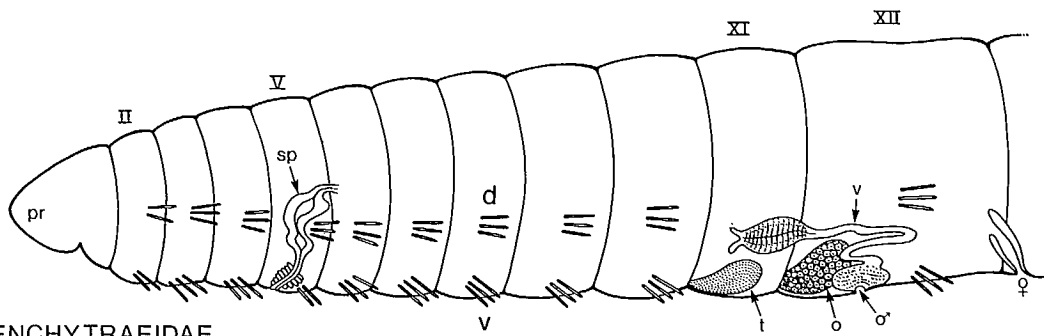

## Evolution and Classification

The evolution of oligochaetes has been reviewed elsewhere (Brinkhurst 1982, 1984a,b) based on classical morphological arguments. The following diagrams are an initial attempt to present a phylogeny more in line with Hennigian concepts (Wiley 1981) which insist on grouping together all of the descendents of each dichotomy into hierarchical classification schemes, with sister groups having equal rank. The dichotomies are established on the basis of shared advanced (apomorphic) characteristics in these schemes, primitive (plesiomorphic) characters common to sister groups being omitted, as opposed to those methods that employ total similarity.

This initial hypothesis and the classification that results from it is based on only a few traditionally used characters, and has been hand compiled. This may result in a greater degree of subjectivity than might be the case of a computer analysis using more characters, though that assumption could be challenged on the basis that character selection is always influenced by tradition and that computer methods may present multiple solutions rather than a unique phylogeny.

The purpose of presenting these diagrams is that they provide a logical basis for the proposed classification used in the check list that follows. Careful cataloguing of characters for entry into data matrices for manual or computerized analysis reveals falacious assumptions that are embedded in the literature. For example, Propappus is not only an impossible ancestor for the Enchytraeidae, but also cannot be incorporated within that family; the Family Enchytraeidae has more species with 2 chaetae per bundle than species with more; very few lumbriculids have multiple gonads and those that do have an unstable number and are parthenogenetic.

There is no evidence to suggest that hair chaetae evolved only once in the Annelida, a supposition based on the naive logic that polychaetes are basically like Nereis and, being marine and having larvae, must be ancestral to the terrestrial earthworms, which resemble Lumbricus. All of this flows from our earliest education based on commercially available classroom

representatives of taxonomic groups which are, almost without exception, poor biological representatives of those groups.

Obvious problems arise in relation to the ranking of the Arthropoda and Annelida, which could be considered to be the equivalent of a single phylum, but this is denied on the grounds of both tradition and practicality.

The Pogonophora (including Vestimentifera) are not included although they may still be considered as relatives of the Annelida in view of the segmented, possibly chetate, opisthosome.

The leeches and allies are considered to have basically prosopore male ducts and testes that were originally anterior to the ovaries but which have become secondarily posterior to the ovaries by extension through the sperm sacs. These are the bases for the long-suggested relationship between leeches and lumbriculids. Indeed, in Hennigian terms these two taxa should be classified together within the Lumbriculida if the lumbriculids do provide a direct ancestor to the leeches. The resemblances between the male ducts could be due to convergent development of the prosopore state, and more details must be studied in this as in other instances.

The Aphanoneura were originally classified as a subclass of the Clitellata, but Brinkhurst (1982) classified the Oligochaeta, Aphanoneura and the Hirudinea at the class level, following the decision imposed by Parker (1982) to bring the group in line with other classifications in a major synthesis of the animal kingdom. The Clitellata could include the Aphanoneura if they have secondarily lost the usual dorso-lateral clitellum. The Hirudinoidea may be granted the status of Class (see Parker 1982) because of the degree of deviation from their supposed oligochaete ancestors despite the requirements for sister groups to be of equivalent rank.

Among the Tubificida, the multichetate condition and the presence of hair chaetae in dorsal bundles have arisen more than once as the main line of ancestral forms leading to the dorydrilids and lumbriculids retains the lumbricine bichetate condition. Propappus may be a derivative of an early enchytraeid line, separating before the reduction of the gonad sequence (the

possession of all 4 pairs of gonads being characteristic of all of the ancestors of the various families). The opisthocystids have prostates on the atria, an advance over the phreodrilids, and they are probably an independent line, perhaps even derived from the Naididae. The Tubificidae and Naididae have always been regarded as close - they probably should be regarded as a single family in fact, as the Hennigian rules would suggest. An ancestral dorydrilid with 4 pairs of gonads would need to become prosopore in order to give rise to the lumbriculids; the two families were combined until quite recently.

In this presentation groups share ancestors with other groups but are not themselves directly ancestral to one another. The common ancestor of the Lumbricina and the Haplotaxina would undoubtedly be classified as a simplified haplotaxid, but we should not expect to find living fossils throughout the group. Some use is made of conventions 2 and 3 of Wiley (1981) which allow for conservation of traditional ranks and classification of a sequential series of taxa at equivalent ranks.

The subfamilial rankings of the Naididae are being analysed and will be discussed elsewhere. Subfamilies will be listed for the Tubificidae but no phylogeny is proposed here.

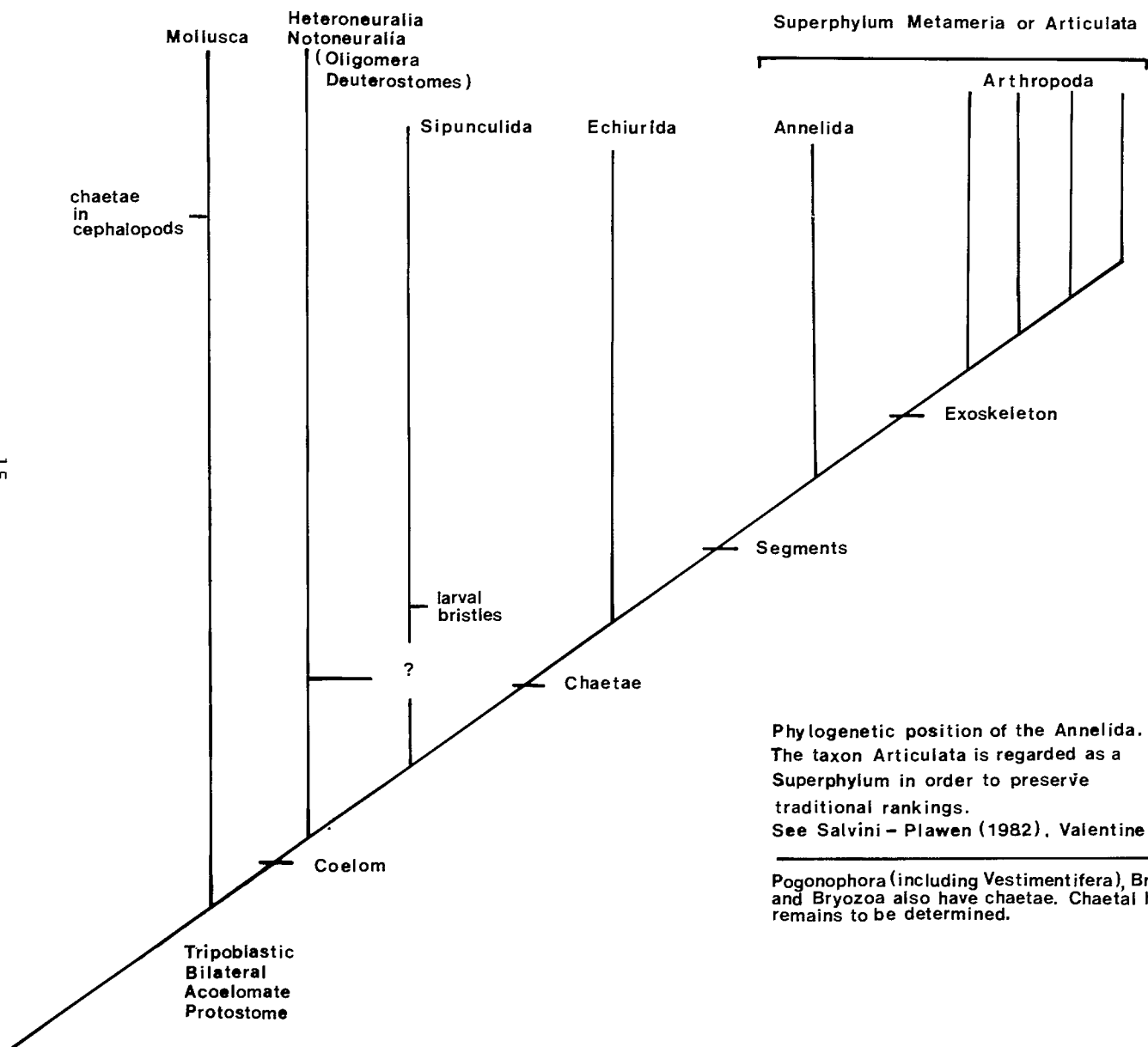

Phylogenetic position of the Annelida.  
 The taxon Articulata is regarded as a  
 Superphylum in order to preserve  
 traditional rankings.  
 See Salvini-Plawen (1982), Valentine (1973)

Pogonophora (including Vestimentifera), Brachiopoda  
 and Bryozoa also have chaetae. Chaetal homology  
 remains to be determined.

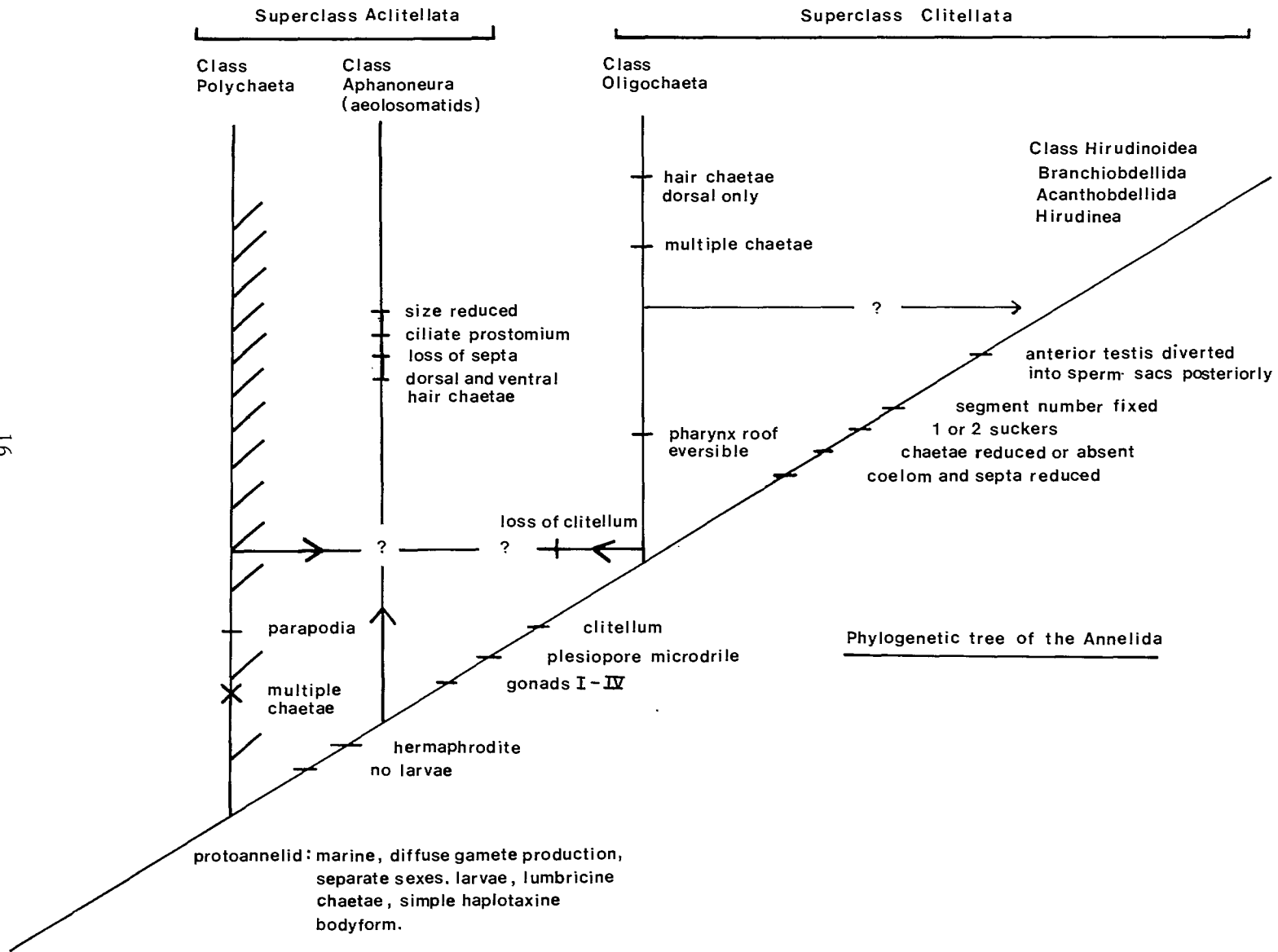



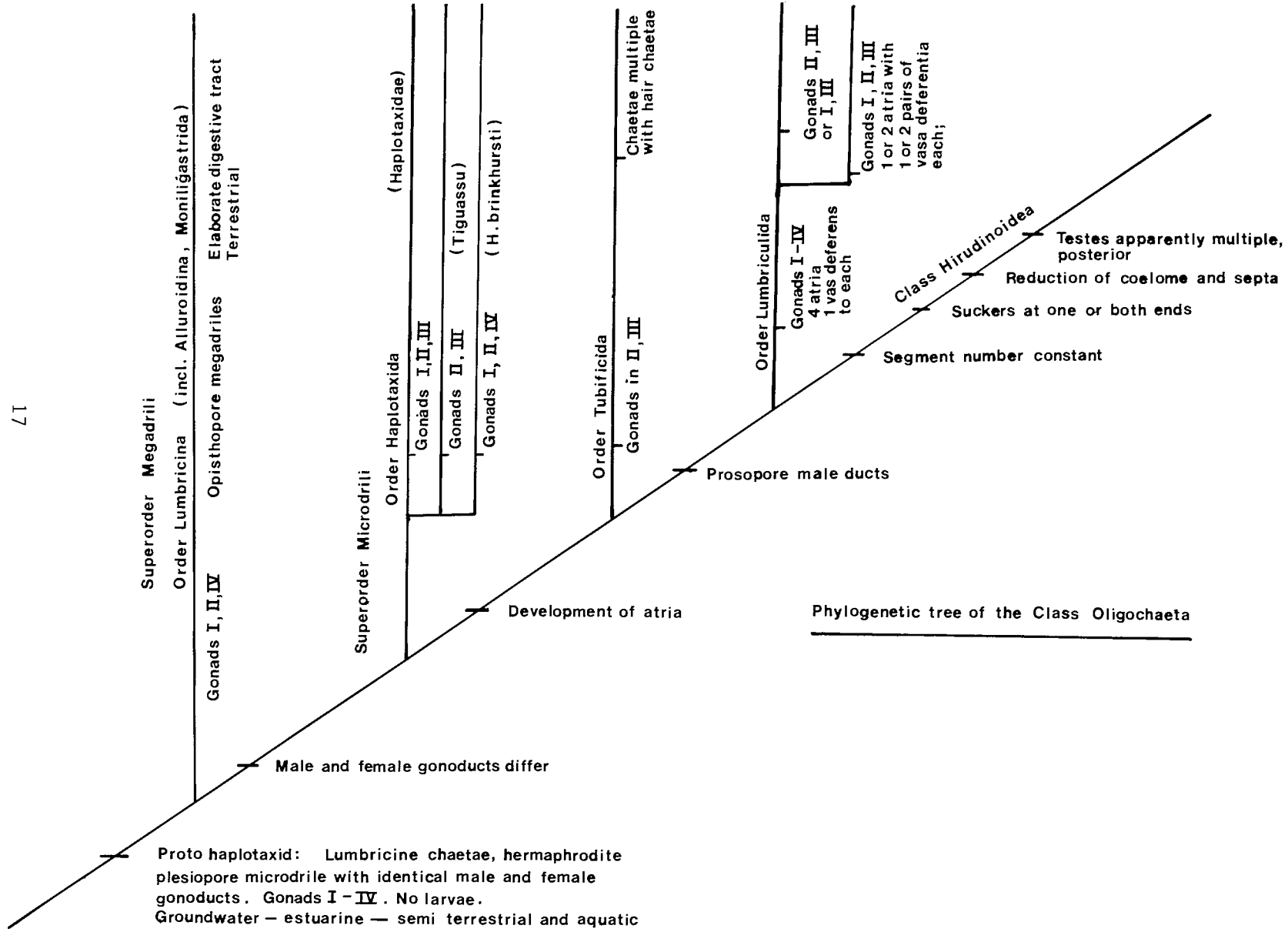

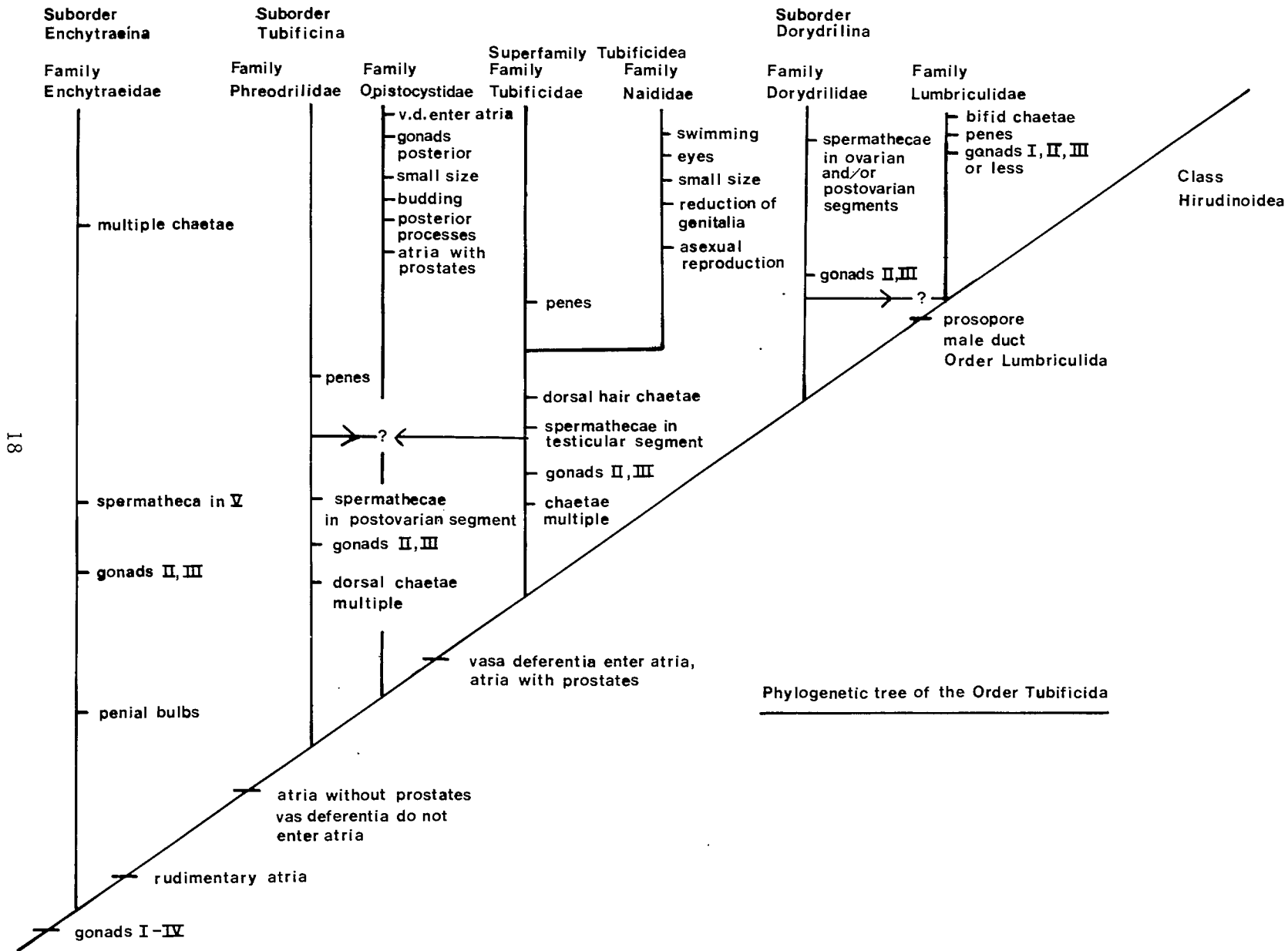

CLASSIFICATION AND CHECK LIST OF NORTH AMERICAN FRESHWATER AQUATIC  
OLIGOCHAETES (MICRODRILI)\*.

Superorder Microdrili	Piguetiella blanci
Order Haplotaxida	P. michiganensis
Family Haplotaxidae	Specaria josinae
Haplotaxis gordioides	S. fraseri
Haplotaxis brinkhursti	S. hellei
(?=Metataxis brinkhursti)	Pristina leidyi
Order Tubificida	P. aequiseta
Suborder Enchytraeina	(?P. proboscidea)
Family Enchytraeidae	P. breviseta
Suborder Tubificina	P. plumaseta
Family Opistocystidae	p. synclites
Crustipellis tribranchiata	P. americana
(Opistocysta flagellum sp. inq.)	Ripistes parasita
Superfamily Tubificoidea	Stylaria lacustris
Family Naididae	Arcteonais lomondi
Chaetogaster diastrophus	Haemonais waldvogeli
C. diaphanus	Dero (Allodero) hylae
C. setosus	D. (A.) floridana
C. limnaei	D. (Dero) digitata
Homochaeta naidina	D. (D.) obtusa
Amphichaeta leydigi	D. (D.) nivea
A. americana	D. (D.) pectinata
A. raptisae	D. (D.) trifida
Paranais litoralis	D. (D.) abbranchiata
P. frici	D. (Aulophorus) furcata
P. birsteini	D. (A.) lodeni
P. grandis	(=D. (A.) pectinatus)
Ophidonais serpentina	(=D. (A.) intermedius)
Uncinaiis uncinata	D. (A.) flabelliger
	D. (A.) vaga

\* (?Name name: doubtful record) (=Name name: synonym)

(sp. inq.: dubious species) (?=Name name: probably synonym)

Allonais pectinata  
 A. paraguayensis  
 (?A. inaequalis)  
 Slavina appendiculata  
 Vejdovskyella comata  
 V. intermedia  
 Nais magnaseta  
 N. behningi  
 N. pseudobtusa  
 N. barbata  
 N. alpina  
 N. simplex  
 N. pardalis  
 N. bretscheri  
 N. elinquis  
 N. communis  
 N. variabilis  
 Stephensoniana trivandrana  
 Bratislavia bilongata  
 B. unidentata  
 Pristinella longisoma  
 P. osborni  
 P. minuta  
 P. sima  
 (?P. notopora)  
 P. longidentata  
 P. jenkiniae  
 (=P. idrensis)  
 P. acuminata

Family Tubificidae  
 Subfamily Tubificinae  
 Tubifex tubifex  
 T. ignotus  
 T. nerthus  
 (?=T. newfei)  
 (T. fissidens sp. inq.)  
 (Lophochaeta paucipilifer  
 sp. inq.)  
 T. harmani  
 (Kopilrok flexipenis gen.  
 et. sp. inq.)  
 (K. sagavanirktoki sp. inq.)  
 Isochaetides freyi  
 I. curvisetosus  
 I. columbiensis  
 (I. hamatus sp. inq.)  
 Psammoryctides barbatus  
 P. californianus  
 P. convolutus  
 Potamothrix moldaviensis  
 P. vejdovskyi  
 P. bedoti  
 P. bavaricus  
 (?P. hammoniensis)  
 Limnodrilus udekemianus  
 L. rubripenis  
 L. silvani  
 L. profundicola  
 L. hoffmeisteri  
 L. angustipenis

L. claparedianus	Subfamily Telmatodrilinae
L. cervix	Telmatodrilus vej dovskyi
L. maumeensis	T. onegensis
L. tortilipenis	Subfamily Rhyacodrilinae
Ilyodrilus perrieri	Rhyacodrilus coccineus
I. templetoni	R. sodalis
(I. fragilis sp. inq.)	R. montana
I. frantzi	R. brevidentatus
Teneridrilus mastix	R. falciformis
Varichaetadrilus pacificus	(R. punctatus sp. inq.)
V. nevadana	Bothrioneurum vej dovskyanum
V. fulleri	Rhizodrilus lacteus
V. psammophilus	Branchiura sowerbyi
Arctodrilus wulikensis	Subfamily Phalloodrilinae
Haber cf. speciosus	Phalloodrilus hallae
Spirosperma ferox	Order Lumbriculida
S. nikolskyi	Family Lumbriculidae
(=S. variegatus)	Kincaidiana hexatheca
(?=S. oregonensis)	K. freidris
S. carolinensis	Rhynchelmis brooksi
S. beetoni	R. elrodi
Quistadrilus multisetosus	(R. glandula sp. inq.)
Aulodrilus limnobius	(R. alaskana sp. inq.)
A. pluriseta	R. rostrata
A. pigueti	(=R. alpestris)
A. americanus	Trichodrilus allobrogum
A. paucichaeta	T. culveri
	T. allegheniensis

Eclipidrilus (Eclipidrilus) asymmetricus  
E. (E.) frigidus  
E. (Premnodrilus) palustris  
E. (P.) daneus  
E. (Leptodrilus) lacustris  
E. (L.) fontanus)  
Lumbriculus variegatus  
(L. inconstans sp. inq.)  
(L. ambiguus sp. inq.)  
L. genitosetosus  
Stylodrilus heringianus  
S. beattiei  
S. sovaliki  
Spelaedrilus multiporus  
Styloscolex opisthothecus

## BIOLOGY

This section is intended to give the reader some idea of the habitats in which worms can be found. Detailed biological reviews are available in books by Brinkhurst & Cook (1979), Jamieson (1981) and Mill (1978).

### Naididae

About seventy species are known in North America (Brinkhurst & Kathman 1983).

Representatives of this family are small, usually less than two centimeters long, but they form chains of individuals that may appear longer. Some are found as infauna in muddy sediments in ponds and lakes, while others are epifauna associated with algae or higher plants. These species are obviously common in ponds, canals and quiet stretches of rivers, and protected bays in lakes. Naidids are often an important part of the fauna of small stony streams (e.g. Pristina, Pristinella, Nais and others) where tubificids are less abundant .

Some species have a pair of simple eyes, which are not found in other families. Several have a long projection of the prostomium called a proboscis, a feature found in some lumbriculids (which are usually much larger worms) but not in tubificids. Gills are present at the posterior end in Dero species.

### Tubificidae

Fifty-eight species have been reported in fresh water in the U.S.A. and Canada and many more (not included here) in estuaries and the ocean.

Some species are sold as fish-food in aquarium stores and are found in such abundance in organically polluted situations that they often coat the entire surface of the sediment. Other species are limited to uncontaminated situations, and a range of sensitivities to stress factors can be determined. These worms, usually but not always more than two centimeters long, often



wind around the meshes of nets and screens, and may form coils in a dish. When exposed to light in a dish they usually form a ball with heads hidden in the center and the tails projecting, but the clumps may break up if the dish is placed in a dark place. They play a significant role in bioturbation of freshwater sediments, and hence play a role in geochemical and microbiological processes. In pollution biology, work has progressed from the search for indicator species to indicator associations that are quantitatively determined, to the contribution their identity can make to ordination and cluster analyses of species by station data matrices.

#### Enchytraeidae

These worms are about the same size as the tubificids, but the body wall has a thick cuticle and so the worms seem stiffer and less transparent in many species. Many are terrestrial but others may occupy saturated soils or aquatic habitats. The identification of species in this family depends on the examination of the soft parts as well as the chaetae, and taxonomists use properly fixed material that is stained and permanently mounted. There is no recent review of the North American freshwater representatives of the family, and so it is only possible for most biologists to separate them from tubificids, which is a very simple matter.

#### Lumbriculidae

There are twenty North American lumbriculid species, but several are known only from Alaskan or western localities, several others are limited to caves and springs.

Most of these worms are longer, thicker and more robust than the tubificids or enchytraeids. They are intermediate in size between these smaller aquatic worms (such as the familiar Tubifex) and an average earthworm. Like the earthworms, there are only two chaetae in each bundle, either simple pointed or bifid with only a very weak upper tooth. Only two species are common in the continental U.S. and lower Canada. Lumbriculus variegatus is of variable length, but is often several centimeters long. It fragments readily. The front end often has a greenish hue in life, but the

rest of the worm is red. The chaetae are indistinctly bifid. The body of the worm is somewhat unusual in shape in that it does not seem to taper towards the tail, but remains much the same thickness throughout. Mature worms are scarce. This worm is common in shallow water among leaves, sticks, stones and rooted plants but it may also be found in other habitats. It is becoming economically important as the "black worm" derived from trout farms and sold to aquarium fish dealers.

The second lumbriculid is Stylodrilus heringianus, a tubificid-sized worm which is separable from members of that family by the pair of chaetae in each bundle and the finger-like soft penes projecting from the tenth segment (ninth chetigerous segment) on the ventral side. This worm may have been introduced from Europe, where it is common mainly in stony substrata in unproductive rivers and lakes, but it is now widespread in North America.

These two are the only members of this holarctic family to have been introduced to the southern hemisphere.

#### Haplotaxidae

Haplotaxis gordioides is the only representative of the family likely to be encountered, and then in groundwater in most instances. It has never been identified for certain from North America, but immature worms resembling it have been found in a number of places. The species is very long (up to 30 cm), very thin, and has a large prostomium with a transverse groove. The chaetae are very unusual, with large single sickle-shaped chaetae (or paired when new chaetae are developing) in the ventral bundles. The species is very rare, mature specimens even rarer. A second species (H. brinkhursti) has been found once, in a cave. It has chaetae like those of an earthworm, eight simple pointed chaetae per segment.

#### Opistocystidae

Worms belonging to this family are small, again very rare. They are immediately recognizable as the posterior end bears three processes of variable length.

## Branchiobdellidae

This family consists of parasites of crayfish. They have no chaetae and are no longer classified as oligochaetes, but as part of the Hirudinoidea.

## Aeolosomatidae

These small worms, with their ciliated prostomium, and spots of colour in the otherwise transparent colourless body, are usually only noticed in aquaria. Their length is usually measured in millimeters, and their delicate bodies are not usually noticed in preserved samples. The ecology of the group is largely unknown.

They are now considered to be Aphanoneura and are excluded from this key. Eight species were recorded by Brinkhurst & Cook (1966).

## USE OF THE KEYS

This set of keys adopts a style between those of the familiar dichotomous and tabular keys. At each step the reader is required to choose from among two to five options. These options usually involve several characteristics unless one is clear and reliable. Keys will proceed either to genera and then species where relevant (Naididae for example) or to species groups based on clearly visible features. In both instances the key concludes with a genus by genus account which includes brief descriptions for checking the results obtained using the key. With practice, the earlier sets of decisions in each key will be skimmed rapidly. In some instances zoogeographic data or habitat descriptions are used in the keys (it is easy to exclude an eastern cave dwelling species if studying streams on the west coast, for example). The aim is to provide swift and self - checking identifications. Users who are familiar with dichotomous keys may find that they work harder with this key, but I suggest they will learn more about the group in the process.

I have tried to use simple terminology, preferring hair to capilliform, bundle to fascicle, and so on. The choice of chaeta over seta is a personal preference, but the change is clearly optional.

I believe that there are unpublished records of other North American species which cannot be included here. Such species can be identified by reference to the world monograph along with its recent update (Brinkhurst & Jamieson 1971, Brinkhurst & Wetzel 1984). The latter should be used to check nomenclature changes as well as new taxa described from 1971-82. This warning applies more to the Naididae, in which a few widespread species are still missing from the North American list, especially in Pristina and Pristinella.

Illustrations were re-drawn from the original descriptions, or from other illustrated keys that include original and copied illustrations (Cekanovskaya 1962, Hrabe 1931). This involves the work of the author and his students (D.G. Cook, H.R. Baker, P.M. Chapman and C.R. Kennedy) and of such authors as: O.V. Cekanovskaya, Y. Chen, N. Giani, W.J. Harman, C. Holmquist, S. Hrabe, M.S. Loden, E. Marcus, E. Piguet, D.R. Spencer, C. Sperber, F. Vejdovsky, M.J. Wetzel, and J.T. Wassel.

Figure legends used:

1. Chaetae

a - anterior	d - dorsal	e - enlarged (or giant)
g - genital	h - hair	p - posterior
pc - penial	sc - spermathecal	v - ventral

2. Reproductive system

a - atrium	e - ejaculatory duct	f - female funnel
g - gland	m - male duct	o - ovary
pt - prostate	t -(or o) testes	p - penis or penis sheath
sp - spermathecae	sz - spermatozeugma	v - vas deferens

3. Other

II, III etc. - segments	b - branchial fossa
pr - prostomium	w - papillate body wall
- male pore	- female pore

Note: Letters can be combined (e.g. av=anterior ventral). Scales are in mm unless otherwise stated.  $\mu\text{m}$  will be used to represent  $\mu\text{m}$  throughout.

## KEY TO FAMILIES

1. Locomotes by means of a ciliated prostomium. Septa reduced or absent. Hair chaetae in dorsal and ventral bundles. Often with coloured oil droplets in epidermis. Rarely sexually mature, when mature with ventral copulatory gland but no clitellum (Minute delicate worms).

Class Aphanoneura (Aeolosomatidae & allies)

Locomotes by means of muscular body wall and segmented coelom. Hair chaetae restricted to dorsal bundles if present. Without coloured oil droplets. Mostly reproduce sexually (but see Naididae), body wall forming a clitellum (size varies from small to as robust as earthworms).

Superclass Clitellata, Class Oligochaeta 2

2. Chaetae restricted to a pair in each of 4 bundles per segment (in 1 species the chaetae are reduced to 4 per segment, the dorsals being much smaller than the ventrals, and the dorsals may even be missing from a number of segments). Mostly large, robust worms up to earthworm size apart from one or two small lumbriculids \*.

3

Chaetae mostly numerous in each bundle, hair chaetae present or absent in dorsal bundles. Mostly small worms (can be mounted whole on microscope slides).

5

3. Elongate, thread-like worms up to 400mm long with strongly sickle-shaped large solitary ventral chaetae and smaller solitary dorsal chaetae that may be absent from some segments or worms 25-30mm long with paired sigmoid simple pointed chaetae with ventrals of II-VIII/X slightly larger than dorsals, those of X-XXV or XXXIV distinctly longer than dorsals. Groundwater species.

Haplotaxidae

p.31

\*Some enchytraeids have 2 chaetae per bundle but the chaetae may be straight and may lack a nodulus. See description of the Family.

Worms of more usual proportions with chaetae all alike, sometimes bifid with reduced upper teeth (one species with bifid and simple pointed chaetae).

4

4. Large worms, the familiar earthworm size. Chaetae 2 per bundle, all alike, simple pointed and slightly sigmoid, with a nodulus. Male pore behind the two testicular and single ovarian segments, often on XIV. Clitellum thick, multicellular. Eggs small, non yolky. No proboscis.

Earthworms, including the aquatic Sparganophilus and Eiseniella tetraedra.

Moderately large worms up to 4 cm long and 1-3 mm broad, less robust and with thinner body walls than earthworms. Chaetae 2 per bundle, usually all alike, which may be simple pointed or may be bifid with short, thin upper teeth that may be rudimentary, in one instance anterior chaetae bifid, posterior chaetae simple pointed. Male pores in the same segment as the testes. Clitellum one cell thick. Eggs large, yolky. An anterior proboscis may be present.

Lumbriculidae

p.209

5. Tail end with 1 median and 2 lateral short processes, but no gills. Dorsal bundles with hair chaetae accompanied by simple pointed needle chaetae. 1 uncommon species.

Opistocystidae

p.35

Tail end without processes of any sort, or with gills that may be accompanied by long ciliated palps (1 subgenus, Aulophorus). Hair chaetae present or absent in dorsal bundles. When present hair chaetae may be accompanied by simple pointed needles but more often by bifid to pectinate or palmate chaetae.

6

6. Chaetae simple pointed, may lack a nodulus, and may be straight, numbering from 2 to several per bundle, but dorsals and ventrals the same. Sometimes long and short straight chaetae in the same bundle. Chaetae may be totally

absent. Spermathecae in V, male pores on XII.

Enchytraeidae

p.24

Simple pointed chaetae absent, or limited to a few anterior ventral bundles. Ventral chaetae normally bifid and several per bundle. Dorsal chaetae either like ventral, or dissimilar with hair chaetae accompanied by bifid, pectinate or palmate chaetae, from 1 of each to several per bundle. Spermathecae in the testicular segment, male pores varying from V to XI but never XII.

7

7. Length usually measured in millimeters. Hair chaetae when present accompanied by chaetae which usually differ markedly from the ventrals. Dorsal chaetal bundles may begin somewhere between II and VI or even posteriorly. Ventral bundles with numerous bifid chaetae, those of II or II-V often quite different to the rest. Asexual reproduction common. Mature forms with spermathecae in IV, or V, or VII, male pores one segment behind them. Eyes may be present. The prostomium may bear a proboscis. Paired ciliated gills may be present around the anus.

Naididae

p.39

Length may be measured in centimeters, width almost 0.5-1.1 mm. Hair chaetae when present, usually accompanied by pectinate chaetae, sometimes by bifids, in either instance the dorsal chaetae resemble the ventrals in general form and the ventrals may even have rudimentary pectination. Dorsal chaetae begin in II. Ventral bundles with numerous bifid chaetae, very occasionally some simple pointed chaetae anteriorly. Reproduction usually sexual, with spermathecal pores on X. Male pores on XI in most instances. No eyes. No proboscis. Gills absent, or present on the posterior segments as single mid-dorsal and mid-ventral projections.

Tubificidae

p.109

## HAPLOTAXIDAE

This family is considered to contain the most primitive oligochaetes known, though many do show their own advanced features. There are two pairs of testes and two pairs of ovaries in succeeding segments in many species, and the male and female gonoducts are very simple and quite similar in the most primitive species. In one North American species the first pair of ovaries is missing, foreshadowing the condition seen in earthworms in which the male ducts penetrate more than one septum.



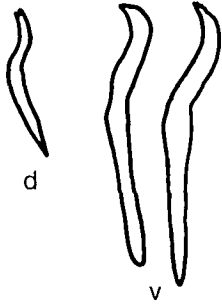
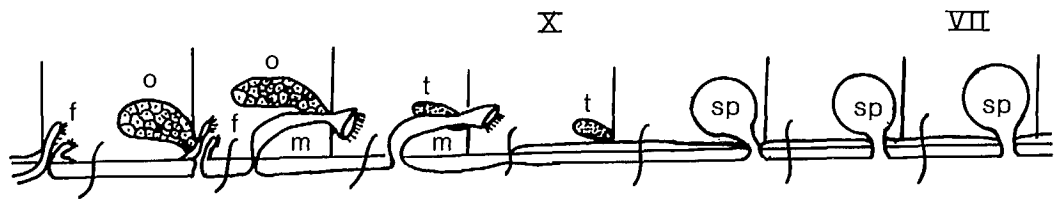

*H. gordioides*

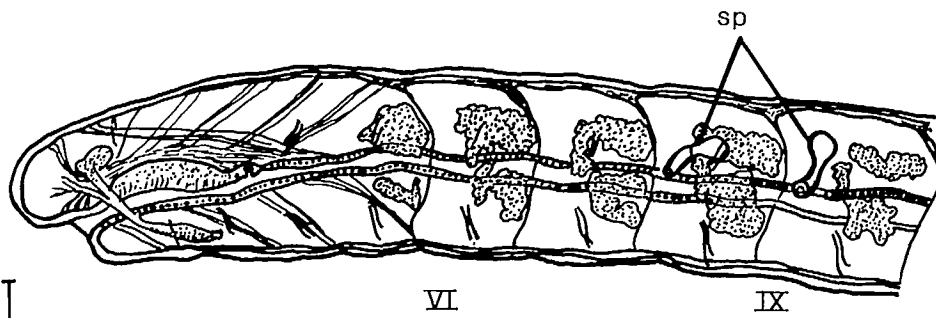

0.5

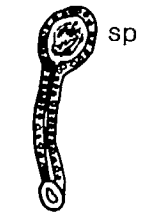
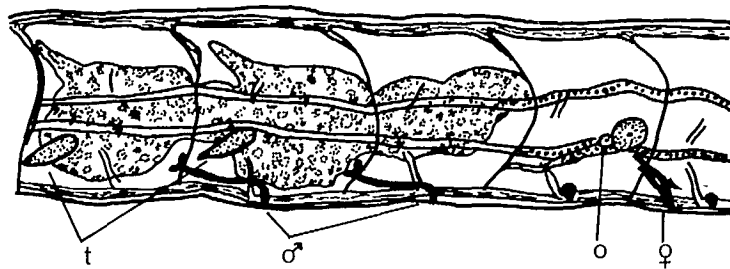

0.2

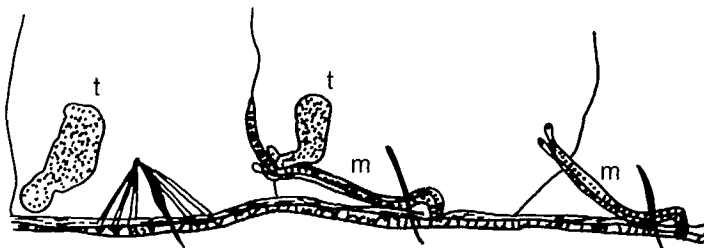

*H. brinkhursti*

## HAPLOTAXIS Hoffmeister, 1843

The family contains only a few genera at present, but this should be regarded as a temporary situation that will be resolved by a revision of the whole family. The family consists of a small number of primitive forms widely distributed around the world. Righi (1985) has transferred H. brinkhursti to Metataxis Righi, 1985, but this has not yet been fully evaluated.

### 1. H. gordioides (Hartmann, 1821)

This long thread-like worm may reach 200 to 400 mm in length, its general shape being reflected in the name. The ventral chaetae are large, solitary and sickle-shaped. The dorsal chaetae are small, solitary, and may be absent from a variable number of segments. There are testes in X and XI, male pores in XI and XII, and a pair of ovaries and female funnels in XII and XIII, female pores in XIII-XIV.

Fully mature forms have not been described from North America. H. ichthyophagus Gates, 1971, found in salmon redds in California, lacks dorsal chaetae on the posterior half of the body. It is probably synonymous with H. gordioides, as is H. forbesi Smith, 1918, from the Illinois River, in which the dorsal chaetae are present in a few anterior segments. The supposed gonads of that species were not recognized as such by Brinkhurst (1966). Also included here is H. emissarius (Forbes, 1890), also from Illinois, and H. gordioides of Altman (1936). Cook (1975) found specimens with dorsal chaetae on all segments.

Illinois, California, Virginia, West Virginia, Maryland, Tennessee, North Carolina, Ontario, mostly in ground waters. The North Carolina specimen had ingested a tubificid.

### 2. H. brinkhursti Cook, 1975.

25-30 mm. Chaetae simple-pointed, sigmoid, in four pairs on all segments except I and the last 3-5. Ventrals similar to dorsals or a little larger from II to between VIII to X, distinctly longer from X to XXV-XXXIV, and relatively very large from then to the posterior end. Spermathecal pores in the lateral line of VIII and XI. Testes in X and XI, ovaries in XIII.

West Virginia, in a cave.

The position of the ovary is unique for the family, and anticipates that of all of the earthworm families, making this an important oligochaete from an evolutionary theory perspective. It may prove necessary to classify it outside the family in a strictly Hennigian approach if the characteristic gonad sequence arose only once in oligochaete evolution, but this may be an instance of convergence. Righi (1985) has aligned the species with the genus Metataxis, and this will be reviewed with other members of the family elsewhere.



## OPISTOCYSTIDAE

This very small family was revised by Harman & Loden (1978), leaving one certain species and one species inquirenda on the North American list.

The species have a long proboscis in front and three ciliated appendages posteriorly.

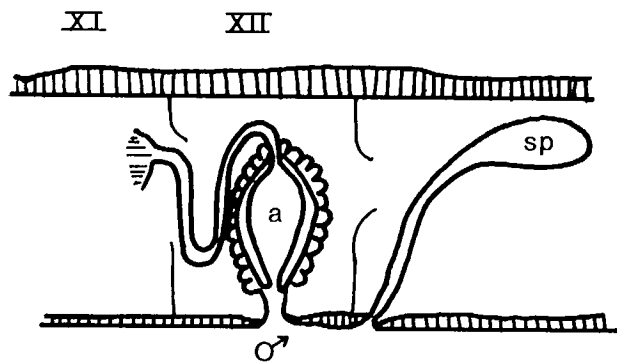
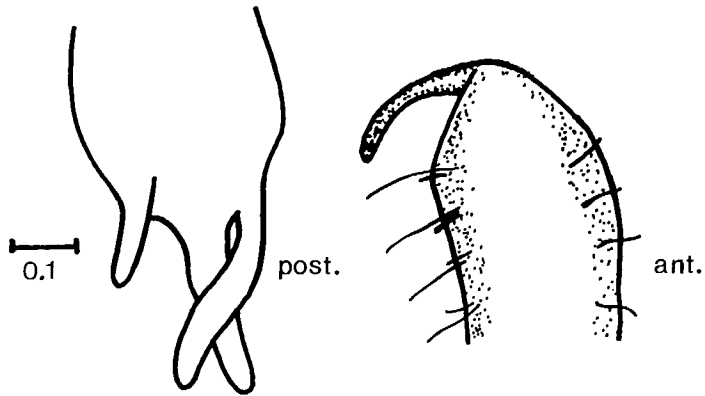
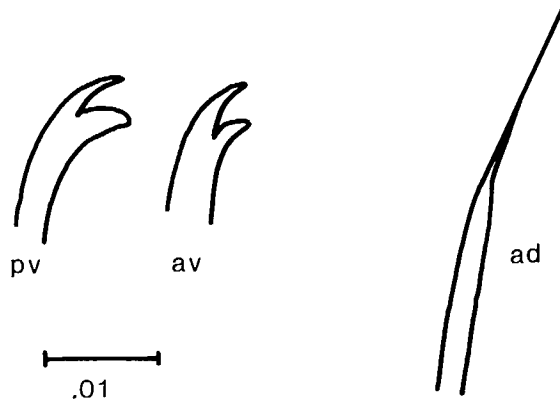

*Crustipellis tribranchiata*

OPISTOCYSTA Cernosvitov, 1936

1. O. flagellum (Leidy, 1880) sp. inq.

6-7 mm long, 30 segments. Approximately 3-6 dorsal chaetae and 4 ventral chaetae per bundle.

New Jersey, Pennsylvania.

The species is unidentifiable as described.

CRUSTIPELLIS Harman & Loden, 1978

1. C. tribranchiata (Harman, 1970)

1.7-2.9 mm, 15-30 segments. Proboscis to 180 um long. Three caudal appendages 300 um laterally, 90 um medially. Dorsal chaetae from II, 1-4 hairs, finely serrate, and 1-4 needles, simple pointed without nodulus. Ventral chaetae (3) 4 (5) per bundle, bifid with the upper teeth longer and thinner than the lower anteriorly, teeth about equal posteriorly. Testes in XI, ovaries in XII, atria in XII pear shaped with diffuse prostate, penes present. Spermathecae in XIII.

Louisiana, Mississippi, Florida, North Carolina.



## NAIDIDAE

The number of species in this family that may be found in North America is approximately 70, the uncertainty being due to some differences among biologists as to the significance of some of the taxonomic characters used. The possibility that bifid chaetae may acquire intermediate teeth, and that hair chaetae may acquire visible serrations or lateral hairs depending on the nature of the water in which they live, has caused revision of some species and left many more unresolved questions. Some of these features may be visible on many chaetae when they are examined by scanning electron microscopes, so it may be their degree of development rather than their presence or absence that is in question (Smith 1985).

Recent studies on Paranais and other genera suggests that the trend to dependence on immature specimens in taxonomic work should be revised. Mature specimens can often be found with a little persistence and it is becoming clear that chaetal characters alone may not be dependable. It is now acknowledged, for example, that giant chaetae in ventral bundles may be limited to older specimens and genital chaetae and reproductive organs may differ where somatic chaetae are identical.

Chaetal length is traditionally thought to be significant, but considerable size ranges are quoted in the various descriptions of the commonest species. This key will emphasize chaetal form rather than length. Difficulty with the distinction between certain species pairs in larger genera (Dero, Nais, Pristina, Pristinella) may be due to previously unrecognized intraspecific variability. Some large series of specimens needs to be carefully studied by someone with access to them.

Some genera (such as Pristina, Pristinella) seem under-represented as there are other widespread species not known from North America. Biologists in southern states might expect to see more South and Central American species - see Brinkhurst & Jamieson (1971), Brinkhurst & Wetzel (1984).



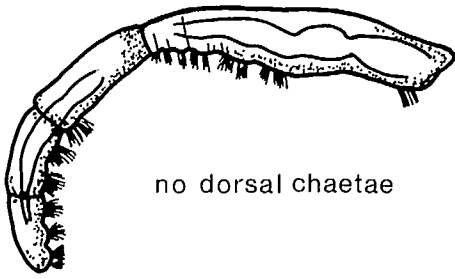

no dorsal chaetae

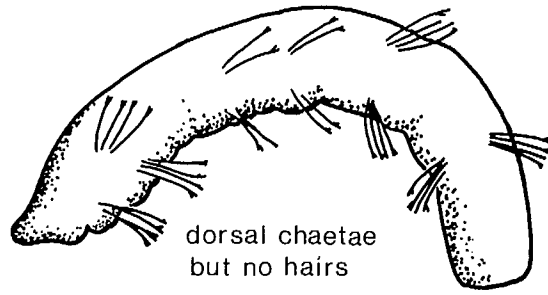

dorsal chaetae  
but no hairs

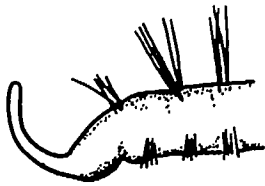

hair chaetae present  
with a proboscis

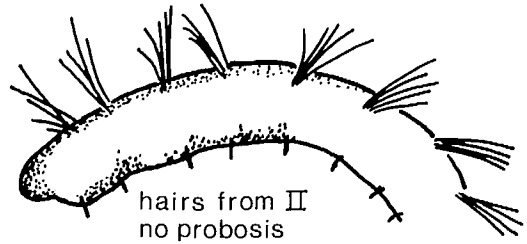

hairs from II  
no proboscis

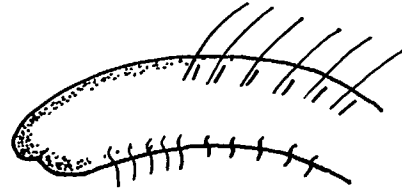

hairs from VI  
no proboscis

## NAIDIDAE

### Separation of Primary Groups

Dorsal chaetae may begin in II or III or even further back, even as far back as XVIII to XX.

- |  |                     |       |
|--|---------------------|-------|
| 1. No dorsal chaetae present*.   | <u>Chaetogaster</u> | p. 51 |
| 2. Dorsal chaetae present, dorsal bundles without hair chaetae.          | Group 1             | p. 43 |
| 3. Hair chaetae present in dorsal bundles, prostomium with proboscis+.   | Group 2             | p. 43 |
| 4. Hair chaetae present in dorsal bundles, prostomium without proboscis. | Group 3             | p. 45 |

\*Note: Specimens with dorsal chaetae from VI have been found. The enlarged pharynx, reduced prostomium, and absence of ventral chaetae from III to V are also diagnostic in this instance.

+Note: If the proboscis is broken off the torn surfaces can usually be detected. Careful observation is required to be certain of this character.

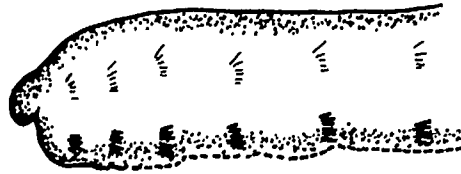

dorsal chaetae from II

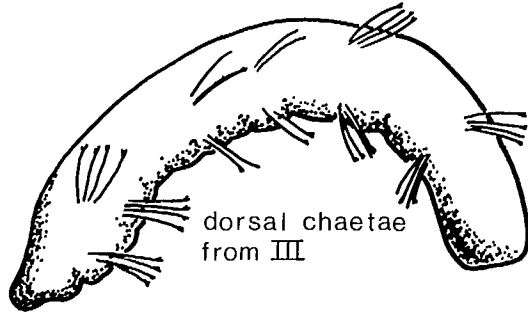

dorsal chaetae from III

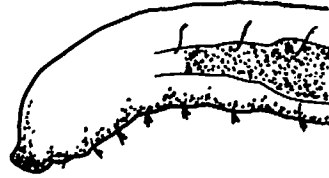

dorsal chaetae from VI

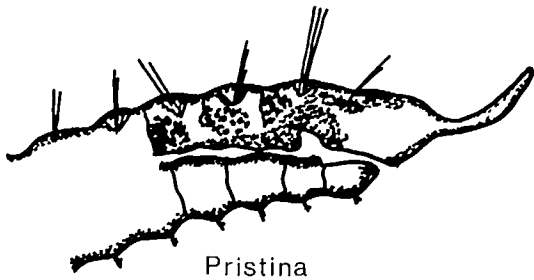

Pristina

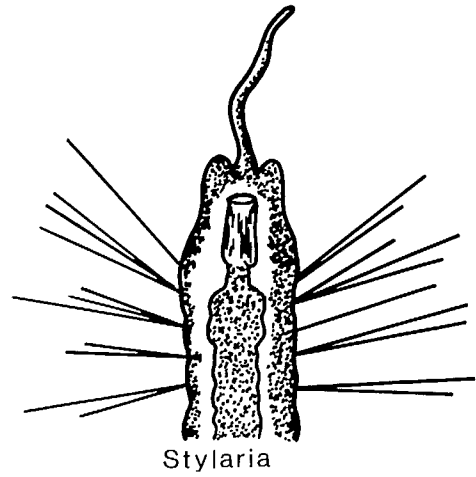

Stylaria

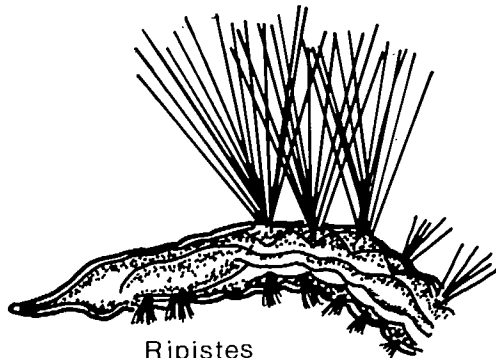

Ripistes

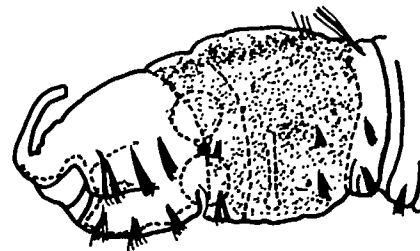

Arcteonais

NAIDIDAE

GROUP 1

1. Dorsal chaetae begin in II.	<u>Homochaeta</u>	p. 53
2. Dorsal chaetae begin in III.	<u>Amphichaeta</u>	p. 55
3. Dorsal chaetae begin in V.	<u>Paranais</u>	p. 57
4. Dorsal chaetae begin in VI*.	<u>Ophidonais,</u> <u>Uncinaiis</u>	p. 59
	<u>Piguetiella</u>	p. 61

\*According to Hiltunen & Klemm (1980) some Uncinaiis and Piguetiella specimens have dorsal chaetae in V also.

Rare specimens of Chaetogaster have dorsal chaetae from VI but they lack ventrals in III - V, have an enlarged pharynx and a reduced prostomium, and are still quite recognizable.

Group 2

1. Dorsal chaetae begin in II	<u>Pristina</u>	p. 65
2. Dorsal chaetae begin in VI (ventrals of IV - V may be missing)	<u>Ripistes</u> <u>Arcteonais</u> <u>Stylaria</u>	p. 71

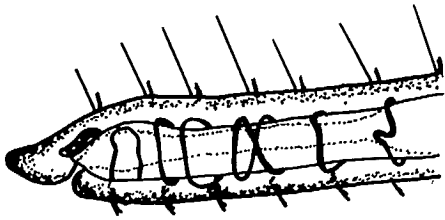

Pristinella

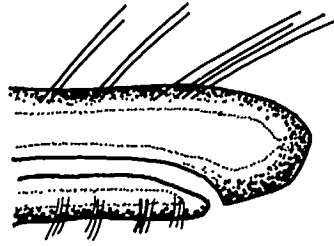

Bratislavia

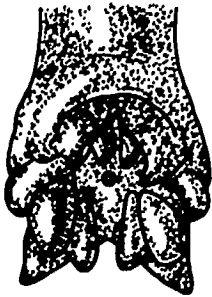

Dero (Dero)

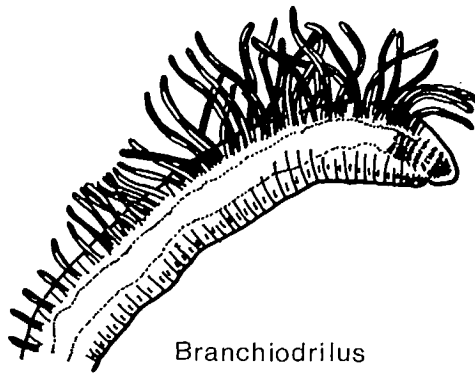

Branchiodrilus

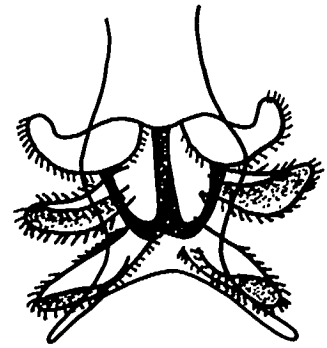

Dero (Aulophorus)



Dero (Dero)  
without gills

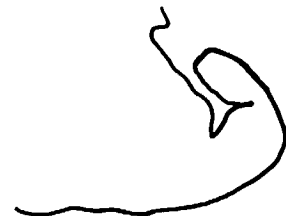

Dero (Allodero)

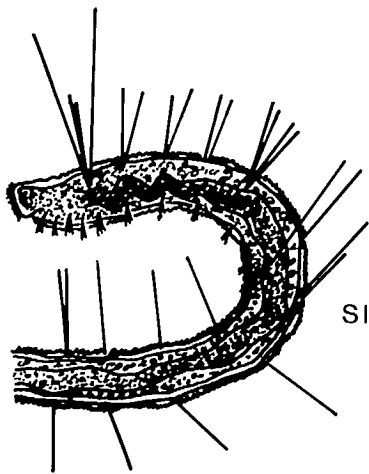

Slavina

NAIDIDAE

GROUP 3

This large group of genera will be subdivided to reduce the number of decisions to be made at each step.

- |  |   |       |
|--|---|-------|
| 1. Dorsal chaetae from II or III.  | <u>Pristinella</u><br><u>Stephensoniana</u><br><u>Bratislavia</u> | p. 99 |
| 2. Dorsal chaetae from IV-VI, posterior end of body with branchial fossa usually with gills (except parasitic phases in frogs and toads)[or gills along the body]. | <u>Dero</u><br><u>[Branchiodrilus*]</u>                           | p. 66 |
| 3. Dorsal chaetae begin between XVIII and XX in adults, shed anteriorly.   | <u>Haemonais</u>  | p. 73 |
| 4. Dorsal chaetae begin between V and VII (Note - ventrals of IV or IV-V may be missing).  | Group 4   | p. 47 |

\*Branchiodrilus is not yet reported from North America, but may be found eventually in the most southern states. The gills line the body. When posterior gills are broken off a Dero, it will key out as Nais, but the chaetae differ sufficiently to make detection of this error possible (see figures).



Vejdovskyella

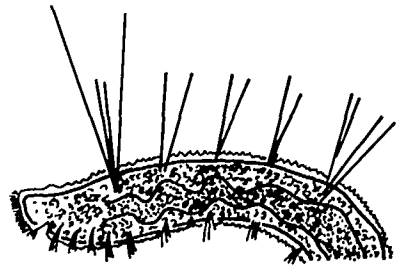

Slavina

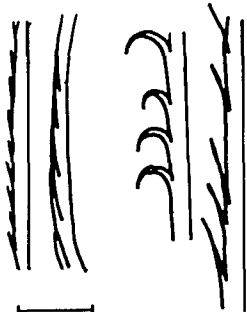

0.1  
serrate hairs



sabre shaped  
hair

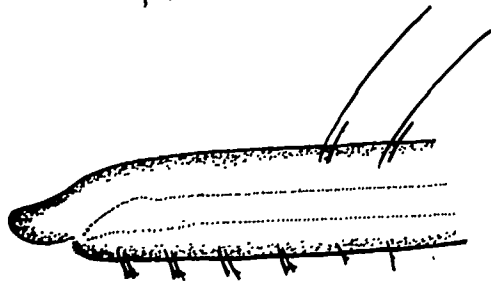

Group 5

NAIDIDAE

GROUP 4

1. Hair chaetae numerous, up to 9 per bundle, thick and sabre shaped with long lateral hairs, none especially elongate. Body wall with papillae and glands, with adhering foreign matter. Vejdovskyella p. 87
  
2. 1-3 especially elongate hair chaetae in each bundle of VI, otherwise 1-2 per bundle, shorter. Body wall papillate and glandular, with adhering foreign matter. Slavina p. 87
  
3. Hair chaetae short, occurring singly in some bundles, none elongate or with lateral hairs. Body wall naked. Piquetiella p. 61
  
4. Hair chaetae mostly 1-2 per bundle up to 5 in two species, none especially elongate or shortened, naked or with short lateral hairs. Body wall naked. Group 5 p. 49





Allonais needles



Specaria needles

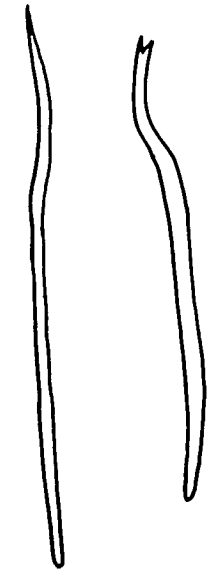

Nais needles



Nais

NAIDIDAE

GROUP 5

1. Needle chaetae of distinctive shape, with lateral teeth of unequal length, or obviously pectinate. Ventral chaetae change in form between V and VI, the differences between anterior and posterior chaetae are not great. Allonais p. 85
2. Needle chaetae bifid or faintly pectinate. Ventral chaetae do not change in form between V and VI, only those of II may differ from the rest. Specaria p. 61
3. Needle chaetae simple pointed or bifid. Ventral chaetae change in form between V and VI, the differences being considerable in most species, involving total length and width, relative sizes of the teeth, and nodulus position\*. Nais p. 89

\*The differences between the anterior and posterior ventral chaetae are not pronounced in N. communis and N. elinguis. The needles of the latter are distinctive, with only slight similarity to those of S. fraseri. Nais species are much commoner than Allonais or Specaria species in most situations. When in doubt try Nais.

Rare specimens of some Nais species have pectinate chaetae. Dero specimens lacking posterior ends may be keyed out to Nais, but the form of the chaetae should suffice to detect this error (compare figures).

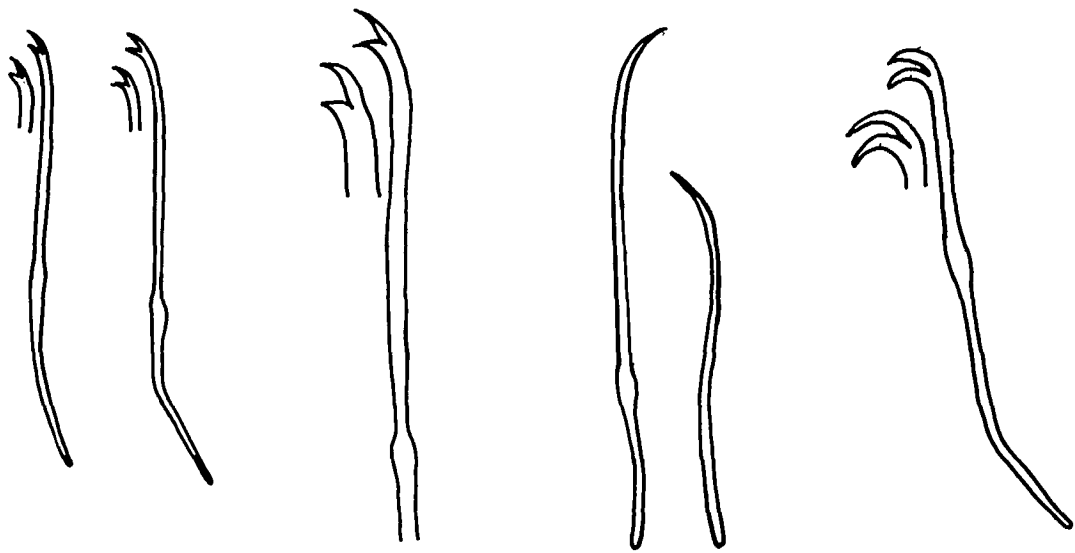

*C. diastrophus*

*C. diaphanus*

*C. setosus*

*C. limnaei*

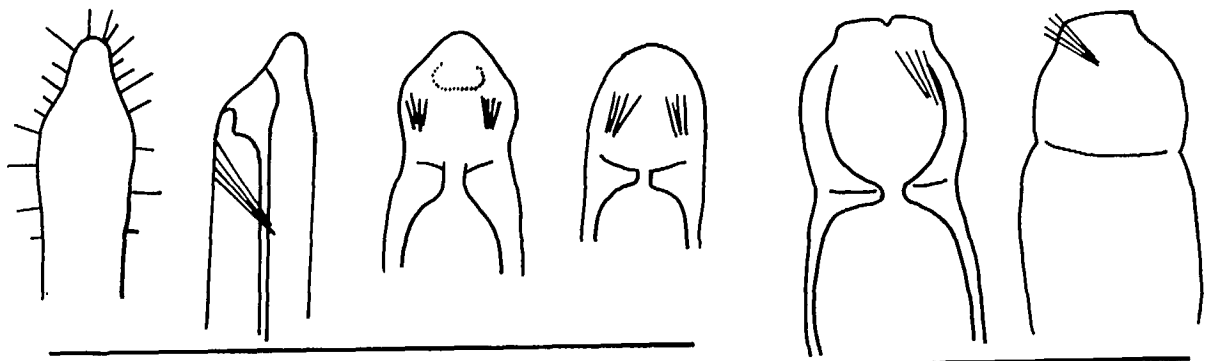

*C. diastrophus*

*C. diaphanus*

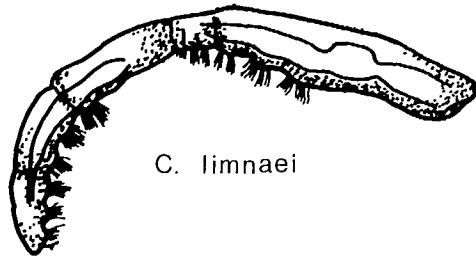

*C. limnaei*

CHAETOGASTER von Baer, 1827

There are four species listed here, but two or three others might be considered as noted below. Note that the ventral chaetae of III-V are missing, presumably associated with the highly modified pharynx. The author finds these species difficult to separate.

1. C. diastrophus (Gruithuisen, 1828)

Prostomium fairly well developed. Ventral chaetae of II 4-8 per bundle, those of VI onwards 3-7. Chaetae of II 72-110 um long. Some specimens bear dorsal chaetae from VI (Hiltunen & Klemm 1980, Brinkhurst & Kathman 1983). These were described by Lafont (1981) under the name Pseudochaetogaster longmeri.

The species also includes C. langi Bretscher, 1896 according to Hiltunen & Klemm (1980). This species was traditionally supposed to be separated from C. diastrophus by the less conspicuous prostomium and the different size range (63-100 um) of the chaetae of II.

Widespread.

2. C. diaphanus (Gruithuisen, 1828)

Prostomium inconspicuous. Ventral chaetae of II 6-13 per bundle, 4-10 from VI onwards. Chaetae of II more than 145 um long, up to 350 um. This species is said to include C. cristallinus Vejdovsky, 1883, which has a median prostomial incision and supposedly smaller chaetae (those of II from 111-165 um).

Widespread.

3. C. setosus Svetlov, 1925

Prostomium reduced. Ventral chaetae simple-pointed, 9-10 per bundle in II, 5-8 from VI onwards.

St. Lawrence and Hudson River drainages.

4. C. limnaei von Baer, 1827

Prostomium vestigial, ventral chaetae up to 20 per bundle with strongly curved teeth. Parasitic or commensal on molluscs.

Widespread.



HOMOCHAETA Bretscher, 1896

1. H. naidina Bretscher, 1896

The supposedly single American species in this genus is the only naidid with dorsal chaetae beginning in II, but no hair chaetae. However, Hiltunen & Klemm (1980) indicate that no voucher specimens support the single record from Virginia.

The 5-6 dorsal chaetae per bundle of II-V are longer and thinner than the rest with the upper teeth longer than the lower. The other bundles all bear 3-5 chaetae with teeth of equal length. These characteristics, plus the small size (8 mm), should allow the species to be distinguished from immature Limnodrilus (Tubificidae). There are no available illustrations.

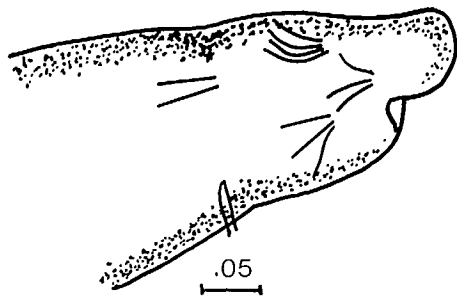

A. leydigi

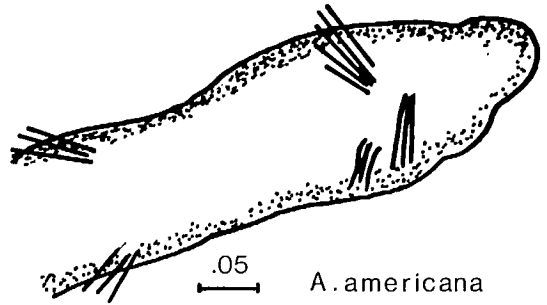

A. americana

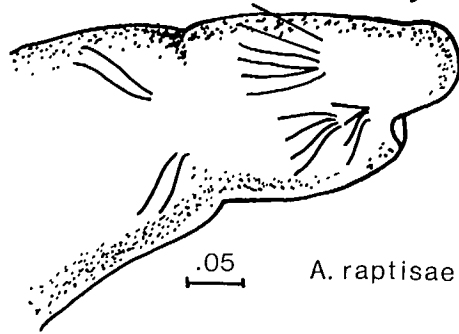

A. raptisae

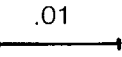
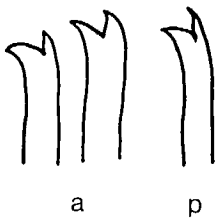

A. leydigi

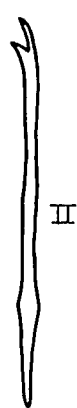

A. americana

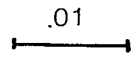
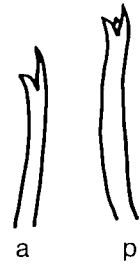

A. raptisae

AMPHICHAETA Tauber, 1879

This genus is composed of species with an elongate pharynx, as in Chaetogaster, but the prostomium is well developed. Microscope preparations in lactophenol, in which internal organs may only be visible on newly made slides, show the elongate pharynx as a gap between the chaetae of segments III and IV. Hence, there are three closely grouped chaetal bundles (the dorsal of III, the ventrals of II and III) in front of the gap, and smaller gaps between all of the chaetal bundles behind IV. This gap between II and IV is very noticeable in A. americana.

The three American species can be distinguished as follows:

1. A. leydigi Tauber, 1879

Usually 5 chaetae in the dorsal bundles of III, fewer elsewhere; anteriorly the upper chaetal teeth are a little shorter and thinner than the lower, posteriorly they become straighter and as long as or longer than the lower.

Widespread, freshwater.

2. A. americana Chen, 1944

Up to 7 chaetae in dorsal bundles in III, the upper teeth slightly longer than the lower anteriorly, reaching three times the length of the lower tooth posteriorly.

North and South Carolina, Michigan, New Jersey, freshwater.

3. A. raptisae (Chapman, 1981)

Dorsal chaetae of III 5 per bundle, the others fewer. Anterior chaetae with upper teeth projecting straight in line with the shaft, teeth short but equally long, but the upper tooth becomes a little longer posteriorly; some chaetae with a single intermediate tooth only visible under the best oil immersion lenses.

Fraser River (Vancouver, British Columbia), brackish water.

The common European estuarine form A. sannio Kallstenius, 1892, has not been reported from North America. The distinction between it and A. leydigi is not great, perhaps due to confusion of the two in earlier accounts (Brinkhurst & Kathman 1983). The two could possibly be synonymous.



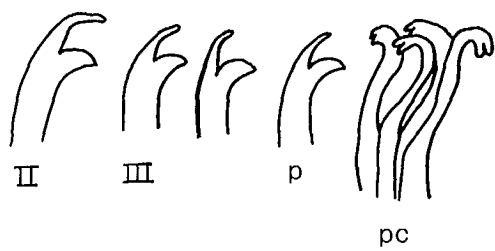

*P. litoralis*

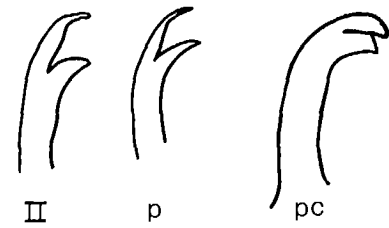

*P. frici*

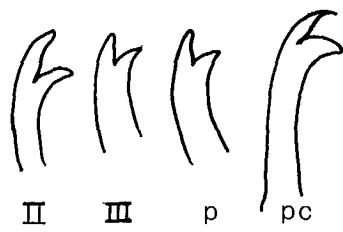

*P. birsteini*

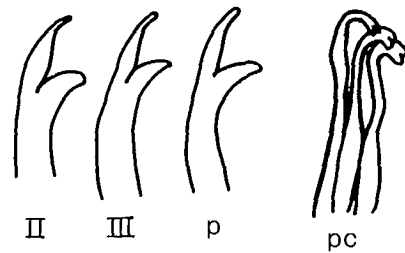

*P. grandis*

PARANAIS Czerniavsky, 1880

There are four species in this genus according to Brinkhurst & Coates (1985) but only two are widely distributed.

1. P. litoralis (Muller, 1784)

Chaetae of II 4-7 per bundle, slightly longer than the other bundles, and with the upper teeth longer than the lower. All other chaetae usually 3 per bundle with approximately equal teeth, but the ventral chaetae of V replaced by strongly modified penial chaetae with short, thin strongly curved distal ends. Atria 2 to 3 times longer than broad, thick muscular walls. Body wall with some foreign material.

Widespread, mostly coastal in tidal fresh or brackish water.

2. P. frici Hrabe, 1941 (= Wapsa mobilis Liang, of Hiltunen & Klemm 1980).

Chaetae of II 2-4 per bundle, those of all other bundles except V only 1-2, rarely 3 per bundle, all with the upper teeth much longer than the lower. Penial chaetae in V 2-3 per bundle, sigmoid and bifid but thicker than other chaetae, and hence only slightly modified. Atria globular with thin walls and little sign of a muscular layer. Body wall with transverse furrows and a thin layer of foreign matter.

Widespread, often coastal but usually in freshwater, sometimes in brackish water.

3. P. birsteini Sokolskya, 1971

Ventral chaetae of II 5-7 per bundle, with upper teeth twice the length of the lower. Ventral chaetae 4-5 per bundle in II/IV with upper teeth longer than the lower, posteriorly all chaetae 2-4 per bundle with teeth about equal. Penial chaetae in V paired, curved, bifid, with short distal ends. Atrial ampullae 1.5 times longer than broad, with thick muscular walls. Body wall distinctly papillate, with transverse ridges and foreign matter in the grooves.

Pacific coast, British Columbia, Washington, coastal.

4. P. grandis (Harman, 1977)

Ventral chaetae of II 6-7 per bundle, clearly longer than other chaetae; all other bundles except those of V with 3 chaetae sometimes 2 dorsally, all with very long upper teeth. Penial chaetae 4 per bundle strongly modified with short, thin strongly hooked distal ends. Atrial ampullae globular with thin walls. Foreign matter on the body wall.

Louisiana, Texas, coastal.



d

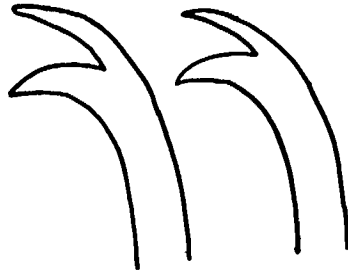

av

pv

*O. serpentina*

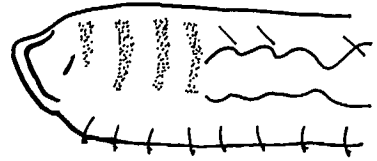

d

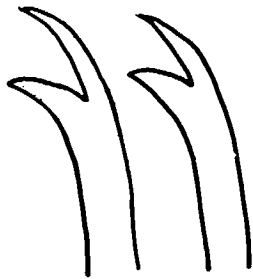

II v

VII v



pv

d

*U. uncinata*

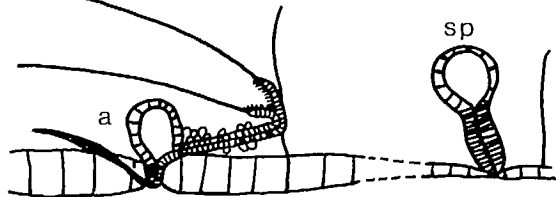
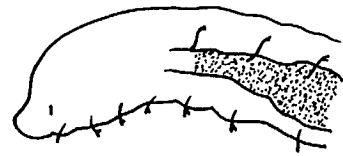

sp

a

OPHIDONAIS Gervais, 1838; UNCINAIS Levinson, 1884

There is a single American species in each of these genera, and they are very readily separable.

1. O. serpentina (Muller, 1773)

Scattered papillae on the body wall and a covering of foreign matter, and 3-4 transverse pigment stripes anteriorly. There are 2-6 chaetae in ventral bundles, with those of II longer than the rest. Dorsal chaetae solitary, stout, straight needles with faintly bifid or bluntly simple pointed tips.

Widespread.

2. U. uncinata (Orsted, 1842)

This species has been reported to inhabit sediment, protruding its anterior end into the water. The dorsal anterior end bears a series of brown pigment bands. There are 2-4 chaetae per bundle dorsally, all slightly shorter than the ventrals. The ventral chaetae number 2-7 per bundle, those of II being longer than the rest\*.

Widespread.

\* Specimens of Piguetiella michiganensis could be erroneously identified as U. uncinata, but the upper teeth of all the anterior chaetae of the latter are longer than the lower, whereas those of P. michiganensis are not.

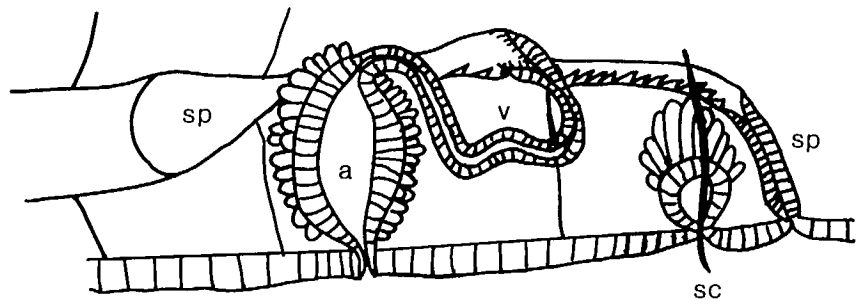
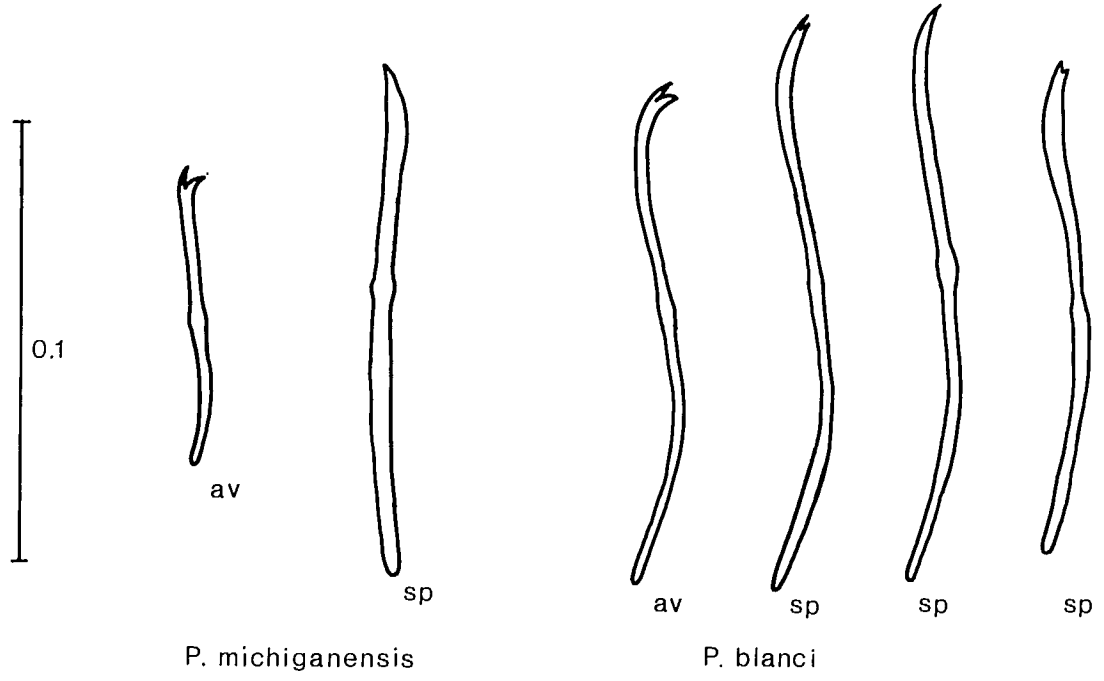

*P. blanci*

PIGUETIELLA Sperber, 1939; SPECARIA Sperber, 1939

There are five species in this group, two in Piguetiella and three in Specaria. However, the two Piguetiella species may be synonymous. The genera are distinguished as follows:

- |   |                    |       |
|---|--------------------|-------|
| 1. Hair chaetae absent, or a single short hair chaeta in some dorsal bundles. | <u>Piguetiella</u> | below |
| 2. Hair chaetae 2 or more per dorsal bundle.                                  | <u>Specaria</u>    | p. 63 |

In mature specimens the spermathecal chaetae may be seen replacing the ventral bundles of V in Piguetiella, whereas the genital chaetae of mature Specaria are penial.

There are two species of Piguetiella, though it is possible that the second is a synonym of the first. The first was reported in North America by Strayer (1983). Experimental work on other species shows that variation of simple factors such as pH affects the presence or absence of hair chaetae.

1. P. blanci (Piguet, 1906)

Worms mostly eyeless. Dorsal chaetae 2-6 bifid needles, 0-3 hairs, the hairs may be scarce or even totally absent. Ventral chaetae mostly 5-8 but up to 10 per bundle, closely resembling the needles. Spermathecal chaetae in V.

New Hampshire.

This species may have been confused with Specaria josinae in earlier studies. That species has 2-6 longer hair chaetae (more than 1.7 times the needles in length).

2. P. michiganensis Hiltunen, 1967

Eyeless worms with no hair chaetae but otherwise resembling P. blanci, this may be no more than a synonym of the above. In Europe P. blanci is said to lack hair chaetae at times. Specimens of this species with hair chaetae may possibly have been identified as S. josinae.

North Central North America, and as far south as Virginia.

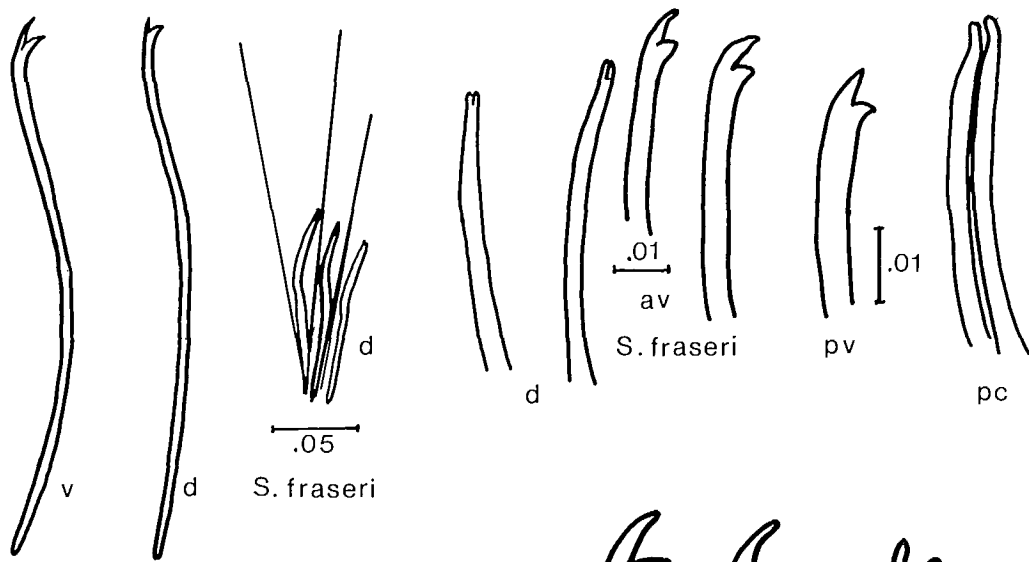

*S. josinae*

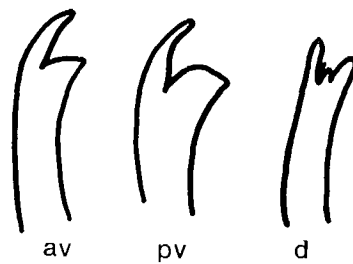

*S. hellei*

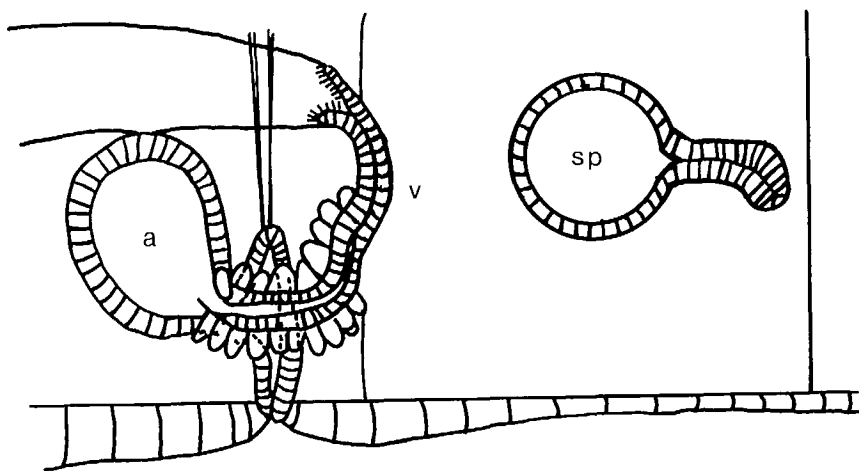

*S. josinae*

Piguetiella, Specaria (continued)

There are three species of Specaria:

1. S. josinae (Vejdovsky, 1883)

Until recently this was the sole species in the genus. There are 2-6 hair chaetae and 2-6 curved bifid needles in dorsal bundles, with teeth of equal length. There are 5-10 chaetae in ventral bundles with the upper teeth longer than the lower\*.

Widespread.

2. S. fraseri Brinkhurst, 1978

This species has up to 3 hair chaetae and 3 bifid needles per bundle, with teeth of equal but varying length that are closely parallel to each other. The ventral chaetae of II are longer and thicker than the rest with the thin upper teeth up to twice as long as the lower. In other ventral bundles there are 2-4 chaetae with the upper tooth equal to or 1.5 times the length of the lower.

Vancouver, British Columbia.

3. S. hellei (Brinkhurst, 1971)

This species was attributed to this genus by Brinkhurst & Kathman (1983) despite the serrate nature of the two long hair chaetae. There are in addition one shorter hair chaeta and 1-3 needle chaetae in each dorsal bundle. The needles vary from bifid to pectinate with fine intermediate teeth visible under oil immersion lenses. The ventral bundles contain 4-6 chaetae with upper teeth longer than the lower, those of II being longer than the rest.

Coastal Alaska, British Columbia.

\* The hair chaetae in S. josinae are  $> 1.7$  times the length of the needles, whereas in the similar P. blanci they are  $< 1.7$  times the length of the needles.





needle bifid  
short teeth



needle bifid  
long teeth

PRISTINA Ehrenberg, 1828 emm. Brinkhurst, 1984

The six species named here can be divided into two groups:

- |  |         |       |
|--|---------|-------|
| 1. Needle chaetae simple pointed*<br>or bifid with short teeth | Group A | p. 67 |
| 2. Needle chaetae bifid with long<br>teeth                     | Group B | p. 69 |

\* Specimens with a proboscis, simple pointed needles, but three projections at the posterior end of the body are opisthocystids (page 35).

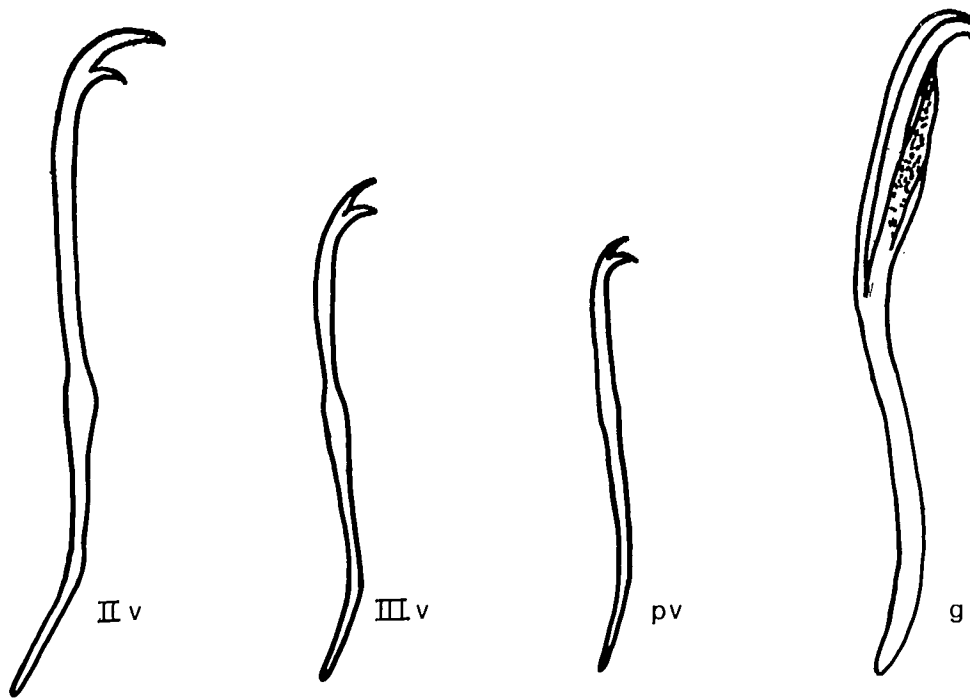

*P. leidyi*

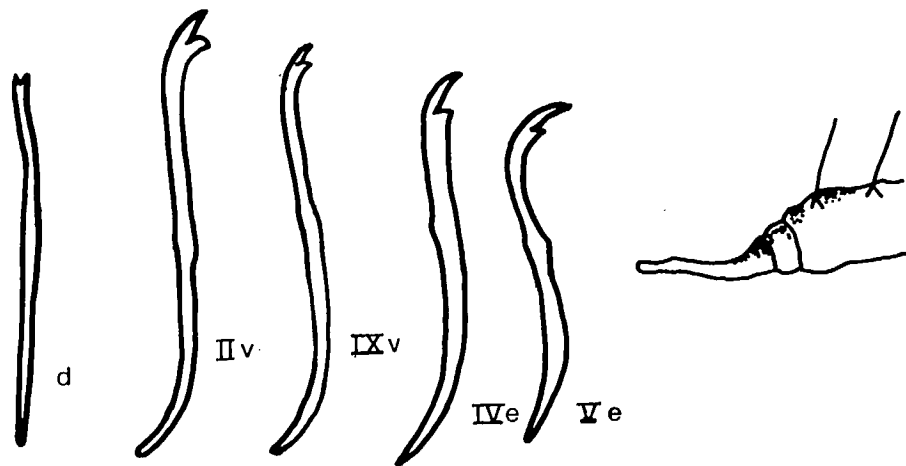

*P. aquiseta*



Pristina (continued)

(A) P. leidyi has elongate hair chaetae in III, and simple pointed needles, whereas P. aequiseta has no elongate hairs, and has bifid needles. P. proboscidea has simple pointed needles but no elongate hairs; it may be present in N. America.

1. P. leidyi Smith, 1896

Hair chaetae 1-4 per bundle, serrate except in II-III, extremely elongate in III, needles 1-4, minutely bifid. Ventral chaetae 2-10 per bundle, or even 12 posteriorly, those of II with upper teeth 1.5-2 times as long as the lower, the rest with teeth equally long; genital chaetae in VI, 1-3 per bundle, bifid with long converging teeth, chaetae set in glands.

Widespread.

Harman & McMahan (1975) and Harman (1982) found that close examination of all their American material of the P. longiseta complex had bifid needles, though these are often difficult to detect. Simple pointed needles are reported from the European forms which these authors now refer to P. longiseta, the American forms being identified as P. leidyi. Hiltunen & Klemm (1980) acknowledge that most specimens are of the leidyi form, but claim to have the longiseta form in Michigan. They prefer to retain previous nomenclature with refers these two forms to P. longiseta as subspecies.

2. P. aequiseta Bourne, 1891

Dorsal chaetae 1-2 finely serrate hairs, 1-2 minutely bifid needles. Most ventral chaetae 5-8 per bundle, those of II longer and thinner than the others, with the upper tooth twice the length of the lower; those of III-VII have upper teeth slightly shorter than the lower, those behind VII more curved, thicker and with equally long teeth. Very thick enlarged chaetae replace those of IV, V and/or VI in many instances. Genital chaetae in VI or VI and VII. P. foreli Piguët, 1906 and P. evelinae Marcus, 1943 are included in this species by Loden & Harman (1980) and Harman (1982) who showed that the giant chaetae appear in older specimens (they are supposedly absent in P. foreli).

Widespread.

3. P. proboscidea Beddard, 1896

This species has simple pointed needles but no elongate hair chaetae. It is included in a regional key to the fauna of the Carolinas but no published record is known.

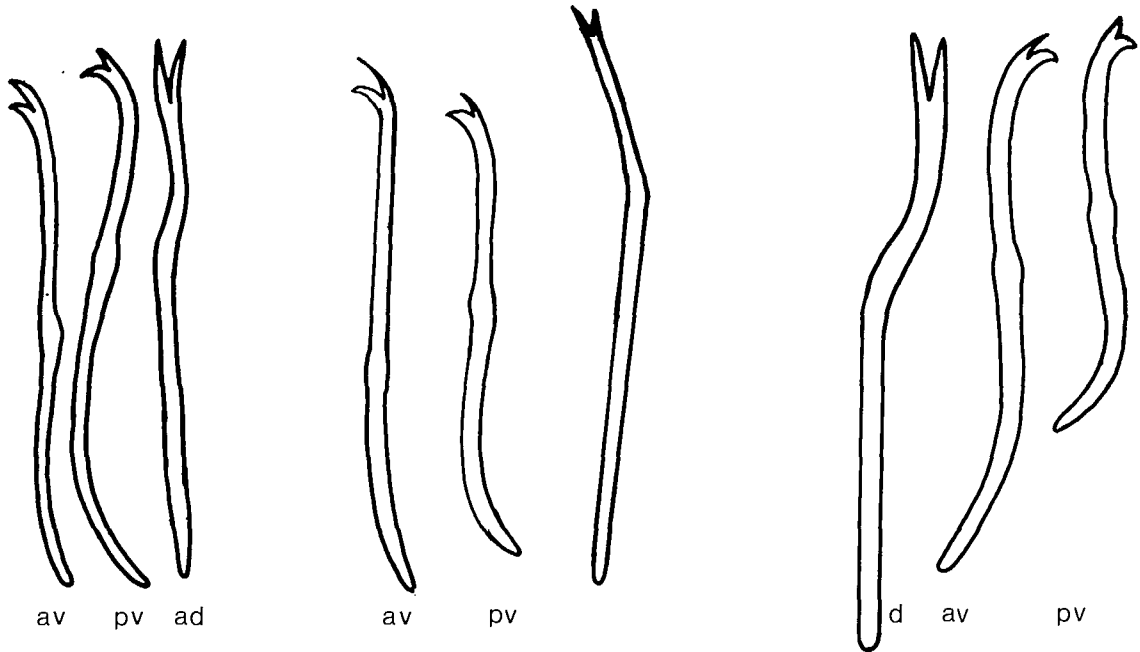

*P. breviseta*

*P. americana*

*P. synclites*



*P. breviseta*

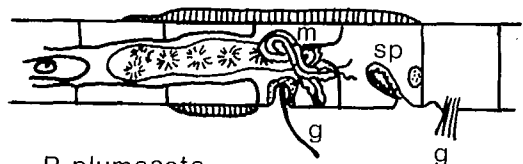

*P. plumaseta*



*P. americana*

Pristina (continued)

(B) The following species differ in the form of the needles and the serration of the hair chaetae.

1. P. breviseta Bourne, 1891

Hair chaetae non-serrate, single; single needles with long equal teeth. Ventral chaetae of II with upper teeth longer than the lower, the posterior ventrals with teeth equally long to upper shorter. Genital chaetae one or two on the right side of VII or on the right of VII and left in VIII, very large and set in glands.

Widespread

2. P. plumaseta Turner, 1935

Hair chaetae 1-2 per bundle, serrate; needles 1-2 per bundle, bifid, with the upper teeth slightly longer and thinner than the lower. Ventral chaetae 4-8 per bundle, teeth subequal. Genital chaetae in VI and VIII, more than twice the length of the rest, simple-pointed with knob-like tips, 4 per bundle in VI (no figures are available).

Ontario, Georgia, Virginia, Mississippi.

3. P. synclites Stephenson, 1925

Hair chaetae 1-2 per bundle non-serrate; needles 1-2 per bundle, bifid with long teeth, the upper shorter than the lower. Ventral chaetae 4 per bundle, fewer posteriorly, with teeth equally long. No genital chaetae reported.

East of the Mississippi, Arkansas.

4. P. americana Cernosvitov, 1937

Hair chaetae 1-2 per bundle, serrate; needles 1-2 per bundle, bifid, with the upper tooth shorter and thinner than the lower. Ventral chaetae 3-6 per bundle anteriorly, 1-2 posteriorly, in II the upper tooth is longer than the lower, the nodulus is proximal, in III the teeth are about equal, the nodulus median, in the rest the upper tooth is shorter and the nodulus is distal.

Texas.

If there are problems identifying species, note the possible confusion of the proboscis character, and try Pristinella (page 103), especially for P. breviseta.

.01

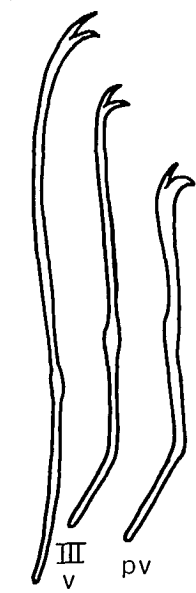

II v

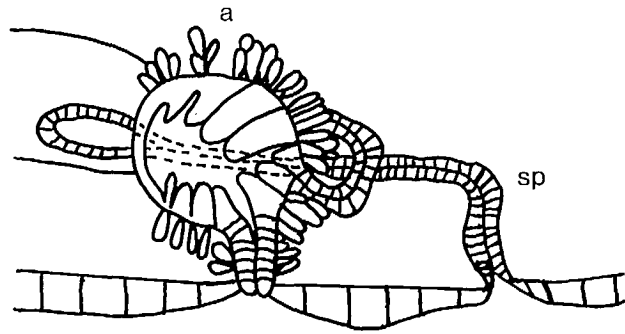

*R. parasita*

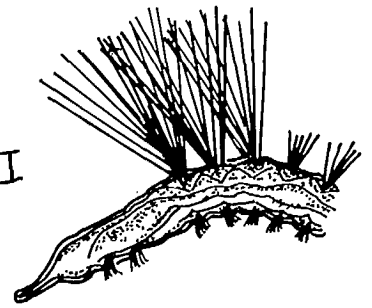

*S. lacustris*

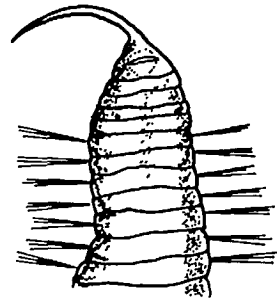

*S. fossularis*

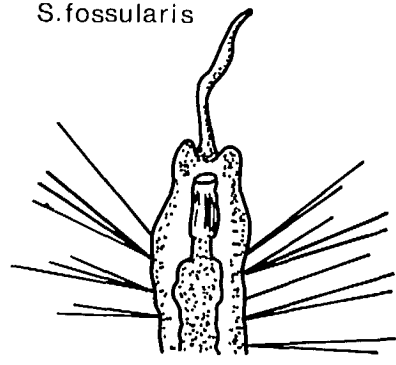

*S. lacustris*



av

.01



av pv

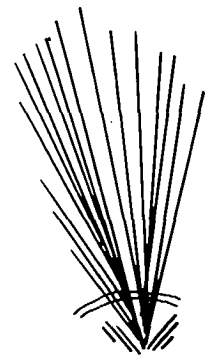

d

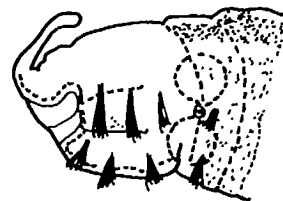

*A. lomondi*

RIPISTES Dujardin 1842; ARCTEONAIIS Piguët, 1928;  
STYLARIA Lamarck, 1816

These three genera are monotypic and the species are readily recognizable.

1. R. parasita (Schmidt, 1874)

The dorsal chaetal bundles of VI-VIII contain 2-16 giant hair chaetae, 2-6 short hair chaetae, and 10-18 straight simple pointed needles which lack a nodulus. There are 2-7 ventral chaetae in II and III with a proximal nodulus and upper teeth longer than the lower. The ventral chaetae are absent on IV-V, but in the rest there are 3-8 thicker chaetae with a slightly distal nodulus and upper teeth shorter than the lower. Simpson & Abele (1984) and Barton & Griffiths (1984) confirmed the presence of the species in North America.

New York State, Ontario.

2. S. lacustris (Linnaeus, 1767)

The proboscis in this species may arise from the prostomium or between the folds of an invaginated lobe. There are 1-3 hair chaetae and 3-4 simple-pointed needles that lack a nodulus in the dorsal bundles. The ventral chaetae are all alike, are 4-14 per bundle, and have a characteristic double proximal bend in contrast to the usual straight to gently curved proximal end.

Widespread.

As in many of the oldest descriptions there is a long list of synonyms of this species. S. fossularis Leidy, 1852 was separated from S. lacustris by the invaginated lobe on the prostomium bearing the proboscis. It was synonymized with S. lacustris as early as 1900. DiPersia (1975) demonstrated that the proboscis characteristic could change in cultures. If other characteristic differences can be found the separation of species might be validated.

3. A. lomondi (Martin, 1907)

The 8-18 straight slender hair chaetae and 9-12 fine straight needles without a nodulus do not vary in length regionally as do those of R. parasita. The ventral chaetal bundles contain 3-7 slightly curved chaetae with the upper teeth longer and slightly thinner than the lower. Many American specimens seem to lack the large number of chaetae quoted as characteristic, but they are otherwise clearly identifiable.

Widespread.



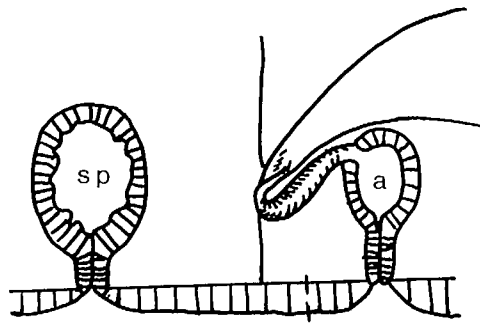
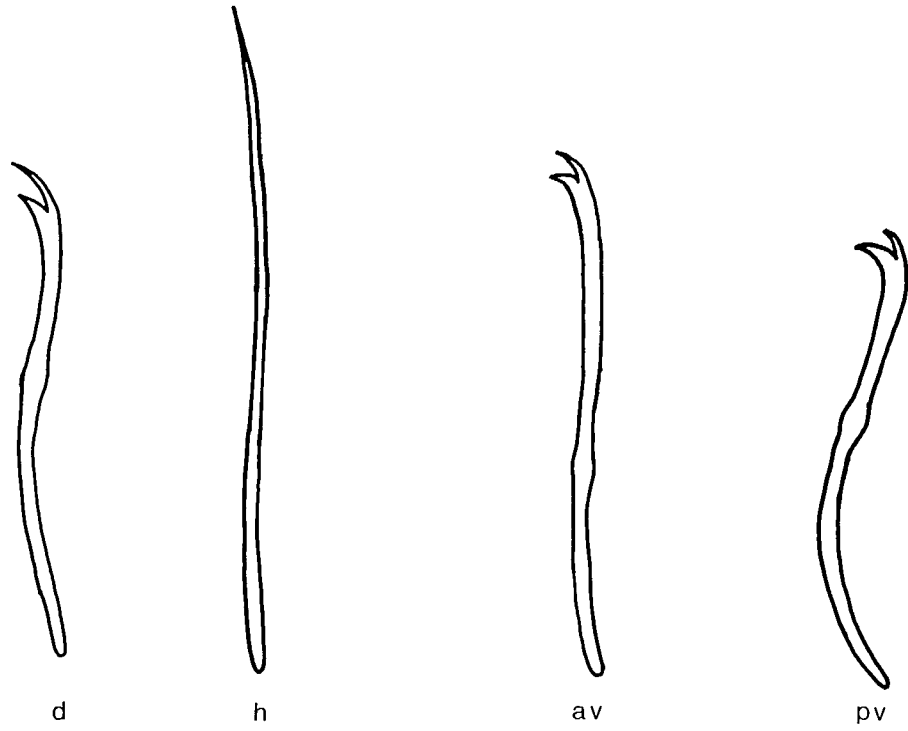

*H. waldvogeli*

HAEMONAIS Bretscher, 1900

1. H. waldvogeli Bretscher, 1900

The single species in this genus is characterised by the absence of dorsal chaetae in segments II-XVIII or XX, though they do arise anteriorly (in II or VI has not been established) and are subsequently shed. There is a single short hair and a curved needle with distal nodulus, and teeth that are long with the upper longer than the lower. The ventral chaetae of the first 15-17 segments are slightly longer and thinner than the rest, with a proximal nodulus, the others are more strongly curved, with a distal nodulus, and the upper teeth shorter and thinner than the lower.

Widespread east of a line from Wisconsin to Texas.

The dorsal chaetae begin in II in some specimens from North Carolina (D. Lenat collection). The hairs are missing from some segments, and all the needles are simple pointed. This was mentioned by Sperber (1948) as a variant of this species.

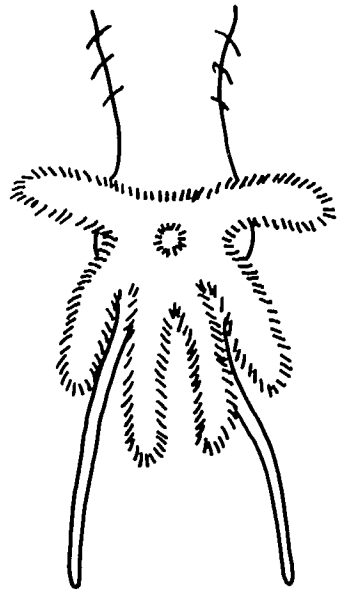

gills and palps

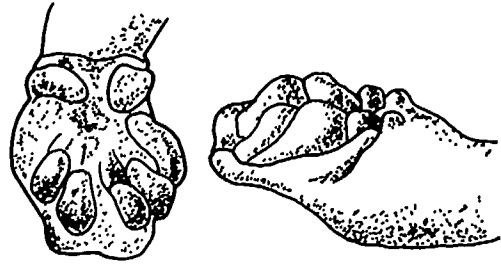

gills usually present

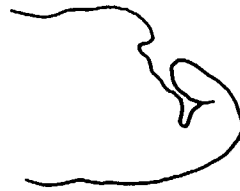

branchial fossa rudimentary  
or absent

DERO Oken, 1815

There are three subgenera in this large genus, divisible by the nature of their posterior ends:

- |   |                                   |       |
|---|-----------------------------------|-------|
| 1. Branchial fossa with both gills<br>and elongate ciliated palps,<br>free living.      | <u>Dero</u> ( <u>Aulophorus</u> ) | p. 83 |
| 2. Branchial fossa usually with gills<br>but never with ciliated palps,<br>free living. | <u>Dero</u> ( <u>Dero</u> )       | p. 79 |
| 3. Branchial fossa rudimentary or<br>absent, parasites of frogs<br>and toads.           | <u>Dero</u> ( <u>Allodero</u> )   | p. 77 |

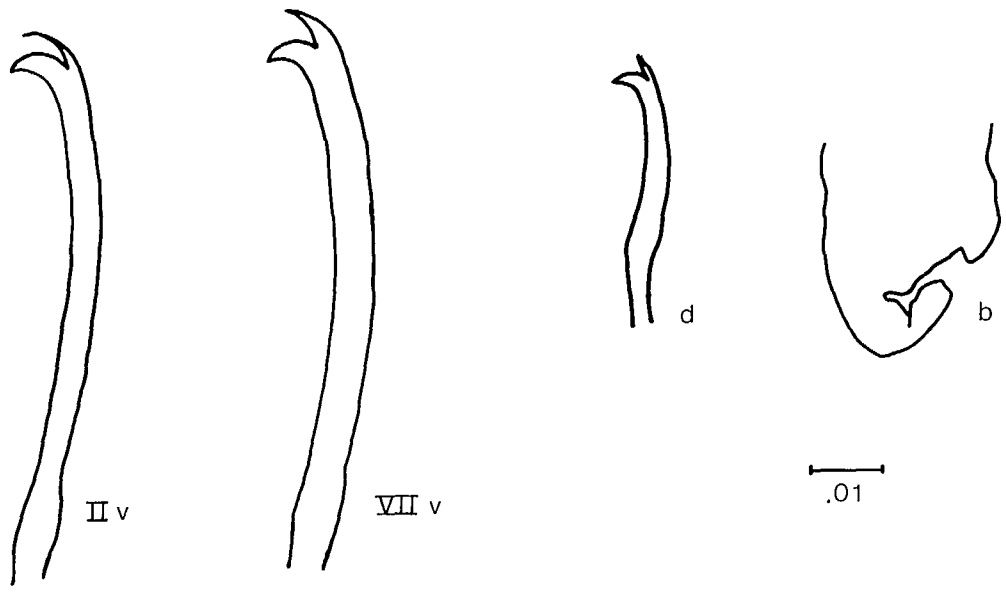

*D. hylae*

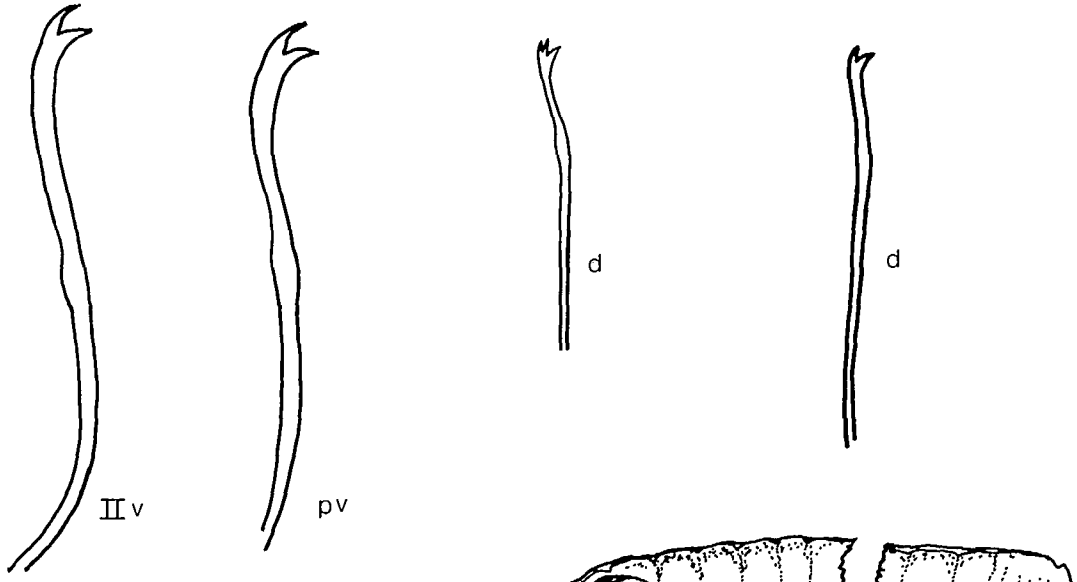

*D. floridana*

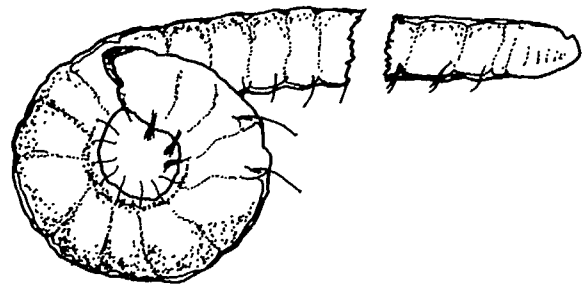

DERO (ALLODERO) Sperber, 1948

There are two North American species in this subgenus of parasitic forms, D. (A.) hylae and D. (A.) floridana. They are only known from the ureters of frogs and toads respectively, the free living forms are unknown.

1. D. hylae Goodchild, 1951

This species has few dorsal chaetae. When present the hair chaetae are thin, delicate and singular. The occasional needles are 1 or 2 per bundle, bifid with the upper teeth shorter than the lower. The anterior ventral chaetae are usually 4-6, rarely 8 per bundle, with teeth more or less equally long but the upper thinner, becoming shorter posteriorly. A rudimentary branchial fossa is present but lacks gills.

Mississippi, Florida, Louisiana; in frogs.

2. D. floridana Harman, 1971

There are solitary hairs and needles in this species, the needle teeth are equally long, sometimes with a single intermediate tooth. There are 3-4 ventral chaetae with approximately equal teeth.

Florida; in toads.

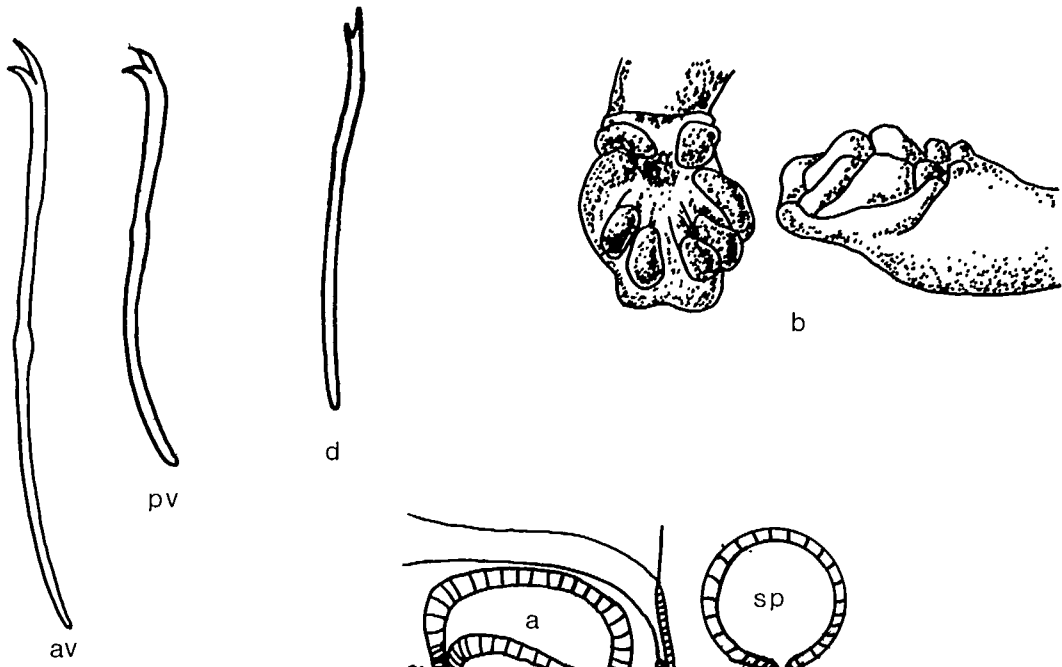

*D. digitata*

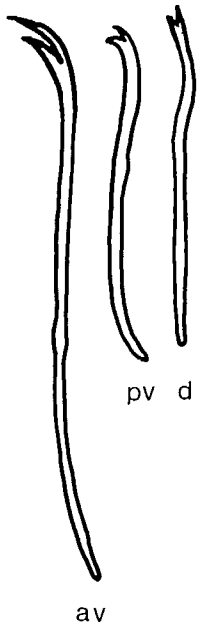
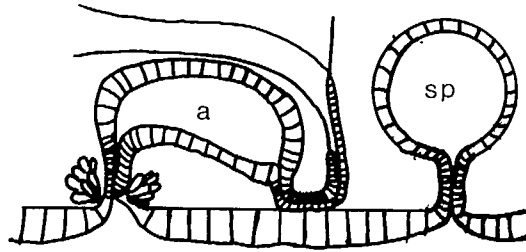

*D. obtusa*



*D. nivea*

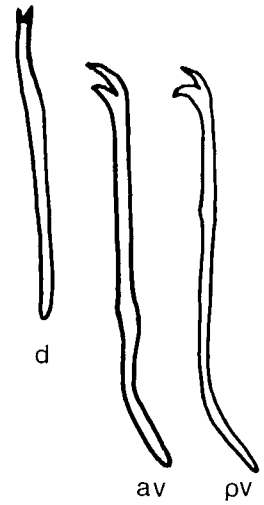

DERO (DERO) Oken, 1815

These six species have gills in a branchial fossa posteriorly (or just a branchial fossa - D. abranchiata) but no elongate palps as seen in Dero (Aulophorus) species.

Dero species with the posterior ends missing may be initially keyed out as Nais, but with practice the chaetal differences usually resolve the problem. Gills are best seen in live worms or in fluid prior to mounting on slides.

There are two groups of species:

- |  |         |       |
|--|---------|-------|
| 1. Those with gills in the fossa and bifid needles.                        | Group A | below |
| 2. those with no gills in the fossa, or with trifid or pectinate needles . | Group B | p. 81 |

(A) The needle teeth are unequal in D. digitata, equal in the other two. D. nivea has a spout-like prolongation of the fossa, not seen in D. obtusa. Other detailed differences are as follows:

1. D. digitata (Muller, 1773)

Needles and hairs single in each bundle, the needles with upper teeth 1-2 times the length of the lower. Ventral chaetae of II-V 3-6 per bundle, upper tooth 1.2-2 times the lower; the rest with teeth equally long or the upper slightly the longer, 2-5 per bundle. Gills usually number 4 pairs but variable.

Widespread.

2. D. obtusa d'Udekem, 1885

Hairs and needles usually single, may be paired, needles minutely bifid. Anterior ventral chaetae 2-4 per bundle with upper teeth twice as long as the lower; in the rest 3-6 with teeth equally long. Gills usually 3 pairs.

Mostly Eastern states plus Wisconsin, Texas.

3. D. nivea Aiyer, 1930

Hairs and needles single, needles with minute equal teeth. Anterior ventral chaetae 4 per bundle with the upper teeth twice the length of the lower, the rest with equal teeth. Elongate branchial fossa with 3 pairs of gills, one of which may be reduced. The distinction between this and the former species is slight.

Widespread.



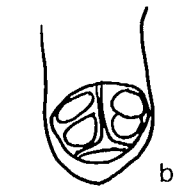
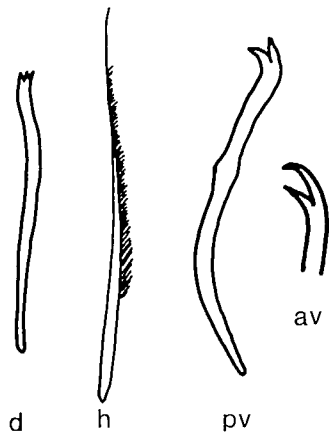

D. pectinata

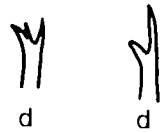

D. trifida

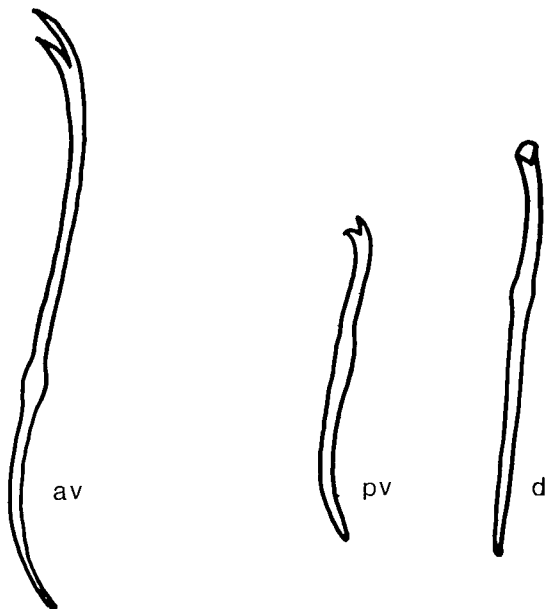
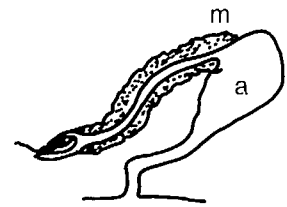

D. abbranchiata

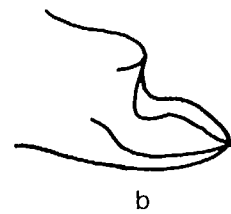

Dero (Dero) (continued)

(B) The names of these species clearly signal the primary distinguishing character.

1. D. pectinata Aiyer, 1930

The single hair chaetae are plumose, the needles with 1 or 2 fine intermediate teeth. Anterior ventral chaetae 4 per bundle, the upper teeth longer than the lower. Posterior ventral chaetae 2-4 per bundle, the upper teeth shorter than the lower. Gills 2 pairs, small and knob-like.

Southern states.

2. D. trifida Loden, 1979

Dorsal bundles with one hair and one bifid or trifid chaeta per bundle, with short divergent teeth. Ventral chaetae of II-V 4-5 per bundle, upper teeth longer than the lower, posteriorly 3-4 with upper teeth of equal length or the upper shorter. Gills 4-5 pairs.

Louisiana, North Carolina.

3. D. abranchiata Harman, 1977

Dorsal bundles with one hair and one spatulate needle. Ventral chaetae of II-III 4-5 per bundle, long with the upper teeth longer than the lower, those behind VIII only 2/3 the length of the anterior chaetae, with shorter upper teeth. Posterior branchial fossa present, but without gills.

Louisiana, Texas.

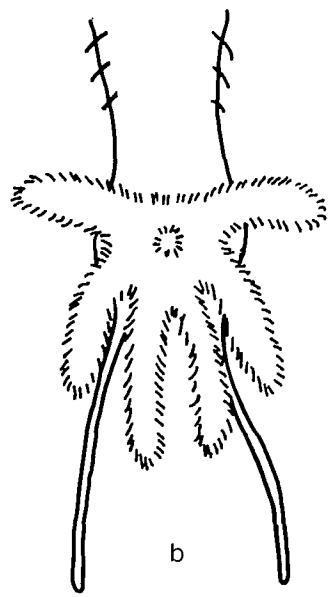

*D. furcata*

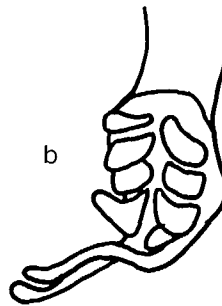
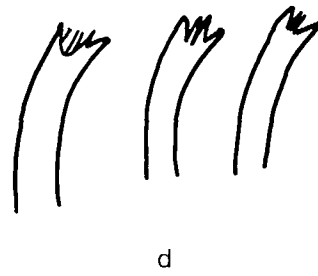

*D. lodeni*



*D. flabelliger*

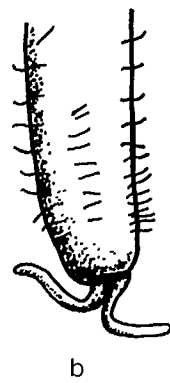

*D. vaga*

DERO (AULOPHORUS) Schmarda, 1861

Two of these species have the dorsal chaetae beginning in VI, and have broadly palmate needles (D. flabelliger and D. vaga), the others have dorsals beginning in V and needles that are bifid or pectinate with few intermediate teeth (D. furcata and D. lodeni).

1. D. furcata (Muller, 1773)

Dorsal chaetae from V, 1 hair and 1 bifid needle with short upper teeth. Ventral chaetae of II-V 2-5 per bundle with the upper teeth a little longer than the lower; in the posterior bundles the teeth are subequal. Gills 3-4 pairs and a pair of palps.

East of a line from Wisconsin to Texas.

2. D. lodeni (= D. pectinatus Stephenson, 1931; D. intermedius Loden & Harman, 1982)

Dorsal chaetae from V, 1-2 hairs and 1-2 pectinate needles. Ventral bundles with 3-4 chaetae anteriorly, 2-5 posteriorly, with teeth about equally long. Gills 4 pairs and a pair of palps.

Johnstown, Pennsylvania; Baton Rouge, Louisiana.

3. D. flabelliger (Stephenson, 1931)

Dorsal chaetae from VI, 1 hair and 1 palmate needle per bundle. Anterior ventral chaetae 5-7 per bundle, with the upper teeth longer than the lower, posteriorly the upper teeth shorter than the lower. Gills 2-3 pairs, long, and a pair of long parallel palps.

Florida, North Carolina, New York.

4. D. vaga (Leidy, 1880)

Dorsal chaetae from VI on, 1-3 hairs and 1-3 palmate needles per bundle. Anterior ventral chaetae 7-14 per bundle with the upper teeth longer than the lower, the rest 4-7 per bundle with the upper teeth very short. Only 1 or perhaps 2 small pairs of gills, and a pair of palps.

Michigan, Massachusetts, Mississippi, Texas.

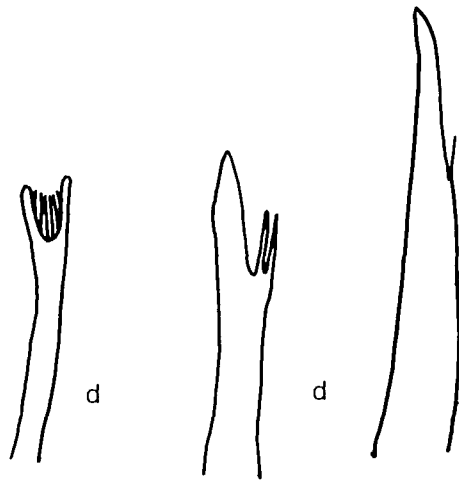

A. pectinata

A. paraguayensis

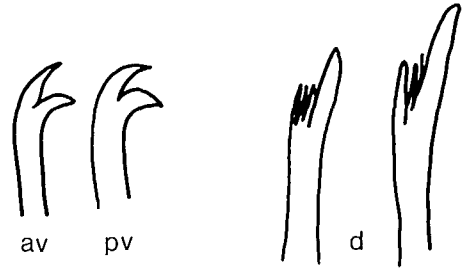

A. inaequalis

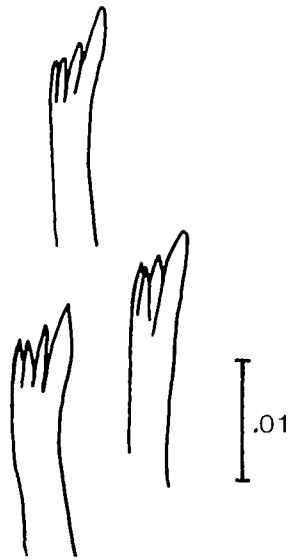

A. paraguayensis  
sensu Hiltunen

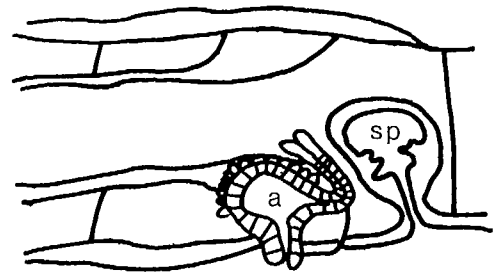

A. paraguayensis

There are two species reported from North America, A. pectinata with pectinate needle chaetae as the name suggests, and A. paraguayensis with distinctive needles with the upper tooth shorter and thinner than the lower or rudimentary, or even totally missing. A third possible species, A. inaequalis, should be considered as a likely addition to the fauna of the southernmost part of North America, partly because it is widely distributed around the rest of the world but mainly because some of the needle chaetae illustrated as being derived from North American A. paraguayensis (1980) seem to resemble those of A. inaequalis in fact. All three will be illustrated, pending a satisfactory revision of the genus. The species are often found in aquaria in places well north of their normal range.

1. A. pectinata (Stephenson, 1910)

Dorsal bundles with 1-2 hairs and 1-2 needles, the needles with pectinate tips, the lateral teeth equally long with a series of fine intermediate teeth. Anterior ventral chaetae 3-5 per bundle, the upper teeth slightly longer than the lower; the rest 2-7 per bundle with teeth equally long\*.

Ontario, Illinois, Ohio, New York, Pennsylvania and Georgia.

2. A. paraguayensis (Michaelsen, 1905)

Dorsal chaetae, sometimes missing in V or VI, consist of 1-2 hairs and 1-2 variable needles with teeth of distinctly different lengths. The thin, short upper tooth may be bifid, single, rudimentary or absent; the lower tooth remains stout. Ventral chaetae 2-6 per bundle, the upper teeth slightly longer than the lower anteriorly but subequal posteriorly.

Louisiana.

3. A. inaequalis (Stephenson, 1911)

Dorsal bundles with 1-2 hair and 1-2 needle chaetae, the needles with unequal lateral teeth and thin intermediate teeth. The ventral chaetae do not differ markedly from those of the other species, and may reach 8 per bundle. Either or both other species became merged with this as a single variable taxon.

Not yet reported.

\* Specimens of Nais variabilis with pectinate needles will key out to A. pectinata, and some confusion may have occurred in the literature. See also N. magnaseta.



*S. appendiculata*

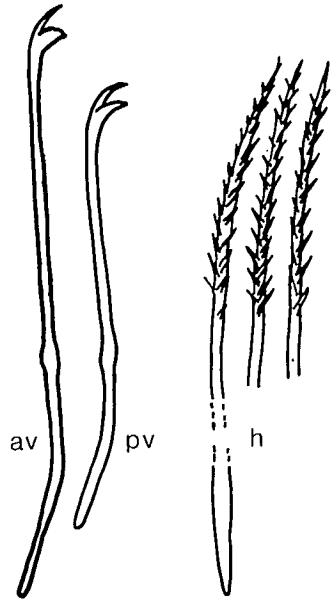
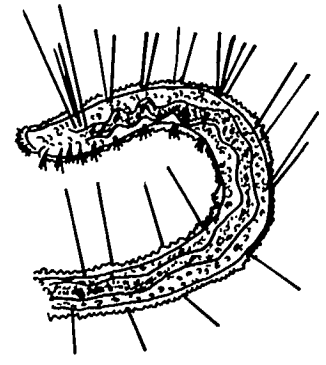
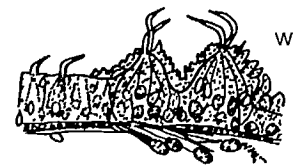
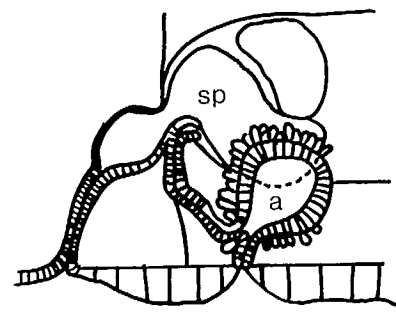

*V. comata*

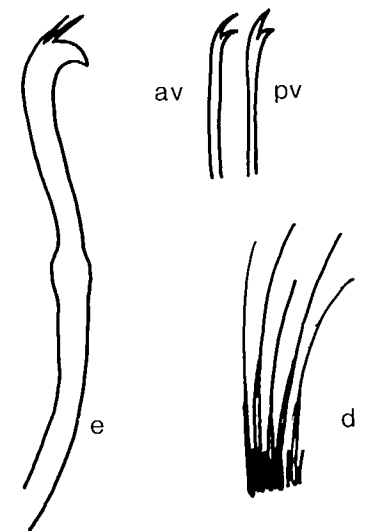
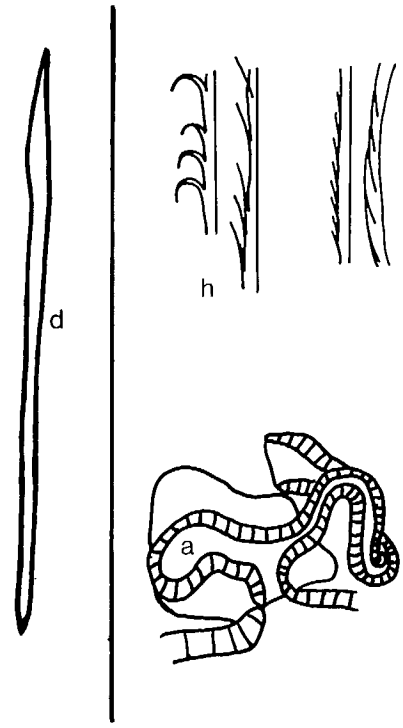

*V. intermedia*

SLAVINA Vejdovsky, 1883; VEJDOVSKYELLA Michaelsen, 1903

These two genera are most readily separable by the elongate hair chaetae in VI in Slavina, and the very large lateral serrations on the hair chaetae in Vejdovskyella. All species in these two genera have ventral chaetae with a strongly bent proximal end and a proximal nodulus. There is a single species in Slavina, two in Vejdovskyella.

1. S. appendiculata (d'Udekem, 1855)

Eyes present. Dorsal bundles in VI with 1-3 very elongate hair chaetae, the rest with 1-2 short hairs, both accompanied by 1 or 2 straight needles with narrow, hair-like distal ends terminating in a slightly distended tip. Ventral chaetae of II a little longer than the rest, those of II-V thinner than the others, the upper tooth longer and a little thinner than the lower. All ventral bundles have 2-5 chaetae. Body wall papillate, with foreign matter attached.

Widespread.

2. V. comata (Vejdovsky, 1883)

Eyes normally present. Ventral chaetae of II long, those of III shorter, those of IV shorter still or absent, and those of V absent; VI and beyond 2-3 chaetae per bundle, rarely replaced by a solitary giant chaeta with a single, thin upper tooth. Dorsal chaetae begin in VI (but apparently in V due to the absence of ventral chaetae in V); each bundle has 4-8 hairs and 1-8 fine, hair-like needles with no nodulus. The needles have slightly broadened tips. The hairs have bifid tips, and the serrations are visible at 250 times magnification. Body wall with scattered papillae.

Washington, Maine, Wisconsin, Maryland, Nova Scotia, British Columbia, North Carolina, South Carolina.

3. V. intermedia (Bretscher, 1896)

No eyes. Ventral chaetae of II-V present, but becoming progressively smaller to V; VI and beyond only 1 per bundle. In some or all ventral bundles of VI-VIII there are giant ventral chaetae with replicated upper teeth. Dorsal bundles with 4-9 simple-pointed hair chaetae with coarse serrations visible at 400 times magnification, plus 4-9 simple-pointed needle chaetae with slightly broadened tips. Body wall with gland cells and attached foreign matter.

St. Lawrence Great Lakes drainage and the Hudson, Potomac and Illinois River systems; Fraser River, British Columbia.



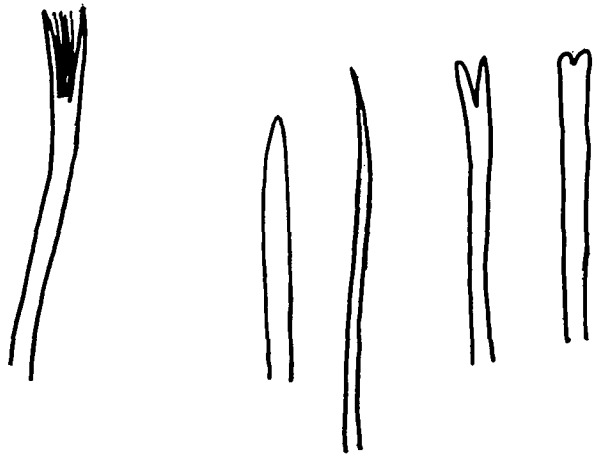

pectinate needle

simple pointed  
needle

bifid needles

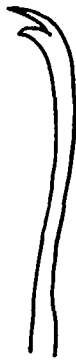

av



pv



d



N. magnaseta

NAIS Muller, 1773

There are eleven species in this genus in North America. They are separable by the following chaetal characteristics:

- |   |         |       |
|---|---------|-------|
| 1. Needle chaetae in dorsal bundles pectinate. No enlarged ventral chaetae.                     | Group A | below |
| 2. Needle chaetae simple-pointed. Thickened ventral chaetae may replace normal chaetae from VI. | Group B | p. 91 |
| 3. Needle chaetae bifid; enlarged or giant chaetae present in some anterior ventral bundles.    | Group C | p. 95 |
| 4. Needle chaetae bifid; no enlarged ventral chaetae.   | Group D | p. 97 |

Specimens of Dero with the posterior end (that bears the characteristic gills) missing may be mistaken for Nais species, but the chaetal characteristics should enable this error to be corrected. However, both genera have anterior ventral chaetae longer and thinner than those of posterior bundles.

(A)

1. N. magnaseta Harman, 1973

This species has been regarded as potentially a member of Allonais (Hiltunen & Klemm, 1980). There are 1-2 hairs and 1-2 pectinate needles with long divergent teeth and short intermediate teeth. Ventral chaetae 2-5 per bundle, with the upper teeth longer than the lower anteriorly but teeth equally long behind VI\*.

A single specimen, Texas.

\* Some specimens of Nais variabilis have pectinate needles, which causes confusion, see Allonais (page 85).

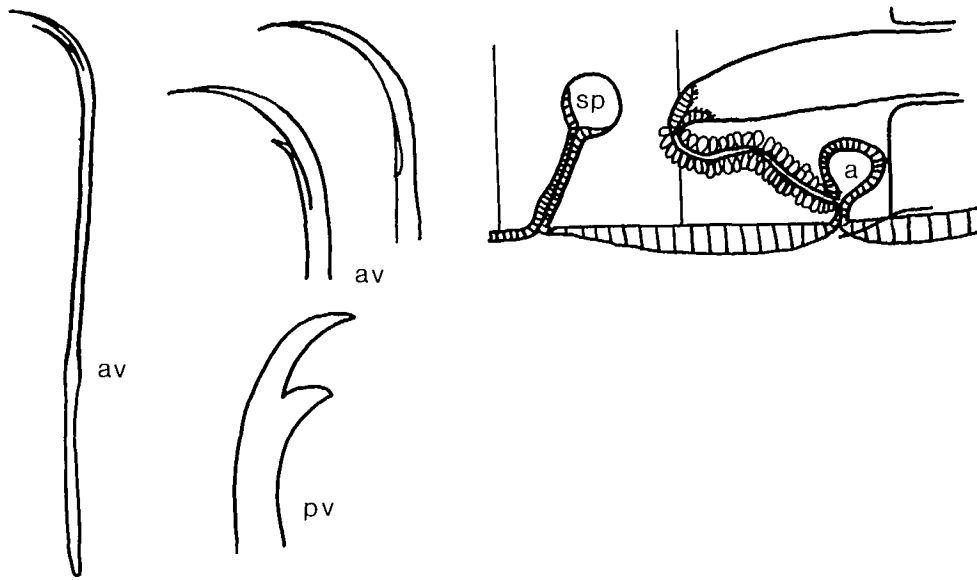

N. behningi

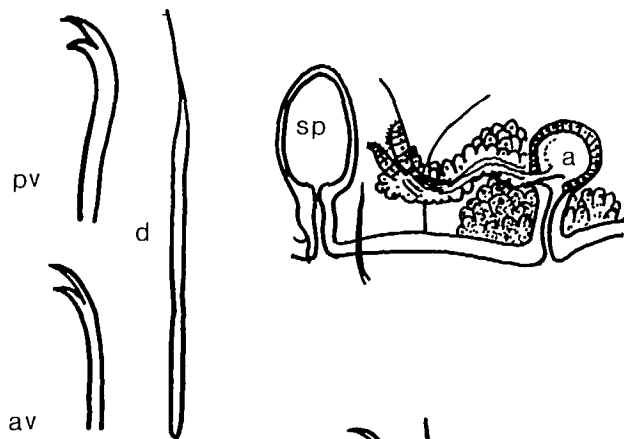

N. pseudobtusa

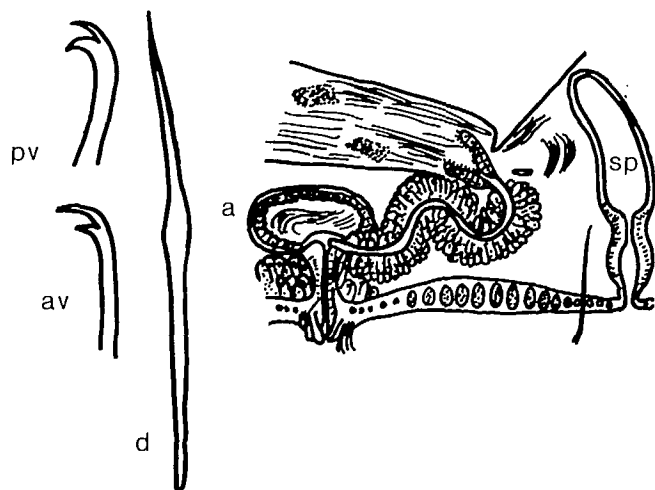

N. barbata

Nais (continued)

(B) There are five species in this group. The ventral chaetae of N. behningi are unique, with their huge upper teeth and often rudimentary lower teeth. The needle chaetae are thin and hair-like at the tip in N. barbata, N. pseudobtusa and N. behningi but are broad-tipped in N. alpina and N. simplex, which are described on the following page.

1. N. behningi Michaelsen, 1923

Hair and needle chaetae 1-2 per bundle, needles thin and hair-like distally. Ventral chaetae of II-V 6-10 per bundle with enormously long upper teeth strongly curved over the short or rudimentary lower teeth; those of VI and beyond more normal but with the upper teeth twice as long as the lower, or replaced by thickened chaetae with the lower tooth reduced in length. Hiltunen & Klemm (1980) suggest an overlap in characters with N. pseudobtusa. D. Lenat (pers. comm.) suggests that the anterior third may be bright purple!  
Widespread.

2. N. pseudobtusa Piguet, 1906

Hairs and needles each 1-3 per bundle, needles with long pointed tips. Both anterior and posterior ventral chaetae with upper teeth longer than the lower, 2-5 in II-V, longer, straighter and thinner than the rest, 2-6 in the rest with the upper tooth thinner than the lower.  
Widespread but sporadic.

3. N. barbata Muller, 1773

Up to 5 hairs and 5 needles with long pointed tips present. Ventral chaetae of II-V much longer, thinner and straighter than the rest, with the upper teeth longer and thinner than the lower; those of VI and beyond with teeth equally long. The number of dorsal chaetae is unique in the genus.  
St. Lawrence, Mississippi, Penobscot (Maine), Illinois River systems.



*N. alpina*

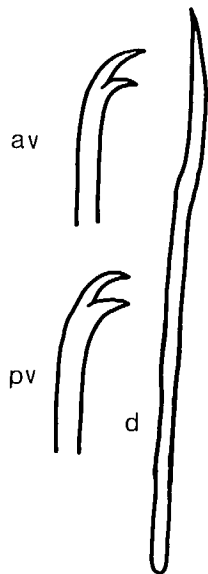
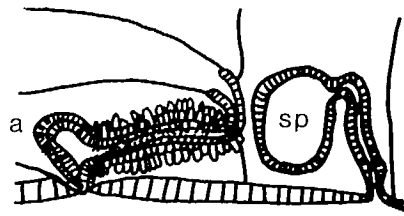

*N. simplex*

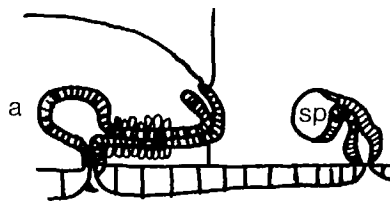

Nais (continued)

These two species are separable on the basis of the ventral chaetae, the upper teeth of which are longer than the lower in posterior bundles in N. alpina but as long as the lower in N. simplex.

4. N. alpina Sperber, 1948

Dorsal bundles with 1-2 hairs and 1-2 broad tipped simple pointed needles. Anterior ventral chaetae with upper teeth twice as long as the lower; the rest also have long upper teeth, 3 or 4 to 7 per bundle throughout.

Lake Ontario, Michigan, British Columbia.

5. N. simplex Piguet, 1906

Dorsal bundles with 1-2 hairs and 1-2 broad tipped simple pointed needles. Ventral chaetae of II-V 2-6 per bundle with upper tooth twice as long as the lower; teeth equally long or slightly longer than the lower in the rest.

Widespread east of the Mississippi; Kitimat, British Columbia.

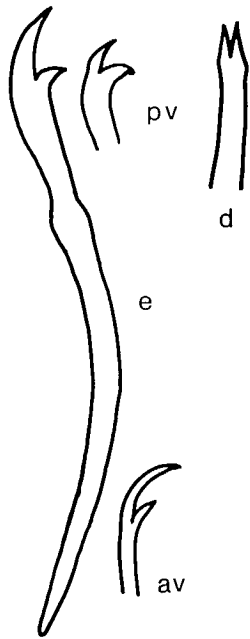

*N. pardalis*

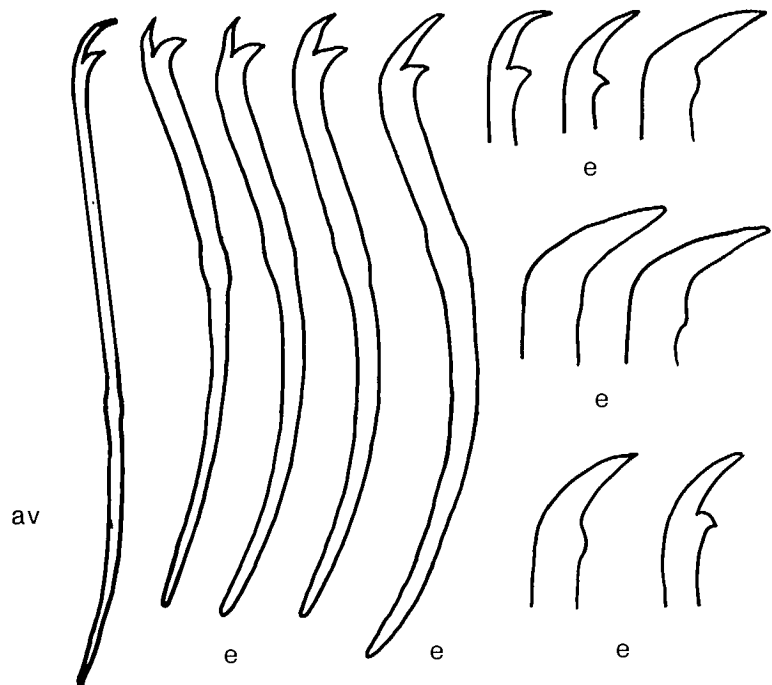
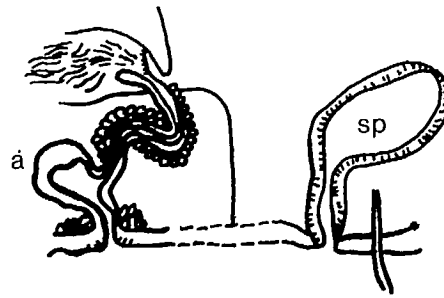

*N. bretscheri*

Nais (continued)

(C) There are two species in this group. N. pardalis may have enlarged chaetae from VI, N. bretscheri has giant chaetae in addition. Both have needles with fairly long, more or less parallel teeth.

1. N. pardalis Piguet, 1906

Hairs and needles 1-2 per bundle, needles with fine, equal teeth. Ventral chaetae of II-V 2-5 per bundle, upper teeth much longer than the lower; from VI on 1-5 per bundle of two forms: (a) normal chaetae with teeth of very variable length, (b) thick chaetae with upper teeth 2-3 times as long as the lower. Piguet originally decided that this was merely a variant of N. bretscheri. Hiltunen & Klemm (1980) suggest considerable seasonal and spatial variation in chaetal form, and possible confusion with N. variabilis.  
Widespread.

2. N. bretscheri Michaelsen, 1899

Dorsal chaetae 1-2 needles with equal, parallel teeth and 1-2 short hairs. Ventral bundles of II-V 2-7 chaetae with the upper tooth about twice as long as the lower; from VI 1-6 chaetae per bundle, exceedingly variable but including solitary giant chaetae, and some enlarged chaetae with upper teeth 2-3 times longer than the lower.  
Widespread.

Note that giant chaetae are now known to appear in older specimens of Pristina aequisetata, so that both of these Nais species may be part of the N. variabilis complex, as noted by Hiltunen and Klemm (1980).



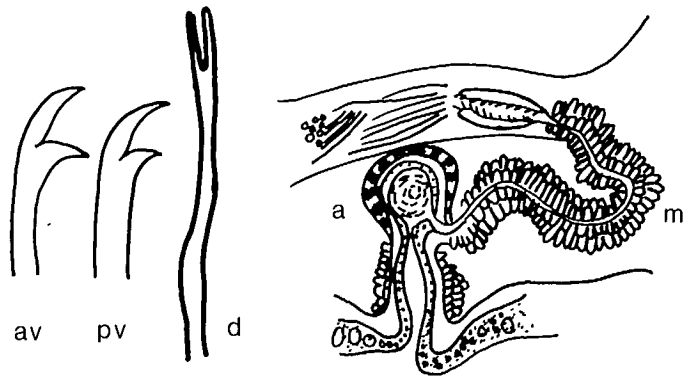

*N. elinguis*

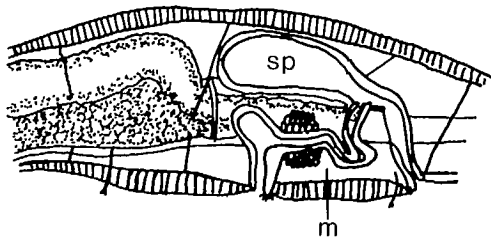

*N. communis*

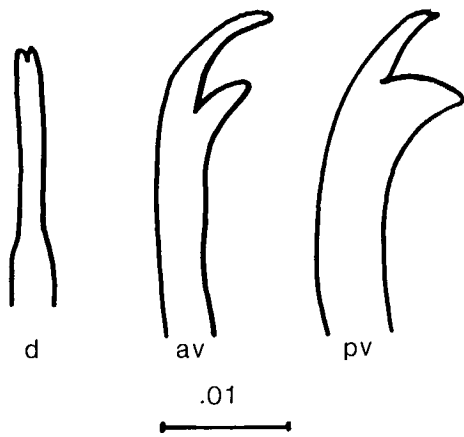
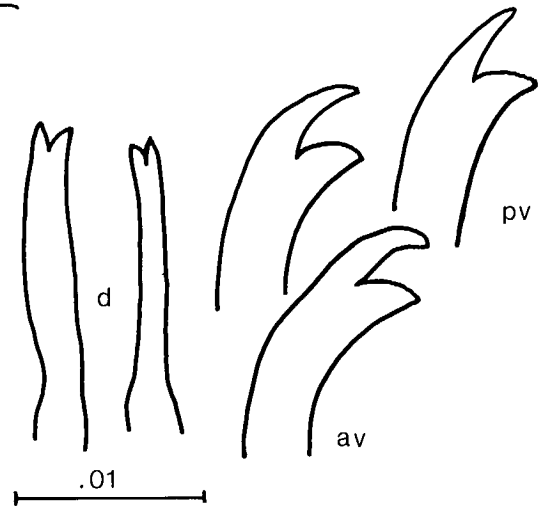

*N. variabilis*

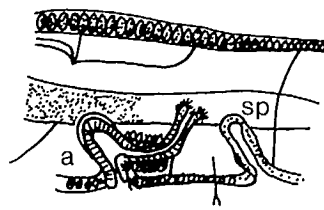

Nais (continued)

(D) Nais elinguis has several hair and needle chaetae and has unique long parallel needle teeth. The other two species may be difficult to separate from each other.

1. N. elinguis Muller, 1773

There are 1-3 hairs and 1-3 needles in dorsal bundles, the needles with long teeth closely parallel to each other (which may appear short if viewed at other than a fully lateral aspect). Ventral chaetae of II-V not so markedly different in length and width from the rest as in other Nais species. Both anterior and posterior ventral chaetae 2-5 per bundle, all with the upper teeth up to twice the length of the lower.

Widespread.

2. N. communis Piguet, 1906

Eyes usually present. There are 1-2 hair chaetae and 1-2 needles in dorsal bundles, the divergent teeth of the needles clearly visible at 40x. There are 2-6 anterior ventral chaetae per bundle, not very different from posterior chaetae. The gradual widening of the stomach is said to be diagnostic, as is the inability of this species to swim.

Widespread.

3. N. variabilis Piguet, 1906

Eyes present or absent. Hair chaetae and needle chaetae both 1-2 per bundle, needle teeth may be inconspicuous, visible at 100x. The ventral chaetae of anterior bundles have the upper teeth twice as long as the lower, the posterior ones have teeth of equal length. Both size and shape of ventral chaetae change abruptly at V/VI. The stomach widens abruptly.

Widespread.

There are specimens of N. variabilis with exceptionally long hair chaetae (up to 700 um instead of 200-300 um) and the chaetae are as variable as the name suggests. Specimens with pectinate needles will key out as Allonais pectinata (page 85). Specimens of N. pardalis lacking enlarged ventral chaetae will key out to here (see previous page).

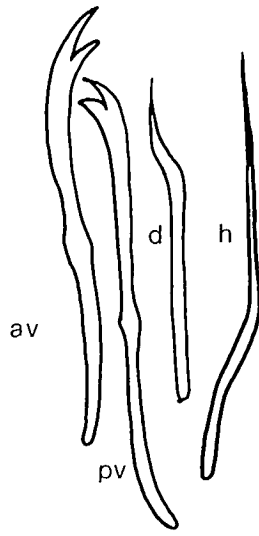

S. trivandrana

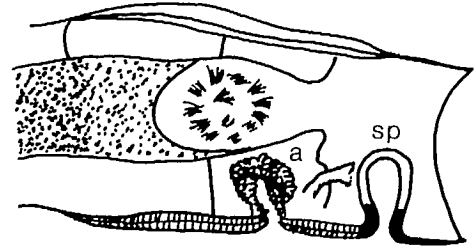

S. trivandrana

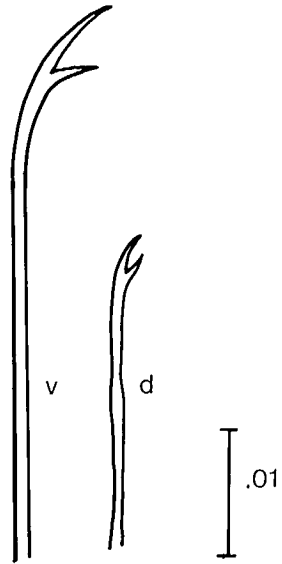

S. tandyi

BRATISLAVIA Kose, 1976; PRISTINELLA Brinkhurst, 1984;  
STEPHENSONIANA Cernosvitov, 1938

Stephensoniana is separable from the other genera by the following body wall characteristics:

- |   |   |       |
|---|---|-------|
| 1. Body wall covered with foreign matter adhering to glandular secretions of the body wall. | <u>Stephensoniana</u>                     | below |
| 2. Body wall naked.   | <u>Bratislavia,</u><br><u>Pristinella</u> | p.101 |

1. S. trivandran (Aiyer, 1926)

There are 3-4 hair chaetae and 3-4 simple-pointed needles in anterior bundles, with a similar number of ventrals. The upper teeth of the ventral chaetae are longer than the lower.

West Virginia, Illinois, Pennsylvania, Maryland and Texas.

2. S. tandyi Harman, 1975

Dorsal bundles have 1-2 hair chaetae and a single bifid needle with the upper tooth longer than the lower and a characteristic shape with long curved upper tooth and short curved, thin lower tooth. Ventral chaetae one, rarely two, with very long thin upper teeth, diverging from the lower at a wide angle. The posterior third of the body lacks chaetae.

Louisiana, Maryland and Virginia.

There is less foreign matter on the body wall in the latter.

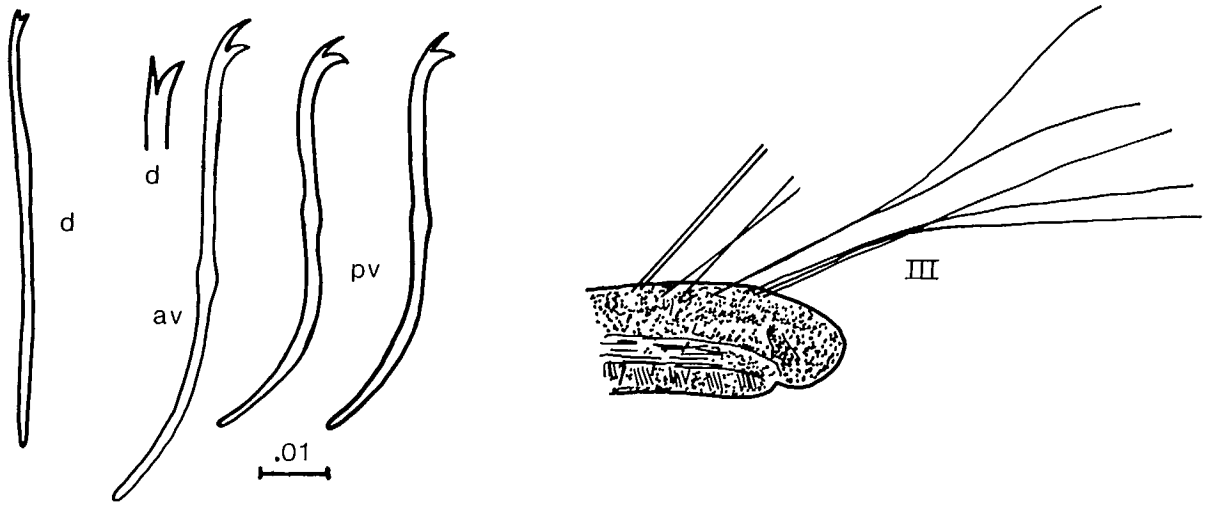

*B. bilongata*

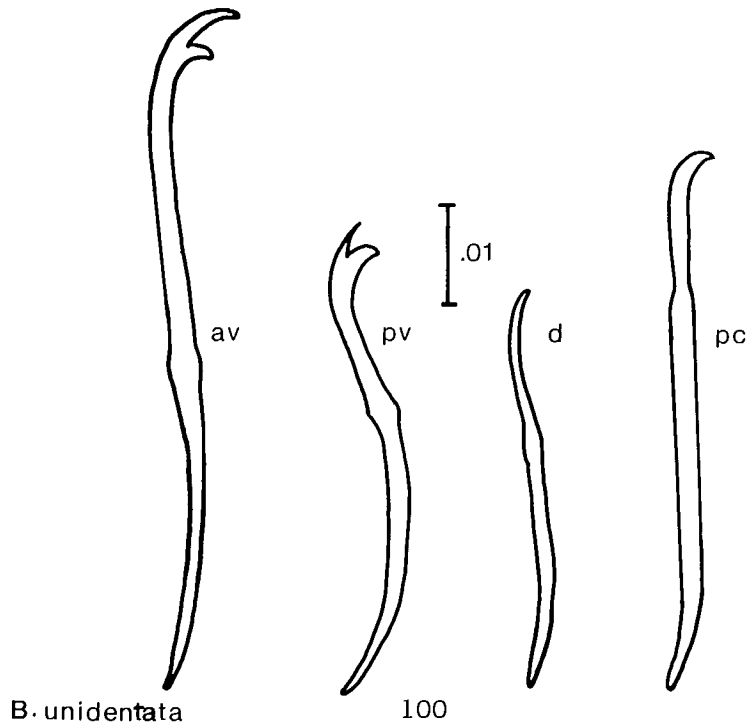

*B. unidentata*

Bratislavia, Pristinella, Stephensoniana (continued)

Bratislavia and Pristinella can be separated as follows:

- |  |                    |       |
|--|--------------------|-------|
| 1. Dorsal chaetae begin in III,<br>hair chaetae of II elongate,<br>or dorsal chaetae begin in<br>II, hair chaetae longest in<br>midbody and exceedingly thin,<br>missing in many bundles*. | <u>Bratislavia</u> | below |
| 2. Dorsal chaetae begin in II,<br>hair chaetae not exceptionally<br>thin, present in all dorsal<br>bundles.  | <u>Pristinella</u> | p.103 |

The two Bratislavia species are readily separable on chaetal characters.

1. B. bilongata (Chen, 1944)

Dorsal chaetae from III, 2 non-serrate hairs and 2 needles anteriorly, the hair chaetae of III elongate. Needles bifid with short teeth of about equal length. Ventral chaetae 6-10 per bundle anteriorly, 4-6 posteriorly, with the upper teeth longer than the lower anteriorly, progressively reducing in relative length until the upper teeth are shorter than the lower posteriorly.

New Jersey, Florida.

The account by Chen (1944) suggests there are elongate hairs on III or IV. Harman & Loden (1979) reported no dorsal chaetae in IV in the two specimens obtained.

2. B. unidentata (Harman, 1973)

Dorsal chaetae 1 hair, non-serrate and unusually thin (100- 185 um x 1 um) which may be missing in many bundles, and 1 bluntly simple-pointed nodulate needle. Ventral chaetae 3 per bundle anteriorly, with upper teeth twice the length of the lower, with a proximal nodulus; in posterior segments the 3-4 shorter ventral chaetae have a proximal nodulus, and slightly shorter, thinner upper teeth.

Illinois, Texas, Ohio, North Carolina, Maryland and Virginia.

\* Elongate hair chaetae are present in III in P. longisoma, in which dorsal chaetae begin in II.

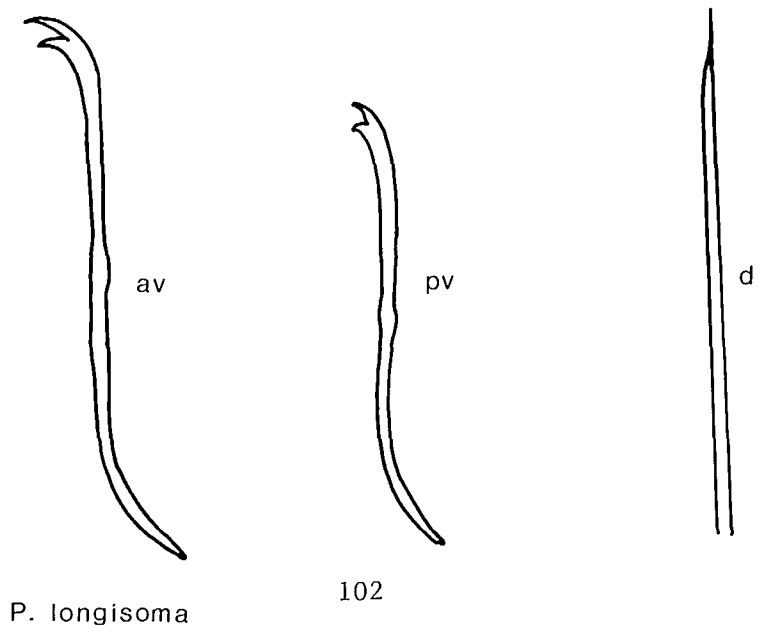
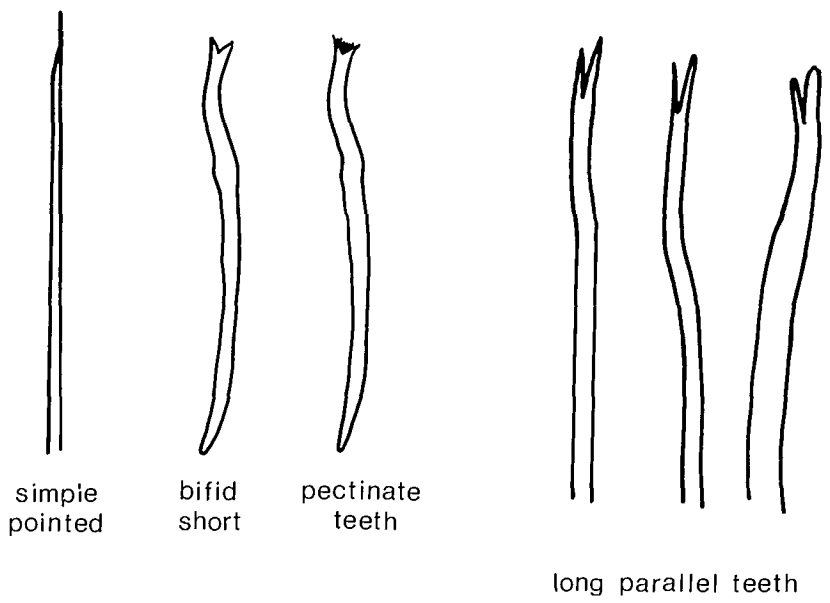

Bratislavia, Pristinella, Stephensoniana (continued)

Species of Pristinella can be separated as follows:

- |  |         |       |
|--|---------|-------|
| 1. Needle teeth simple-pointed;<br>hair chaetae of III elongate.                     | Group A | below |
| 2. Needle teeth short divergent,<br>bifid to pectinate; no<br>elongate hair chaetae. | Group B | p.105 |
| 3. Needle teeth long, parallel;<br>no elongate hair chaetae.                         | Group C | p.107 |

(A) There is a single species in this group.

1. P. longisoma Harman, 1977

Dorsal chaetae 3-4 long non-serrate hairs, 2-4 sharply simple pointed unnodulate needles. Ventral chaetae of II-V 3 per bundle with a distal nodulus, the upper teeth slightly longer and thinner than the lower.  
Louisiana.

This worm is large for a Pristinella; it might become assigned to Bratislavia once mature specimens are described.



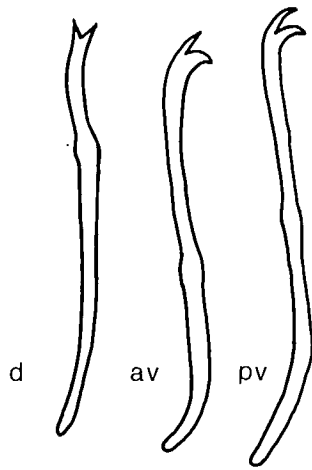

P. osborni

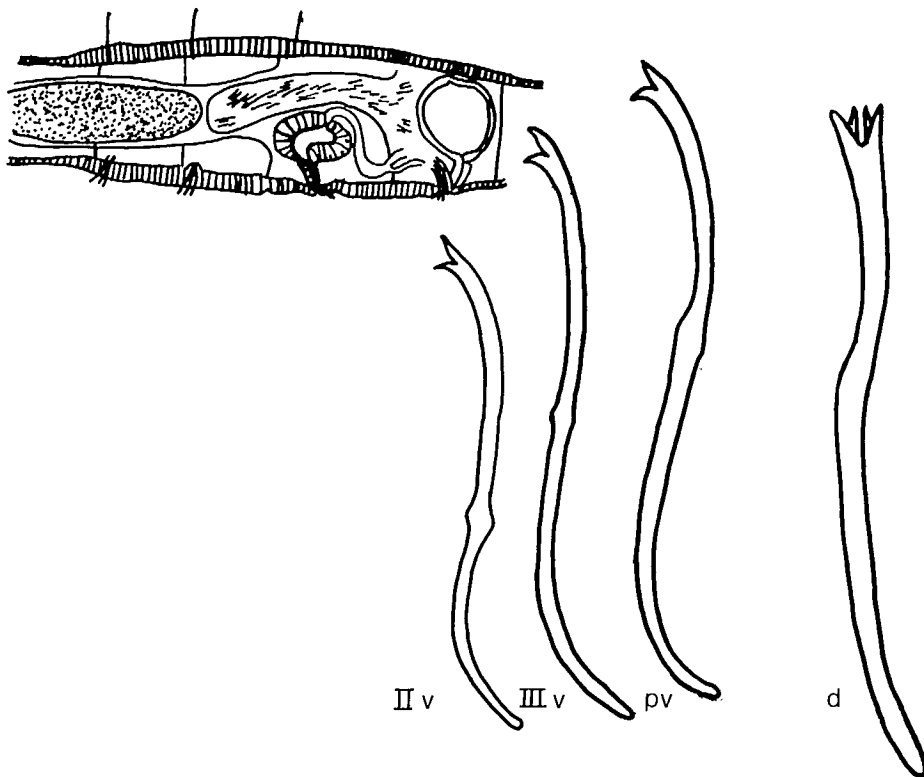

P. sima

Bratislavia, Pristinella, Stephensoniana (continued)

(B) There are supposedly three species in this group which, until recently, could be separated by the presence of intermediate teeth (pectinations) between the lateral needle teeth in P. sima, whereas the others were described as having bifid chaetae until pectinations were reported in some specimens of P. osborni by Loden & Harman (1980). Hiltunen & Klemm (1980) have already indicated that the two are unseparable if the pectinations of P. sima are not visible. The differences between the species are reduced to the suggestion that the upper tooth of the needle is longer in P. osborni than in P. sima (Loden & Harman 1980). Inspection of the illustrations of all three species suggests very similar needles with divergent teeth, the upper a little shorter than the lower. The third species in the group, P. minuta was thought to be a possible synonym of the poorly described P. osborni by Sperber (1948) pending re-description of the North American taxon, and by Hiltunen & Klemm (1980). These are probably all the same taxon, in which case the name osborni takes precedence.

1. P. osborni (Walton, 1906)

Dorsal chaetae 1 non-serrate hair and 1 bifid or pectinate needle per bundle. Ventral chaetae 3-5 anteriorly with upper tooth longer than lower, posteriorly becoming fewer with the teeth becoming equally long. Hair chaetae to 190 um, needles 30-45, ventrals 30-45 um long.

East of a line from Wisconsin to Louisiana.

2. P. minuta (Stephenson, 1914)

Dorsal chaetae 1 non-serrate hair and 1 needle with short, widely diverging teeth of equal length. Ventral chaetae 3-5 per bundle anteriorly. The specimens from the sole American locality (Bee county, Texas, Harman, 1973) are said to differ from P. osborni because of setal length differences (hairs 77-105 um, needles and ventrals 33-37 um), the ventrals increasing in length from II-VI. Harman (1973) expressed some doubt about the independence of this species from the former.

Texas.

P. notopora Cernovitov, 1937 is included in a key to the fauna of the Carolinas; it is very similar to P. minuta but has serrate hairs and the needle teeth diverge at an acute angle. I do not know of any documented record of this species in North America.

3. P. sima (Marcus, 1944)

Dorsal chaetae 1 non-serrate hair and 1 needle with diverging teeth and usually 2-3 intermediate teeth. Ventral chaetae 3-5 per bundle anteriorly with upper teeth longer than the lower, shorter in the rest.

Mississippi and large Northeastern rivers, small streams in Virginia.

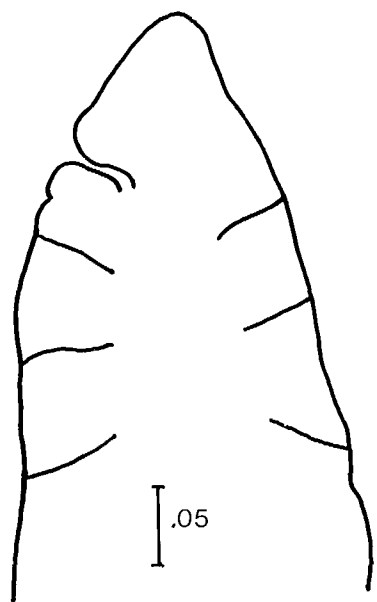

*P. longidentata*

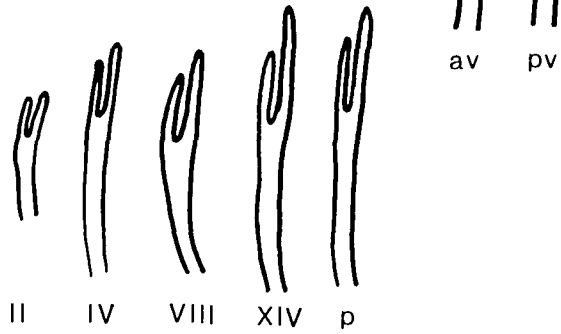
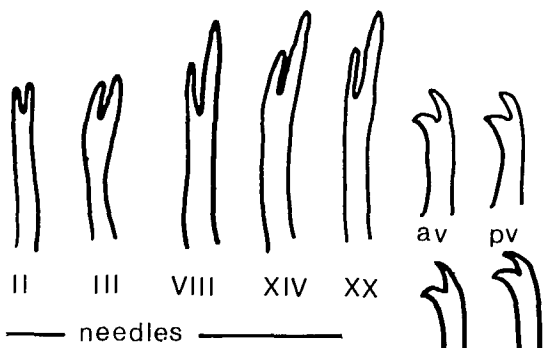
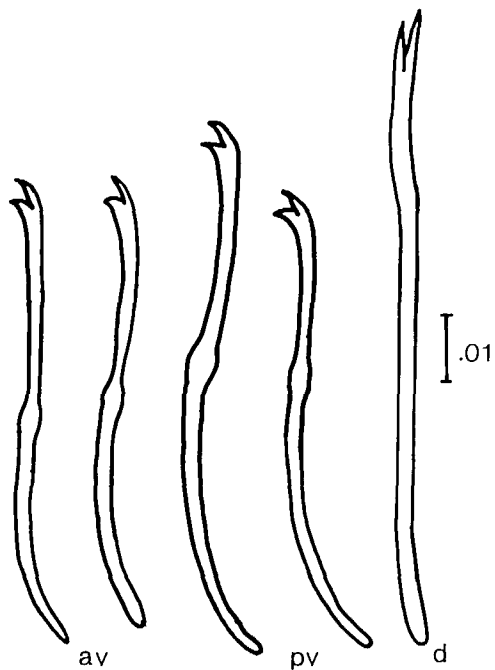

*P. jenkiniae*

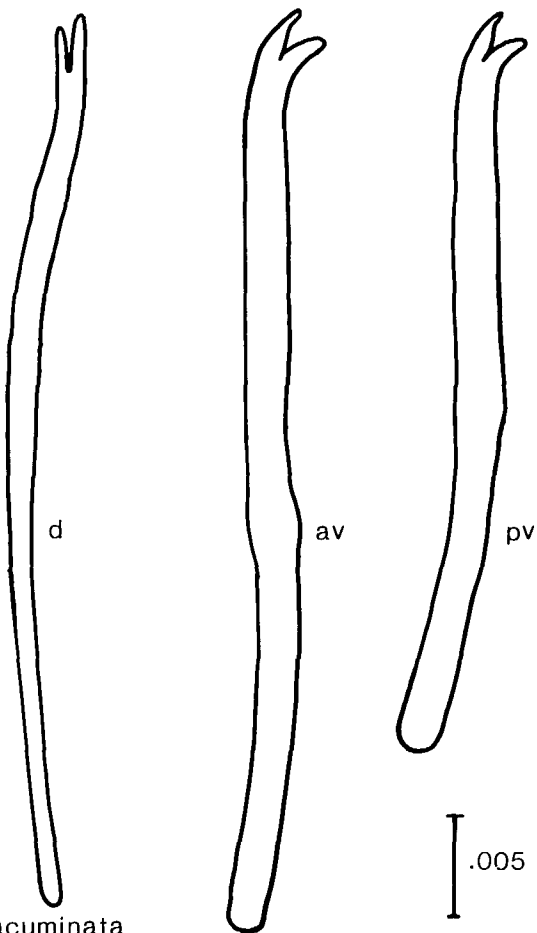

*P. acuminata*

Bratislavia, Pristinella, Stephensoniana (continued)

(C) There are three species in this group, but two are very similar and have been declared synonyms in the past (Brinkhurst & Jamieson 1971), but Harman (1974) showed that there are some differences between the two, such as serrate hair chaetae in P. longidentata and non-serrate hairs in P. idrensis. The chaetal sizes also differ and needles are supposed to differ slightly. In P. longidentata there is a single hair and a single needle in each bundle but in P. acuminata there are 2-5 of each.

1. P. longidentata (Harman, 1965)

Dorsal chaetae 1, rarely 2, finely serrate hairs and 1 needle, curved distally, with long parallel teeth, the upper shorter than the lower; hair chaetae up to 460 um long, needles 50-100 um. Ventral chaetae 4-5 per bundle, upper teeth longer anteriorly, equal to the lower posteriorly, 63-91 um long.

Oklahoma, Louisiana.

2. P. jenkiniae (Stephenson, 1931) (= P. idrensis Sperber, 1948)

Dorsal chaetae 1-2 non-serrate hairs with 1-2 needles that are curved distally and bifid with long parallel teeth, the upper often thinner than and from half as long to nearly as long as the lower. Ventral chaetae 2-9 (usually 4-6) anteriorly, 2-3 (rarely 4-5) posteriorly, all teeth equally long; chaetal size variable.

Widespread.

This may be a form of the widespread P. amphibiotica Lastockin, 1927, as yet unreported from North America. Kathman (1986) showed that P. idrensis is a synonym of P. jenkiniae.

3. P. acuminata (Liang, 1958)

Dorsal chaetae 2-5 finely serrate hairs, 2-5 bifid needles, with slightly diverging teeth, the upper longer than the lower. Ventral bundles with 3-4 chaetae with teeth of equal length.

Lake Erie, Ohio River.

Hiltunen & Klemm (1980) question the identity of the North American specimens and the type material in China is inaccessible. Lack of serrations on the hair chaetae (observed by them) may not be a serious difference; other reasons for questioning the identity of the material were not quoted. The only record is by Spencer (1978).

Specimens with long, parallel teeth on the needles and non-serrate hairs less than 400 um long may belong to Pristina breviseta (page 69) which may lack a proboscis in some specimens.



## TUBIFICIDAE

There are probably fewer contentious issues in terms of species separations in this family, but some issues should be noted. The genus Limnodrilus provides many problems, largely because of a lack of distinguishing characters other than the form of the penis sheath. While the long sheaths grow quite rapidly to judge by the shortage of specimens in which the structures are partially developed, care should be taken with identifications of unmated animals (without sperm in the spermathecae) in which the form of the head of the penis sheath may be typical when the length is not.

The Peloscolex complex has been divided, with the present version being an attempt to avoid the confusion that would be created by following more radical solutions. Similar problems attend recent attempts to revise Tubifex based on a selective survey of both species and published descriptions. Some of these changes have been accepted here.

Species with hair and pectinate chaetae may be represented by specimens with very few, short hairs plus bifids, or even nothing but bifid chaetae. Experimental work on this is in progress, but there is a growing awareness that environmental factors, like those associated with the water chemistry in oases, spring fed streams, estuaries and grossly polluted habitats cause this chaetal shift within a species.

The term cuticular penis sheath is used here for any structure visible in whole mounts, regardless of whether it is permanently attached to the penis or has a soft penis loose within it. When the penis sheath is, in reality, the basal membrane of penial muscles it is called an apparent penis sheath.

The name Peloscolex variegatus Leidy is regarded as associated with a forgotten name associated with an undefinable species. Similar problems surround the name Ilyodrilus because of the inadequate description of the type species. Several of these names were attached to recognizable but later taxa by W. Michaelsen and have become firmly entrenched in the literature. The generic name Isochaetides may become restricted to species from Lake Baikal in the future.

With practice, many immature specimens can be identified by their chaetal form and number, but in many large collections biologists will have to be content to divide those immature specimens into those with unexceptional bifid chaetae in all bundles, or those with unexceptional hair and pectinate chaetae in dorsal bundles. They may be allocated to species on the basis of the percentage abundance of the mature specimens that are usually present in any population.

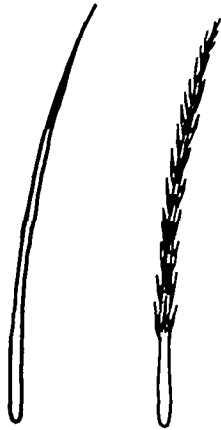

hair

serrate  
hair



bifid



pectinate



palmate



duplicate  
upper tooth

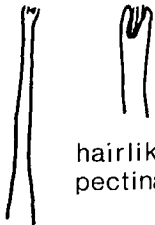

hairlike with  
pectinate tip

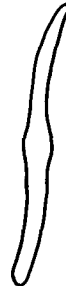

simple  
pointed

## TUBICICIDAE

### Separation of Primary Groups

- |   |         |       |
|---|---------|-------|
| 1. Hair chaetae present in dorsal bundles, accompanied by palmate chaetae.  | Group 1 | p.113 |
| 2. Hair chaetae present in dorsal bundles, accompanied by pectinate chaetae.  | Group 2 | p.115 |
| 3. Hair chaetae present in dorsal bundles, accompanied by either bifid chaetae, or chaetae with the thin, short upper teeth duplicated.   | Group 3 | p.131 |
| 4. Hair chaetae present in dorsal bundles, accompanied by short thin hair-like chaetae that may have minute bifid or pectinate tips, these chaetae obscured by the papillate body wall (Note that papillate species are found in other groups). | Group 4 | p.135 |
| 5. No hair chaetae in dorsal bundles. All dorsal chaetae bifid or simple pointed anteriorly.  | Group 5 | p.137 |





palmate dorsal  
*P. barbatus*



SC

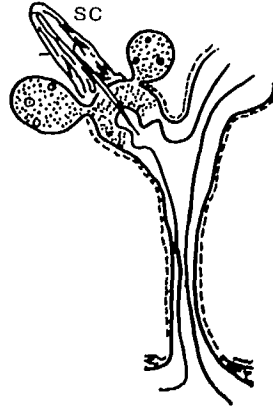

palmate  
*A. wulikensis*

TUBIFICIDAE

GROUP 1

Species with hair and palmate chaetae in dorsal bundles:

1. Dorsal chaetae broadly palmate. Ventral chaetae of X modified spermathecal, thin, hollow-tipped. This European species has probably been introduced to its solitary North American location, the freshwater estuary of the St. Lawrence River, Quebec.

Psammoryctides barbatus p.155

2. Dorsal chaetae approaching palmate but with outer teeth still detectably wider than the intermediate teeth. No modified genital chaetae. This species is thus far limited to the Wulik River drainage of the Brooks Range, Alaska.

Arctodrilus wulikensis p.181

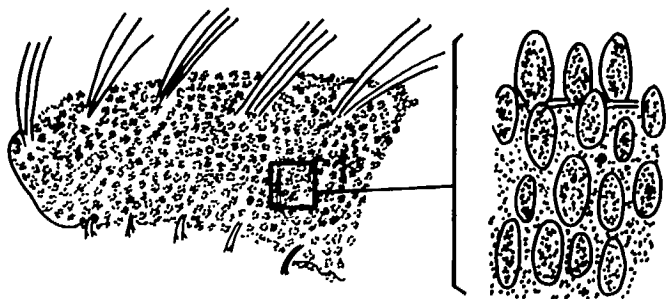

papillate body wall

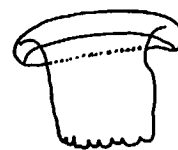

penis sheaths

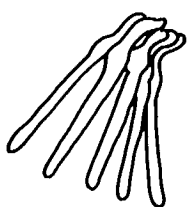

penial



slightly modified penials

penis sheath



spermathecal  
and penial

*H. speciosus*

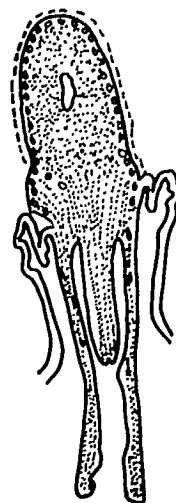

everted penis



spermathecal chaetae



*P. bedoti*

## TUBIFICIDAE

### GROUP 2 (from page 111)

Species with hair and pectinate chaetae dorsally.

1. Body wall distinctly papillate.  
No modified genital chaetae, but  
cuticular penis sheaths present.                      Section A                      p.117
2. Body wall non-papillate.  
No modified genital chaetae, but  
cuticular penis sheaths present.                      Section B\*                      p.119
3. Body wall non-papillate.  
Penial chaetae on XI with short  
distal ends, often arranged in  
fan-like bundles, tips modified;  
penis sheath absent.                      Section C                      p.125
4. Body wall non-papillate.  
Penial chaetae on XI bifid, only  
slightly different from normal  
ventrals; thin conical penis  
sheaths.                      Section D\*                      p.127
5. Body wall non-papillate.  
Modified spermathecal chaetae on  
X ventrally, penis sheaths thin  
or absent.                      Section E                      p.129
6. Papillae absent from body wall. Spermathecal chaetae replace the normal  
ventral chaetae on VII-VIII or any or all of VI-XII (spermathecal pores  
on VIII rather than the normal X, penes on IX). Penis sheath absent.  
St. Lawrence Great Lakes, Cayuga Lake, N.Y.  
Potamothrix bedoti                      p.157
7. Papillae absent from body wall. Spermathecal and penial chaetae in X and  
XI. Very thin short cylindrical apparent penis sheaths present.  
New York, Maryland, Virginia and S. Carolina, tidal freshwater.  
Haber cf. speciosus                      p.183

\*The distinction between groups B and D may prove difficult, but note that group D species are limited to northwestern North America.

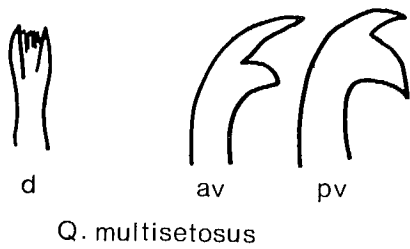
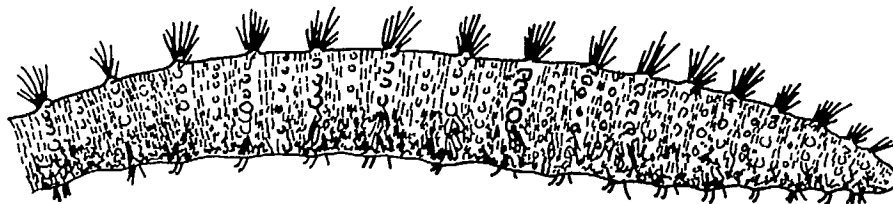
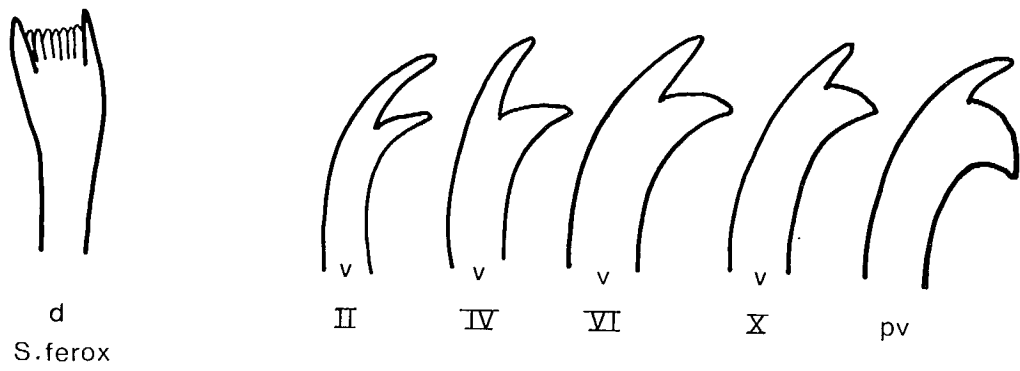
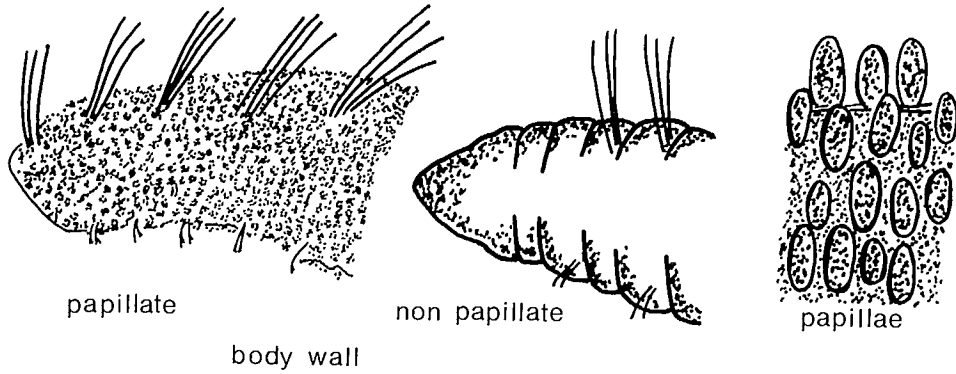

TUBIFICIDAE: Group 2 (continued)

Section A  
(from page 115)

These two papillate species have hair and pectinate chaetae dorsally but no modified genital chaetae. Cuticular penis sheaths are present, if sometimes thin, often obscured by the body wall papillae in whole mounted specimens. The ventral chaetae of X and/or XI either normal or absent.

1. Body wall papillate to a variable extent up to a dense close covering. Dorsal chaetae up to 7 hairs and 5 pectinates, 2-5 or 7 ventral chaetae per bundle. The anterior ventral chaetae beyond III have teeth of about equal length and breadth, posterior ventral chaetae with short, thin upper teeth.

Widespread, eastern North America.

Spirosperma ferox

p.185

2. Body wall with rows of very large papillae especially in the chaetal line, as well as relatively sparse covering of smaller papillae. There can be up to 14 hair chaetae in each dorsal bundle, and the 2-3 chaetae of all anterior ventral bundles have distinctly elongate upper teeth. In one form (longidentus) the posterior ventral chaetae are like those of the anterior bundles, but the typical form has posterior ventral chaetae with short upper teeth and strongly recurved lower teeth.

Eastern North America, British Columbia, Washington.

Quistadrilus multisetosus

p.189

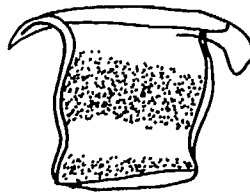

short penis sheath

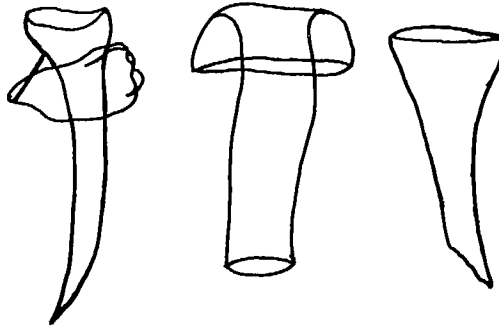

long penis sheaths

TUBIFICIDAE: Group 2 (continued)

Section B  
(from page 115)

The species of this group have hair and pectinate chaetae dorsally, no modified genital chaetae but cuticular penis sheaths. The ventral chaetae of X and/or XI are either normal or absent. Papillae are absent from the body wall. For ease of identification it is convenient to divide these species into two subgroups as follows:

1. Species with short, often  
inconspicuous penis sheaths. (a) p.121
2. Species with distinct penis  
sheaths longer than broad. (b) p.123



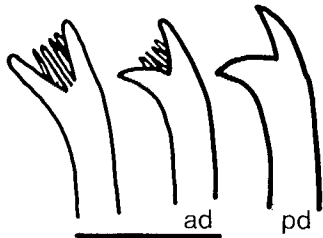

T. tubifex

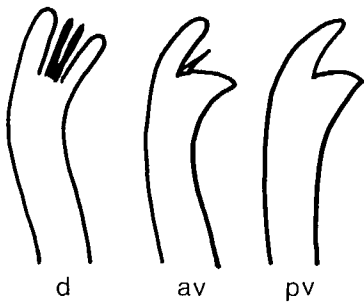
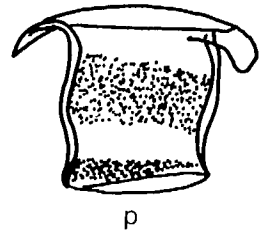
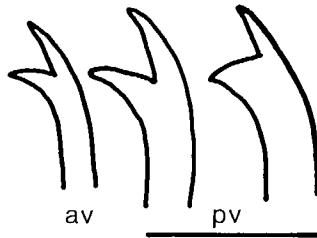

T. ignotus

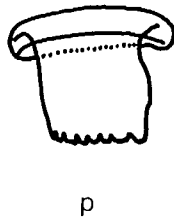

T. nerthus



V. nevadana

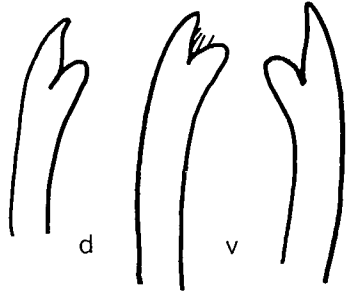

I. frantzi



I. perrieri



TUBIFICIDAE: Group 2 (continued)

(a) Species with short, thin penis sheaths are:

1. No specially modified chaetae, hair chaetae serrate or not, penis sheaths granular, often very thin, separated from other species perhaps more by the absence of distinctive features listed for the others.  
Cosmopolitan, but often found in marginal habitats, often with Limnodrilus hoffmeisteri.  
Tubifex tubifex p.149
2. Hair chaetae strongly serrate and extremely long in contrast to the very long but unusually thin body of the worm. Pectinate chaetae characteristic.  
A rare species, St. Lawrence Great Lakes and Alabama.  
Tubifex ignotus p.149
3. Hair chaetae serrate. Pectinate chaetae characteristic. Limited to coastal habitats in fresh water, Newfoundland to New Brunswick.  
Tubifex nerthus p.149
4. Hair chaetae thin, straight, non-serrate. Pectinate chaetae with a few distinct intermediate spines. Penis sheaths very indistinct.  
Lake Tahoe.  
Varichaetadrilus nevadana p.177
5. Hair chaetae may begin in II, but often do not begin until V or beyond, hair chaetae bent. Pectinate chaetae rare, usually only bifids. Penis sheaths truncated cones.  
Pacific coast estuaries, fresh and slightly brackish water, Washington and British Columbia.  
Ilyodrilus frantzi p.173
6. Hair chaetae non-serrate. Pectinate chaetae with parallel teeth. Penis sheaths truncated cones, very thin.  
California, ?British Columbia.  
Ilyodrilus perrieri p.171

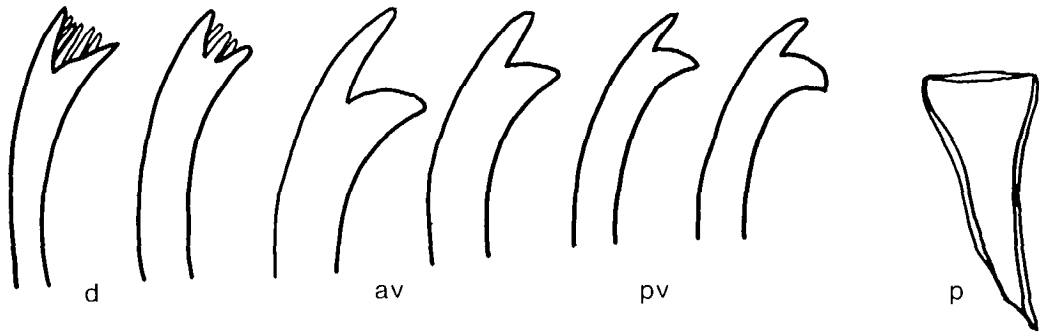

*I. templetoni*

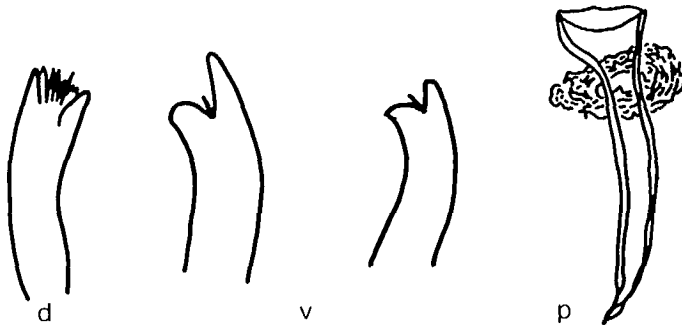

*T. kessleri*



*T. superiorenensis*

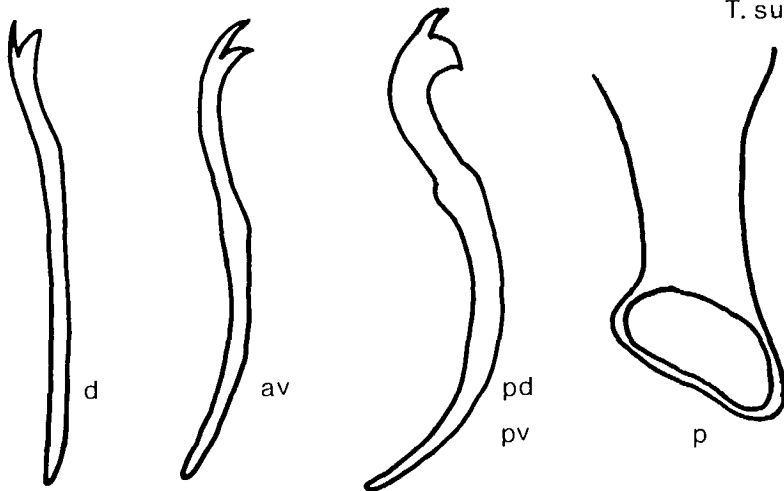

*T. harmani*

TUBIFICIDAE: Group 2 (continued)

(b) Species with conical or elongate penis sheaths are:

1. Penis sheaths broadly conical, sometimes retaining a distal portion beyond the normal distal end. I. templetoni is often confused with T. tubifex but in the former species the most anterior ventral chaetae have upper teeth distinctly longer than the lower.  
Very widespread and common.  

Ilyodrilus templetoni p.171
2. Penis sheaths narrowly conical with a wide proximal flare and sub-terminal opening.  
Widespread, usually in colder and northern localities.  

Tasserkidrilus kessleri p.151
3. Penis sheaths cylindrical or slightly conical with a proximal flare and a terminal opening.  
St. Lawrence Great Lakes and Wisconsin, cold water.  

Tasserkidrilus superiorenis p.151
4. Penis sheaths narrowed medially, distal opening ventro-lateral. Posterior chaetae (dorsals and ventrals) thick, strongly curved, with large lower teeth. Often asexual.  
Widespread, rare.  

Tasserkidrilus harmani p.151

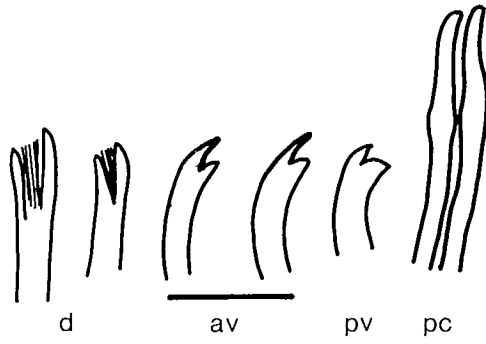

*R. sodalis*

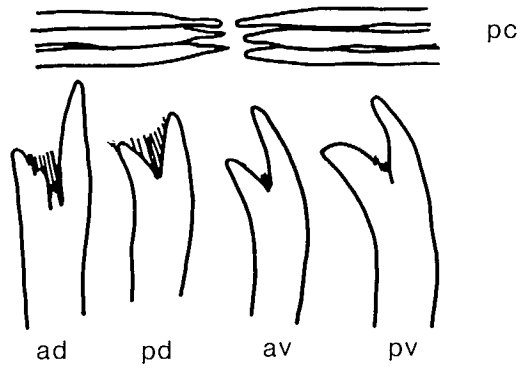

*R. montana*

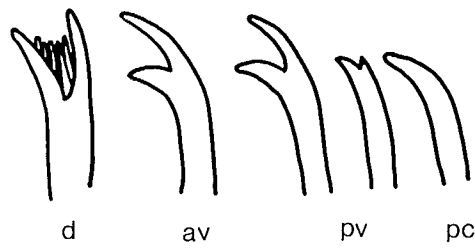

*R. coccineus*

TUBIFICIDAE: Group 2 (continued)

Section C  
(from page 115)

In these species penial chaetae replace the normal ventrals on XI; there are usually several chaetae per bundle, clearly or rudimentarily bifid, with short distal ends, most often arranged in a fan-shaped bundle with the heads grouped together.

1. Pectinate chaetae with long, parallel lateral teeth and very fine intermediate teeth. No elongate hair chaetae. Anterior ventral chaetae up to 6 per bundle, the upper tooth longer and thinner than the lower. Widespread but rare.

Rhyacodrilus sodalis p.197

2. Pectinate chaetae with the upper tooth distinctly longer than the lower anteriorly. Hair chaetae of II often elongate. Anterior ventral chaetae up to 6 per bundle, the upper tooth 1.5 times the length of the equally thick lower tooth.

Across Canada plus the St. Lawrence Great Lakes basin.

Rhyacodrilus montana p.197

3. Pectinate chaetae with short, equally long teeth and distinct intermediate teeth. No elongate hair chaetae. Anterior ventral chaetae up to 9 per bundle with the upper teeth a little longer and thinner than the lower.

St. Lawrence Great Lakes, Wisconsin, across Canada, probably widespread in northern and upland sites.

Rhyacodrilus coccineus p.197

See also note concerning R. punctatus (page 209).

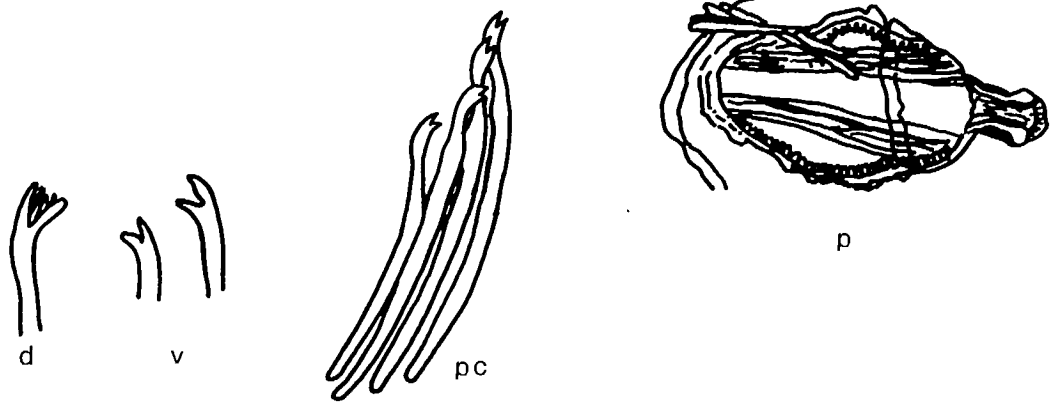

*V. pacificus*

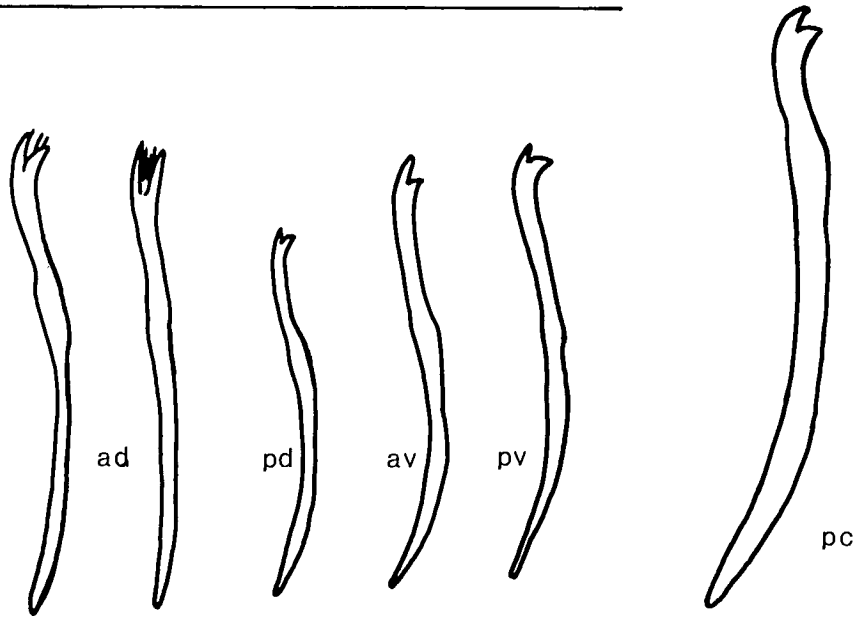

*V. minutus*

TUBIFICIDAE: Group 2 (continued)

Section D  
(from page 115)

In this group there are only slightly modified penial chaetae in XI, and the penis sheaths are thin.

1. Penial chaetae 3-4 bifid chaetae slightly wider than normal. Large erectile penes with short penis sheaths distally. Up to 8 pectinate and 10 hair chaetae per bundle dorsally.  
Alaska to Washington, cold water - one form lacks hair and pectinate chaetae.

Varichaetadrilus pacificus p.177

2. Penial chaetae large, short distally, wide (148 x 8 um), clearly bifid, 3-4 per bundle. Thin conical penis sheaths present. Up to 5 hairs and 5 pectinate chaetae dorsally.  
Lake Tahoe and Alberta.

Varichaetadrilus minutus p.179

Now that V. minutus has been recognized as a member of this genus (Brinkhurst 1985), the distinction between V. pacificus and V. minutus needs to be re-examined.



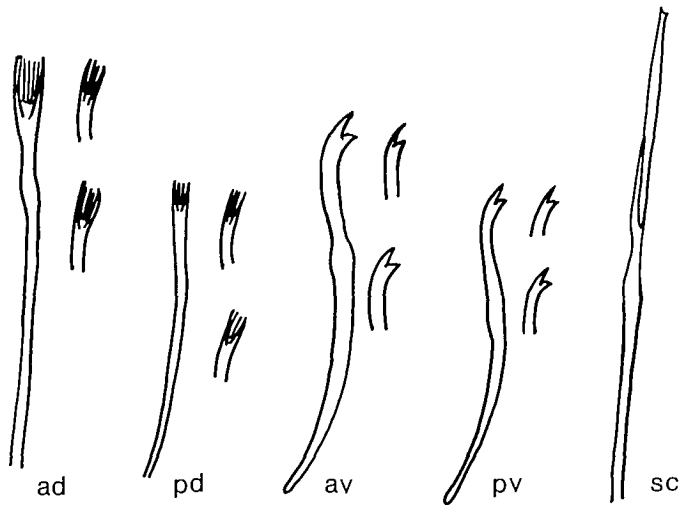

*P. californianus*

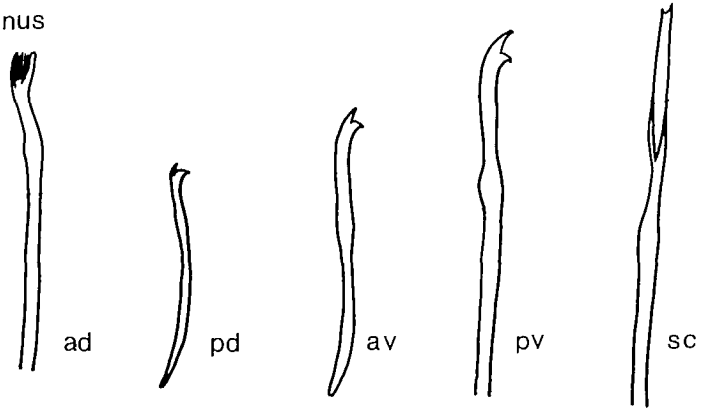

*P. convolutus*



*P. bavaricus*

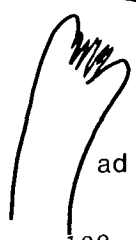

*P. hammoniensis*

pectinate ventral

TUBIFICIDAE: Group 2 (continued)

Section E  
(from page 115)

These species have hair and pectinate chaetae dorsally and modified spermathecal chaetae ventrally on X, usually an enlarged, hollow tipped single chaeta on each side. Very rare specimens have additional spermathecal chaetae on IX.

1. Pectinate chaetae slightly palmate with relatively long parallel teeth. Spermathecal chaetae slender, 117-125 um long. Thin cuticular penis sheaths slightly longer than broad.  
California, St. Lawrence Great Lakes basin, Illinois, British Columbia.  
Psammoryctides californianus p.155
2. Pectinate chaetae with thin parallel teeth and a series of fine intermediate teeth. Spermathecal chaetae quite slender, 84-105 um long. Short cuticular penis sheaths slightly longer than broad.  
Gulf Coast swamps, Florida to Mexico.  
Psammoryctides convolutus p.155
3. Pectinate chaetae with teeth relatively short, diverging. Spermathecal chaetae, when fully developed in mated specimens, with broad, spear shaped tips, 108-180 um long\*. Penes naked.  
Uncommon but widely distributed.  
Potamotheix bavaricus p.159
4. Pectinate chaetae with teeth relatively short, diverging. Spermathecal chaetae when fully developed large, wide, parallel sided with a trough like depression on the wide, distal end, 220-250 um long\*. Penes naked.  
No certain records; mostly uncertain partially mature specimens from a wide range of localities from Florida to the St. Lawrence Great Lakes.  
Potamotheix hammoniensis p.159

The penis sheaths in Psammoryctides are frequently crumpled. They may represent the lining of eversible penes (see page 154).

\*The shape of the spermathecal chaetae may vary with the degree of maturity of the specimen.

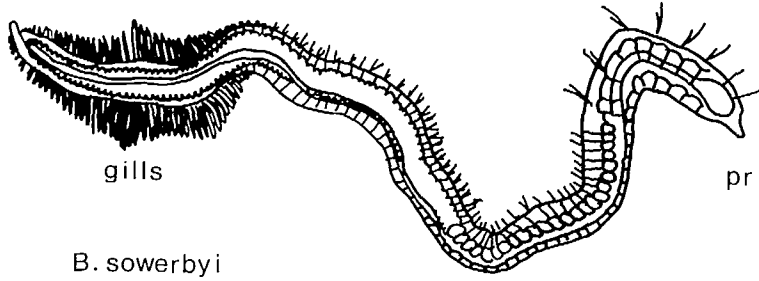

gills

pr

*B. sowerbyi*

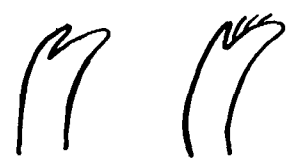

chaetae

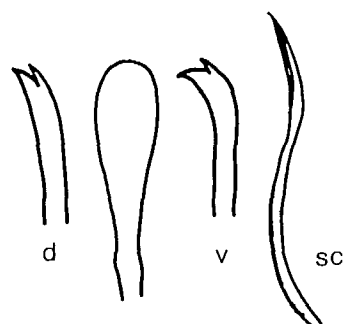

oar

*A. pigueti*

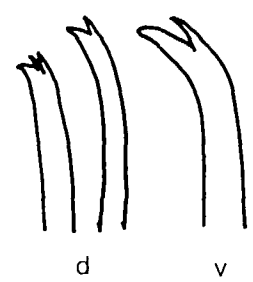

*A. plurisetia*

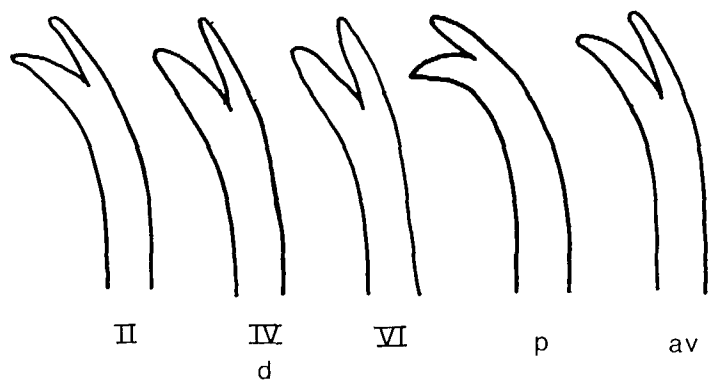

*P. vejnovskyi*

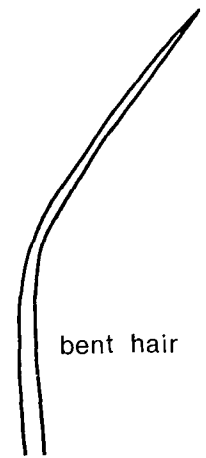

bent hair

## TUBIFICIDAE

### Group 3 (from page 111)

This group of species has hair chaetae (usually very short) accompanied by either bifid chaetae or chaetae with the upper teeth replicated. Specific differences tend to be clear. Two sections can be identified:

1. Ventral chaetae up to 12 per bundle,  
upper teeth shorter and thinner  
than the lower. Section A below
2. Ventral chaetae up to 5 per bundle,  
upper teeth as long as or longer  
than the lower or, if shorter,  
accompanied by simple pointed  
chaetae. Section B p.133

#### Section A

1. Large worms with posterior gills. Specimens lacking a rear end could be mistaken for A. pluriseta. Dorsal chaetae may be pectinate.  
Widespread. Branchiura sowerbyi p.205
2. Small worms with hair chaetae often beginning behind II (in VI or VIII), bifid chaetae change to oar shaped chaetae at about VII, spoon shaped spermathecal chaetae present in rare specimens.  
Widespread. Aulodrilus pigueti p.191
3. Dorsal bundles with up to 8 short hair chaetae and up to 10 bifid chaetae with short thin upper teeth that may be duplicated; ventral chaetae up to 16 per bundle with very short thin upper teeth.  
Widespread. Aulodrilus pluriseta p.191
4. Hair chaetae characteristically bent, bifid chaetae with both teeth somewhat ovoid or lance shaped, up to 10 ventral chaetae per bundle replaced by large single spermathecal chaetae on each side of X.  
St. Lawrence Great Lakes basin, Virginia, Ohio.  
Potamothrix vej dovskyi p.157

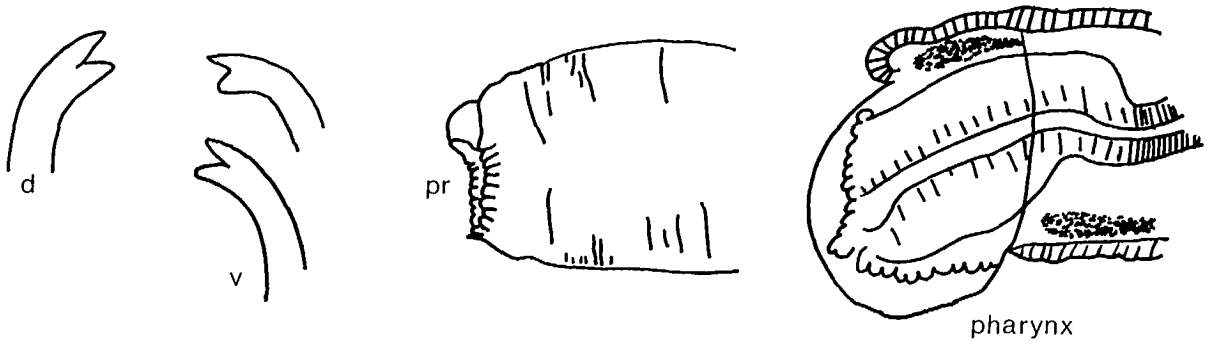

T. mastix

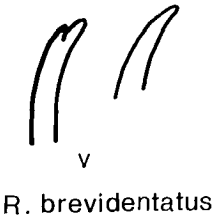

R. brevidentatus

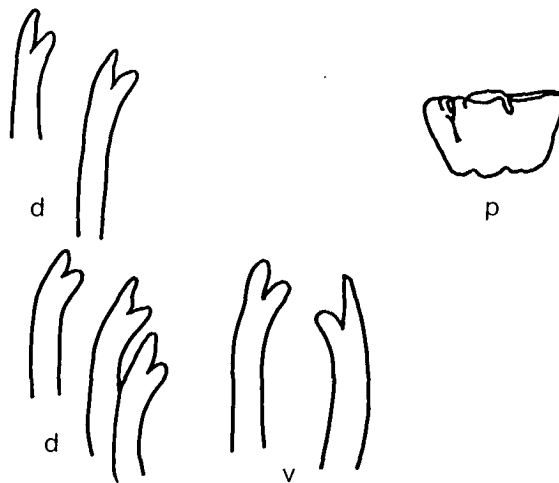

I. frantzi

TUBIFICIDAE: Group 3 (continued)

Section B  
(from page 131)

1. Worms with small prostomium but very large pharynx (?predatory). Chaetae of III (or III and IV) often missing. Dorsal and ventral chaetae of II single, with short thin upper teeth; from IV dorsal bundles with 2-3(5) short hair chaetae and 2-3 bifids with thin upper teeth. Other ventral bundles 2-4(5) chaetae with upper teeth slightly longer and thinner than the lower. No genital chaetae or penis sheaths, no spermathecae. Estuarine, freshwater, Pacific coast of British Columbia, Oregon.  
Teneridrillus mastix p.175
2. Dorsal bundles with 1-2 hair chaetae anteriorly, 2-3 bifids with upper tooth shorter and thinner than the lower; ventral chaetae up to 4 similar chaetae, or some simple pointed. Male pores in a median depression, genital chaetae not reported. Lake Tahoe.  
Rhyacodrillus brevidentatus p.199
3. Hair chaetae begin in V or beyond, 2-3 short, bent chaetae per bundle. Bifid chaetae from II, 4-7 per bundle, upper teeth longer than the lower. Penis sheaths conical. No genital chaetae. West coast estuaries.  
Ilyodrillus frantzi p.173

Rare examples of T. tubifex and I. templetoni that lack pectinate dorsal chaetae will key out here.



*S. beetoni*

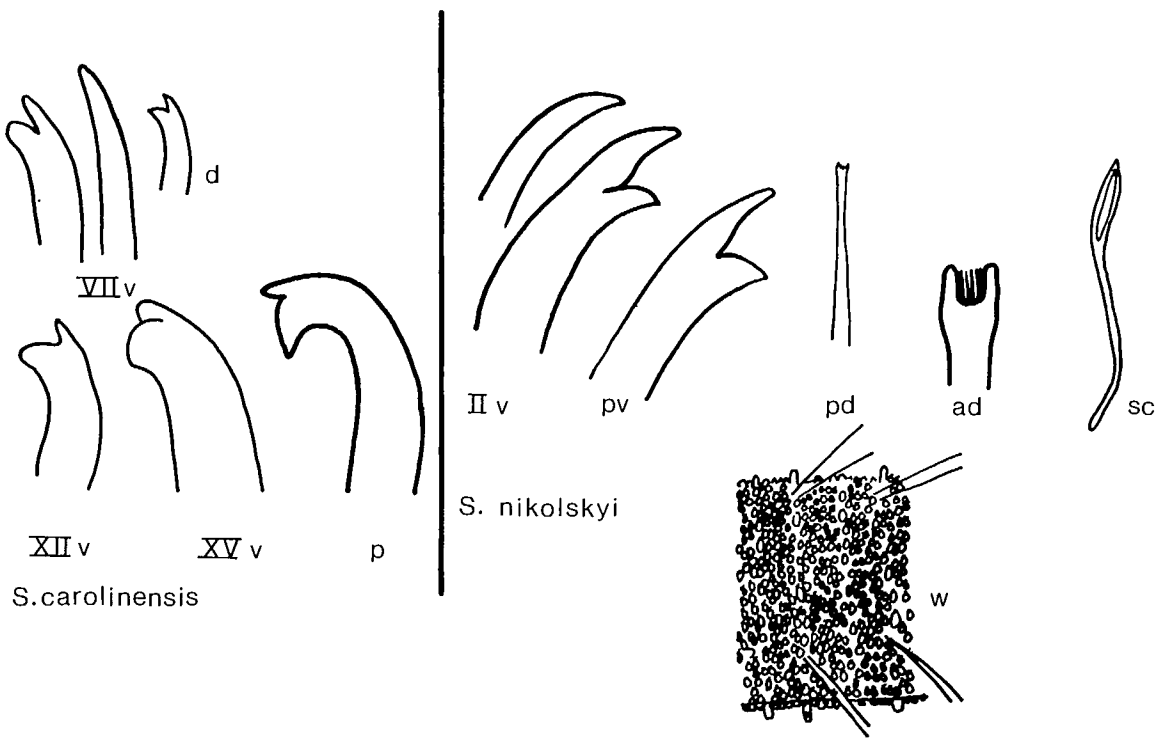

*S. nikolskyi*

*S. carolinensis*

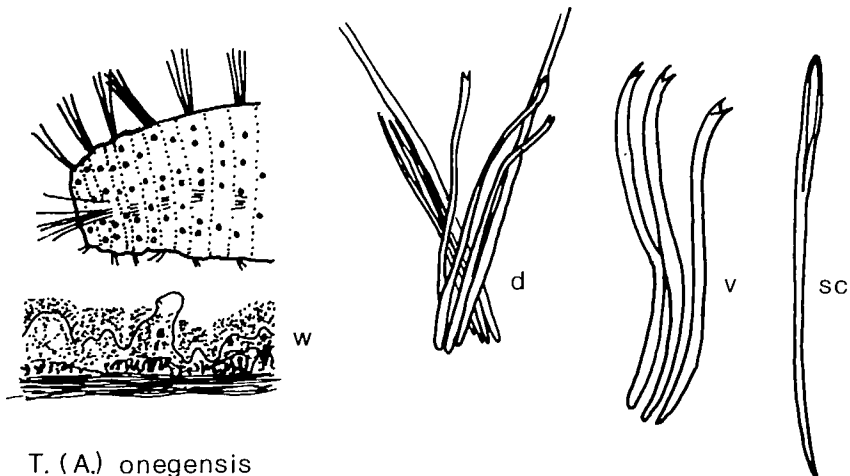

*T. (A.) onegensis*

## TUBIFICIDAE

### GROUP 4 (from page 111)

These four papillate species have hair chaetae accompanied by thin, hair-like chaetae that are hard to see.

1. Body wall clearly papillate. Dorsal chaetae 2-3 hairs and 1-2 broadly pectinate or bifid chaetae. Anterior ventral chaetae 2 per bundle either one with the upper tooth longer than the lower, the other with teeth equally long, or both worn down until one is simple pointed; median and posterior chaetae with short to rudimentary upper teeth.  
Lake Tahoe.

Spirosperma beetoni p.187

2. Body wall clearly papillate, but papillae well separated. From II-VIII or IX ventral chaetae paired, 1 bifid, 1 simple pointed; from XIII ventral chaetae single, strongly modified. Penis sheaths very thin.  
White Lake and Waccama Lake, Carolina Bay Lakes, North Carolina.

Spirosperma carolinensis p.185

3. Body wall variable, at most a dense papillation plus a ring of large papillae on each segment. Up to 6 hair chaetae and a similar number of narrow pectinate chaetae. Ventral chaetae of II-III 2-3 bifids plus 2-3 simple pointed chaetae; the other ventral chaetae with the upper tooth thinner and longer than the lower. Spermathecal chaetae modified. Penis sheaths thin.

Widespread.

In Western specimens the ventral chaetae have shorter upper teeth, and these may be separable as S. oregonensis Br.

Spirosperma nikolskyi p.185

4. Body wall covered in foreign matter, sometimes only thinly on preclitellar segments, with two rows of sensory papillae per segment. Dorsal bundles with 3-6 long hair chaetae, accompanied by short hair-like chaetae with small bifid tips that are inconspicuous and often hidden by the foreign matter. Spermathecal chaetae long, single, hollow tipped.  
Alaska.

Telmatodrilus (Alexandrovina)  
onegensis p.195



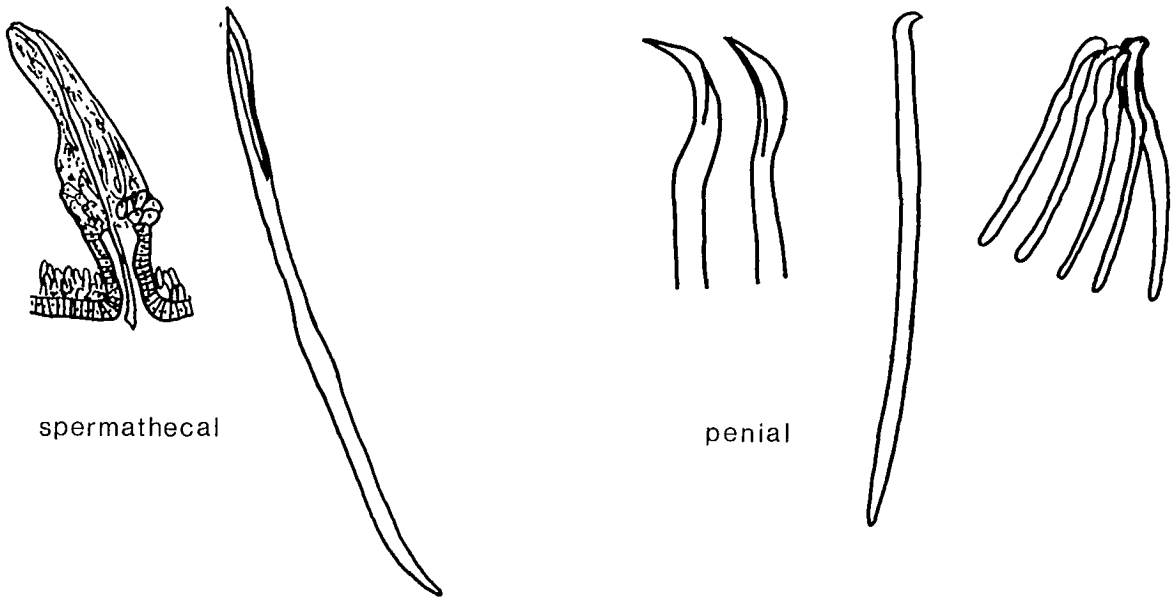

spermathecal

penial

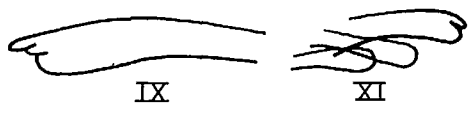

IX

XI

genital  
R. lacteus

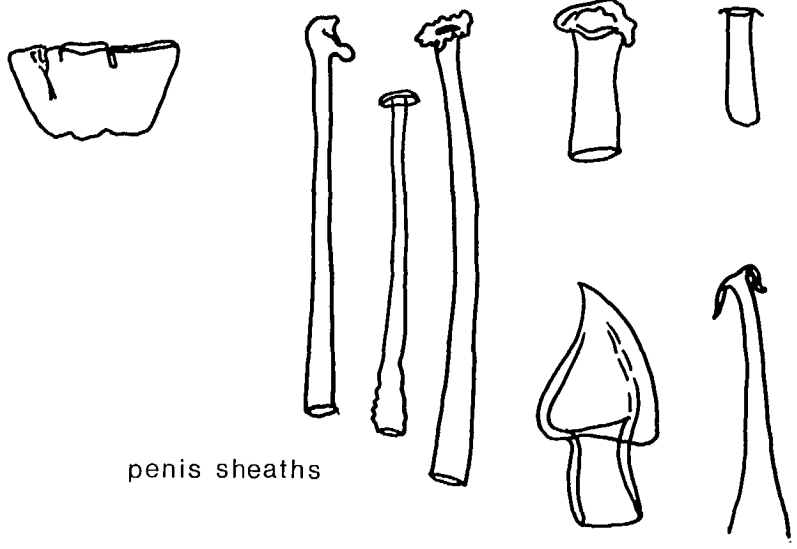

penis sheaths

TUBIFICIDAE

GROUP 5  
(from page 111)

Species with no hair and pectinate chaetae, all dorsal chaetae bifid or simple pointed anteriorly and:

1. Modified spermathecal chaetae on X. Section A p.139
2. Modified penial chaetae on XI. Section B p.141
3. Modified genital chaetae on IX, (single large chaetae replacing the ventrals), and also on XI where 4-5 knobbed chaetae are found in each bundle. Rhizodrilus lacteus p.203
4. No modified genital chaetae in mature specimens, cuticular penis sheaths present. Somatic chaetae all ordinary bifids. Section C p.143
5. No modified genital chaetae in mature specimens, cuticular penis sheaths absent. Somatic chaetae distinctive (page 144). Section D p.145

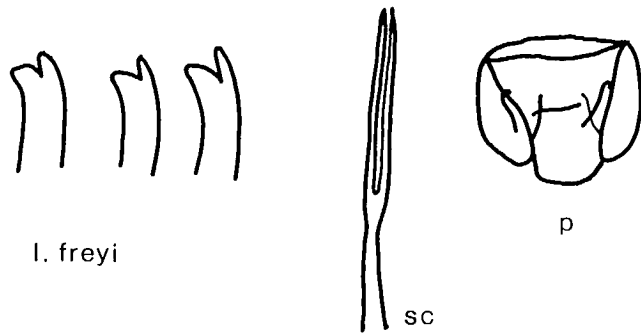

I. freyi

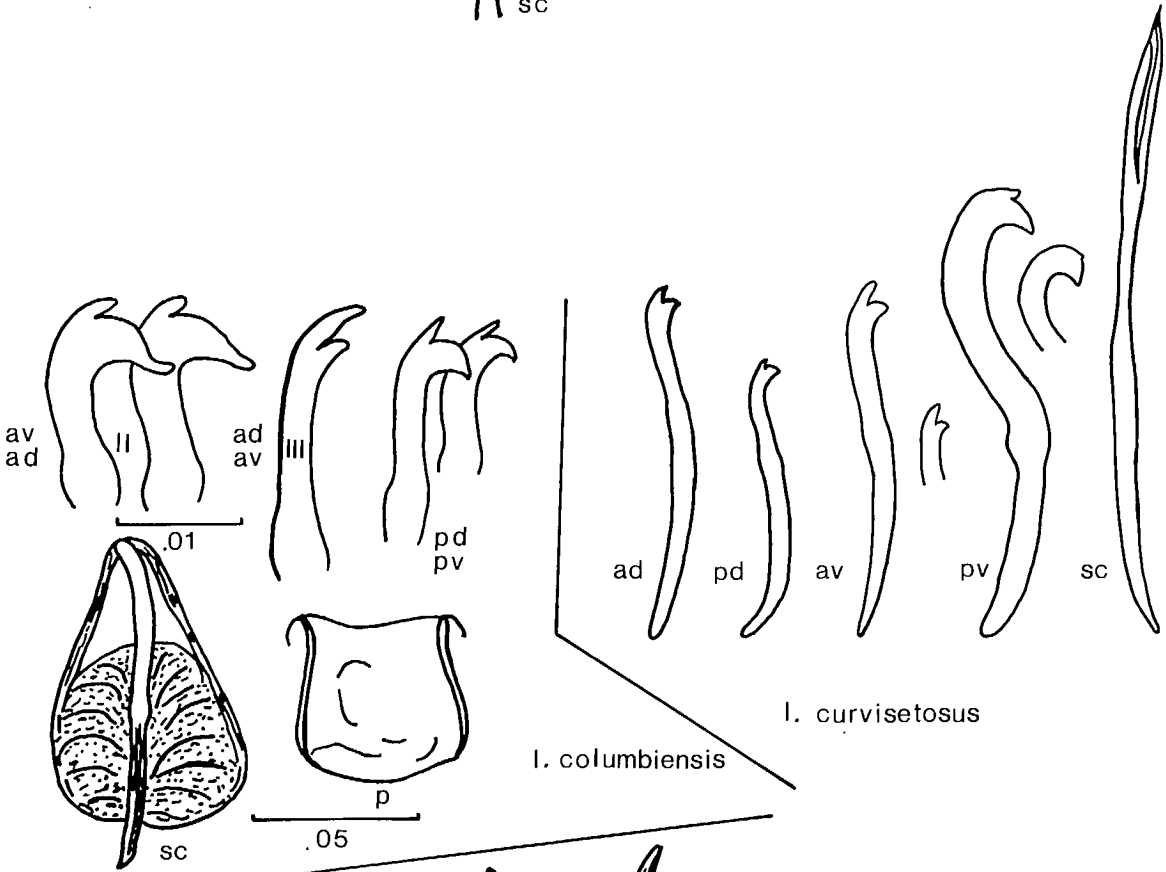

I. curvisetosus

I. columbiensis

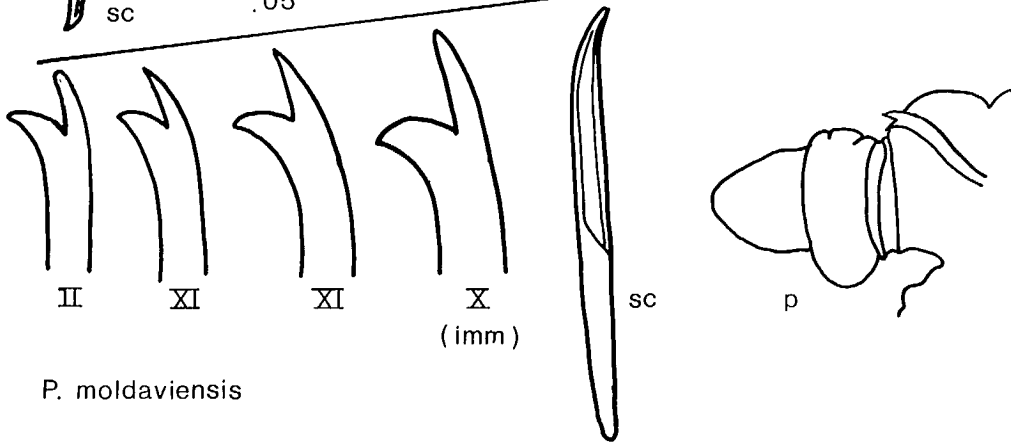

P. moldaviensis

TUBIFICIDAE: Group 5(continued)

Section A  
(from page 137)

This group includes species with no hair chaetae dorsally, all dorsal chaetae being bifid, and modified spermathecal chaetae on X.

1. Spermathecal chaetae long, thin, parallel sided. Cuticular penis sheaths present, broadly conical with large reflected proximal hood.  
Widespread.  

Isochaetides freyi p.153
2. Spermathecal chaetae long, thin, parallel sided. Cuticular penis sheaths present but thin. Posterior ventral chaetae solitary, thick and strongly curved with a very thick, recurved lower tooth.  
Widespread in small rocky streams.  

Isochaetides curvisetosus  
(Isochaetides hamatus sp.dub.) p.153
3. Spermathecal chaetae large, robust. Penes usually everted, lacking penis sheaths, associated with retained but very slightly modified ventral chaetae.  
St. Lawrence Great Lakes basin.  

Potamothrix moldaviensis p.157
4. Spermathecal chaetae long, thin, parallel sided. Cuticular penis sheaths thin, almost as wide as long. Anterior ventral chaetae of II with huge lower teeth, those of III with long upper teeth, posterior ventral chaetae with short upper teeth.  
Columbia River, Oregon.  

Isochaetides columbiensis p.153

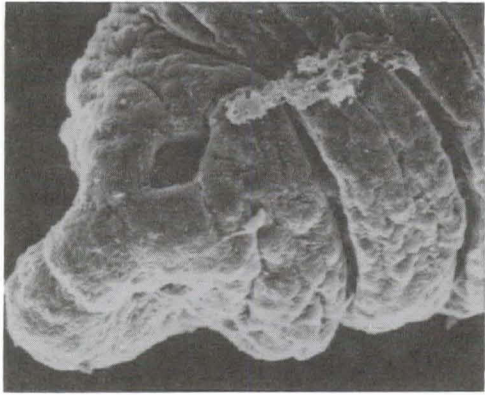

prostomial pit



spermatophores



chaeta

*B. vejdoskyanum*

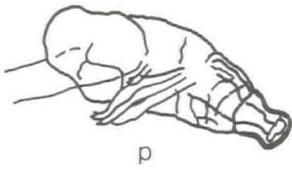

p

*V. pacificus*



pc



sz

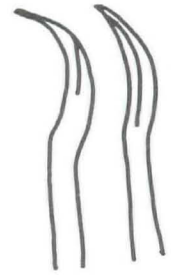

pc

*R. falciformis*



pc

p

a

*P. hallae*

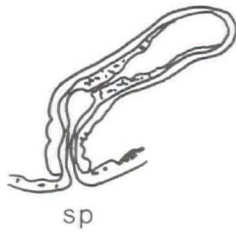

sp

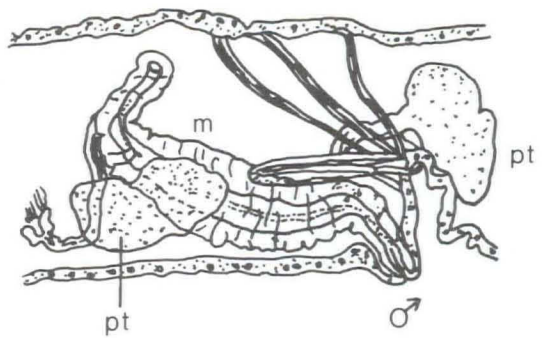

pt

♂

## TUBIFICIDAE

### Section B (from page 137)

This group includes species with no hair chaetae dorsally, all dorsal chaetae being bifid, and modified penial chaetae on XI (see page 137).

1. Sensory pit in the prostomium. Spermathecae absent, mated specimens with spermatophores attached externally. Male pores open into a median ventral pit. Several penial chaetae in each bundle, short distally with inflated knob or hook-shaped tips bunched together.  
Widespread in sand.  

Bothrioneurum vej dovskyanum p.201
2. No sensory pit. Spermathecae present with spermatozeugmata. Several penial chaetae in each bundle, short distally but clearly bifid. Large eversible penes bear short distal cuticular sheaths.  
This form limited to Columbia River estuary, Oregon.  

Varichaetadrilus pacificus (bifidus) p.177
3. No sensory pit. Spermathecae present, with loosely bundled sperm. Penial chaetae single, large sickle shaped on each ventral side of XI. No penes.  
New York, British Columbia.  

Rhyacodrilus falciformis p.199
4. No sensory pit. Spermathecae present, with sperm in random masses. Penial chaetae 3-6 hooked, simple pointed. Dorsal chaetae simple pointed from XXIII on. No penes, male pores on porophores.  
Lakes Huron, Superior.  

Phalldrillus hallae p.207



p

*I. frantzi*



sz

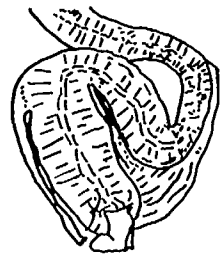

p

*V. fulleri*

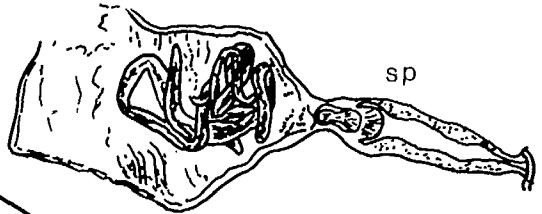

sp

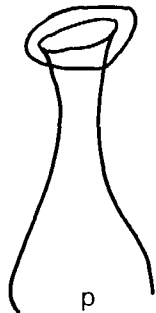
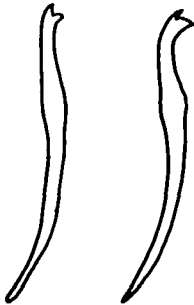

p

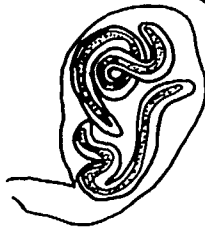

sz

*V. psammophilus*

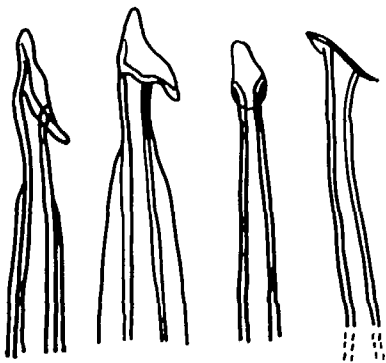

*Limnodrilus* species

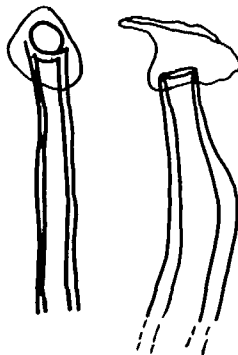

p

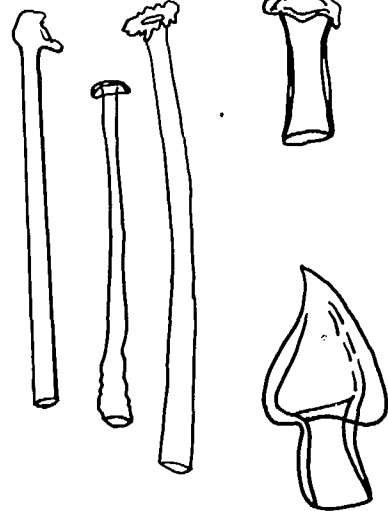

TUBIFICIDAE: Group 5 (continued)

Section C  
(from page 137)

The species of this group are characterized by the presence of cuticular penis sheaths. All dorsal chaetae are bifid and no genital or hair chaetae are present.

1. Cuticular penis sheaths broad truncated cones. Spermatozeugmata with broad head and narrow tail.  
Pacific coast estuaries, freshwater.  
Ilyodrilus frantzi p.175
2. Short cuticular penis sheaths on ends of large erectile penes.  
Spermatozeugmata vermiform.  
Kentucky, lower Mississippi River.  
Varichaetadrilus fulleri  
V. psammophilus p.177
3. Cuticular penis sheaths cylindrical, surrounded by spiral muscles.  
Spermatozeugmata mostly short, lanceolate.  
Limnodrilus (10 species) p.161



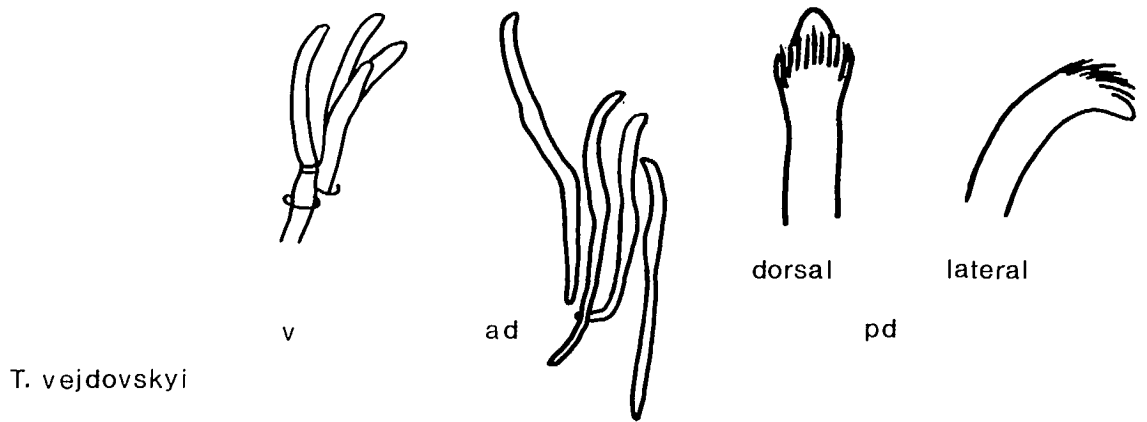
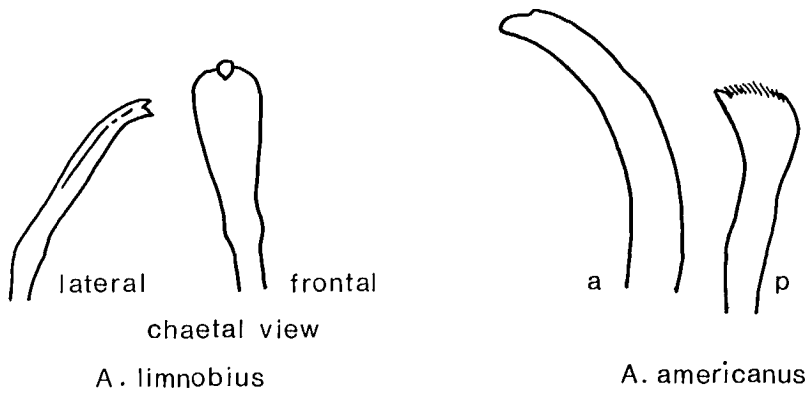
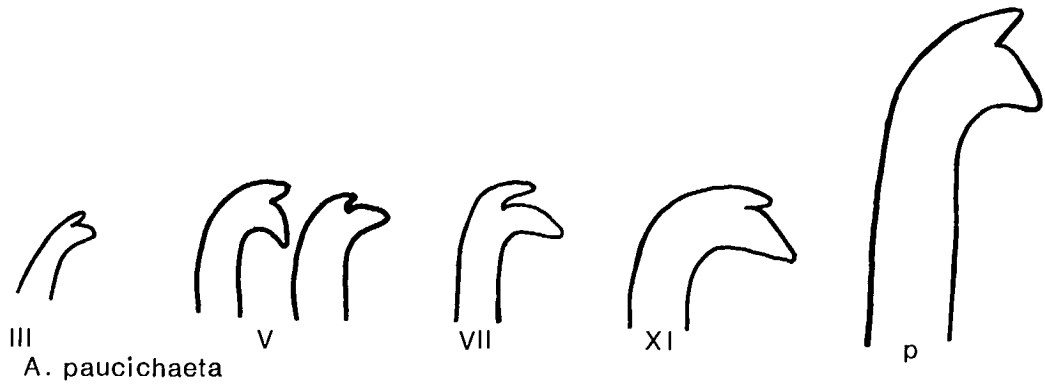

TUBIFICIDAE: Group 5 (continued)

Section D  
(from page 137)

These four species do not possess hair chaetae, genital chaetae, or cuticular penis sheaths.

1. Up to 10 chaetae per bundle anteriorly, all bifid with the upper tooth shorter and thinner than the lower; in face-on view, flat lateral expansions of the chaetae are visible, with the teeth appearing as a median tooth.  
Widespread.  

Aulodrilus limnobius p.191
2. Up to 10 chaetae per bundle anteriorly, at first more or less simple pointed or with rudimentary tooth or teeth, from VI onwards chaetae broadly palmate, up to 8 per bundle. Worms usually in tubes.  
Widespread in Canada, St. Lawrence Great Lakes, Eastern United states.  

Aulodrilus americanus p.193
3. Up to 14 chaetae per bundle anteriorly, simple pointed; from the clitellum on, the chaetae have multiple upper teeth forming brush-like tips.  
Semi-terrestrial, California, British Columbia.  

Telmatodrilus vej dovskyi p.195
4. Only 2-3 chaetae per bundle anteriorly, bifid with the upper tooth shorter and thinner than the lower. Chaetae enlarge progressively to IX, no chaetae on X and XI in mature specimens, post-clitellar segments with 4 identical chaetae per segment (solitary in each bundle), somewhat recurved with thick lower teeth.  
Maryland, North Carolina.  

Aulodrilus paucichaeta p.193



TUBIFEX Lamarck, 1816; TASSERKIDRILUS Holmquist, 1985

It has been clear for some time that this genus was not a monophyletic group, and the division here reflects that. The Tubifex species have the typical thin, tub-shaped penis sheaths\* of the type species. These are so thin that Holmquist (1983) does not regard them as penis sheaths but they are visible in cleared whole mounts as distinctive structures separable from the body wall cuticle. Three species in Tasserkidrilus have elongate penis sheaths.

A partial revision of Tubifex by Holmquist (1985) has formalized the separation of the T. kessleri group from the typical Tubifex group, but in other respects is disappointing. An array of species currently attributed to a number of genera are considered in groupings that lead to unusual comparisons. While previous studies are severely criticized for lack of detail, this account based on histological studies omits the classical presentation of features such as chaetae and penis sheaths. The illustrations of atria may be accurate reconstructions of specific individuals but are not accompanied by diagnostic representations of the atrial form that clarifies spatial relationships of parts in some instances.

New Alaskan species and even genera (Kopilrok flexipenis, K. sagavanirktoki) seem barely separable from Tubifex tubifex from the descriptions, which is also true of T. fissidens Holmquist, 1983 from Illinois. Even Holmquist remarks that fissidens resembles T. tubifex ("It would be easy to dismiss the Urbana specimens simply as a variety of T. tubifex. There is no single, clear-cut, striking character to refute such a suggestion") and that K. sagavanirktoki is poorly known ("The three single specimens from Sagavanirktok lake and lake 19 of the Alaska survey appear to belong to another species but the condition of the small material does not provide acceptable proof of this. Tentatively, I establish a new species... The differences are of the same degree as the corresponding differences between the species T. tubifex and T. fissidens").

The specimens of I. perrieri described by Holmquist from Illinois are not from the type locality (which she uses elsewhere to justify excluding published descriptions from consideration) and are clearly I. templetoni. Lophochaeta paucipilifer Holmquist, 1985 is at least closely related to T. ignotus.

\* Holmquist retains penis sheath for structures within which the soft penis is free of the sheath walls.

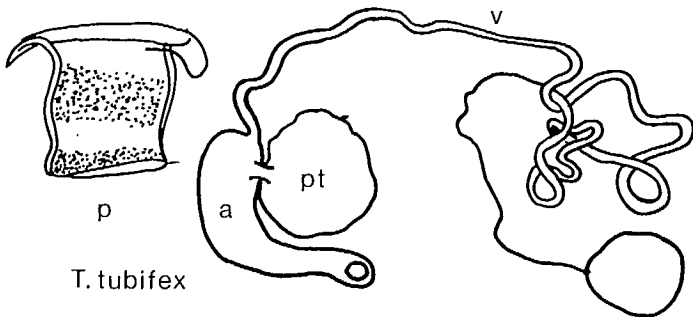
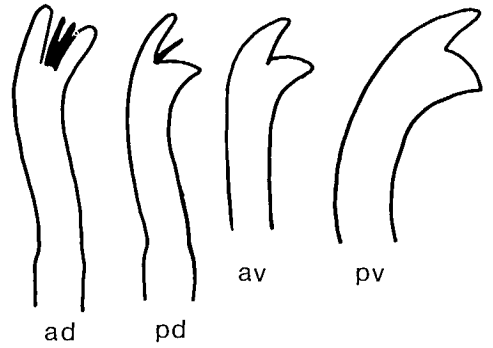
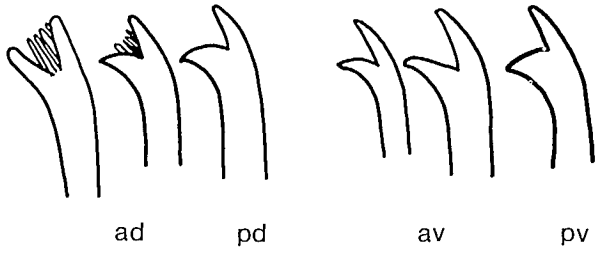

*T. tubifex*

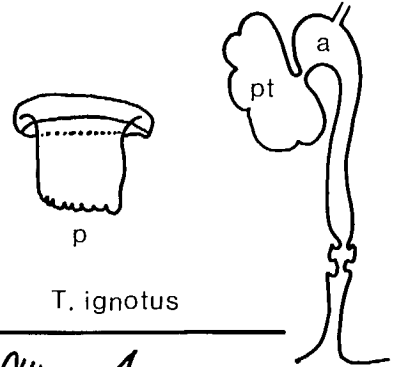

*T. ignotus*

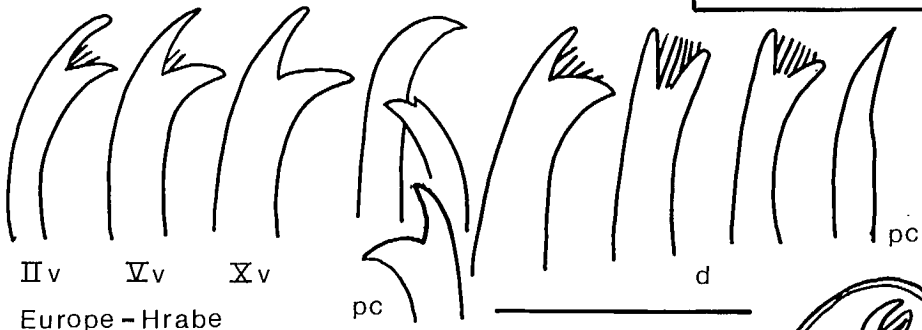

Europe - Hrabe

0.2

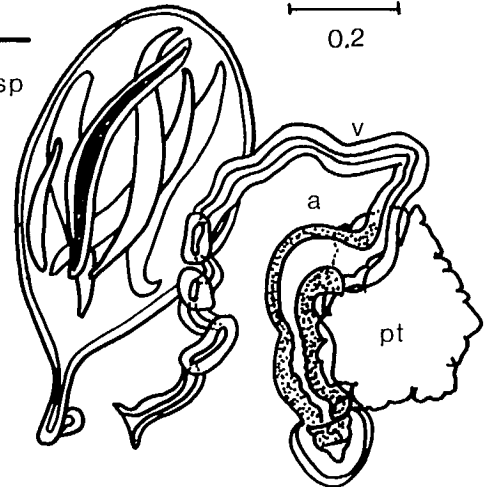
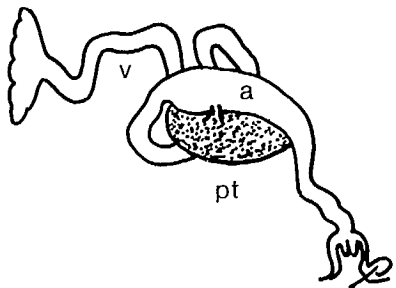

.025

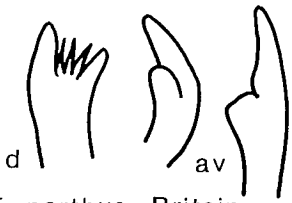

*T. nerthus* - Britain



TUBIFEX Lamarck, 1816

T. ignotus is a very thin worm with remarkably long hair chaetae. T. nerthus has characteristic pectinate chaetae and is usually found in tidal freshwater sections of rivers. T. tubifex has chaetae of a very standard form with no exaggerated features.

1. T. tubifex (Muller, 1774)

Dorsal bundles with 3-5 pectinate chaetae and 1-6 hair chaetae, which may be serrate. Ventral bundles with 3-6 or more chaetae anteriorly, decreasing to 2 posteriorly; the upper tooth thinner than but as long as the lower, sometimes with a small intermediate tooth. All hair and pectinate chaetae may be replaced by bifids or by mildly pectinate chaetae and small sparse hair chaetae (blanchardi, bergi forms), but they have not been seen in North America. The atria are comma shaped with anterior prostate glands. The vasa deferentia are elongate and composed of two sections of different widths. The spermathecae may be paired, single or absent.

Widespread.

This species is not as common as the general texts might suggest. It seems to occupy marginal habitats (oligotrophic lakes, hypereutrophic pools etc.) and perhaps avoids competition in such places.

2. T. ignotus (Stolc, 1886)\*

Very thin elongate worms. Dorsal bundles with 1-3 U-shaped pectinate chaetae and elongate hair chaetae with obvious lateral hairs, or serrations. The ventral bundles have 3-5 chaetae anteriorly, with the upper tooth longer and thinner than the lower, posteriorly only 2 with the upper tooth as long as the lower. Vasa deferentia long, divided into thin and thick portions, entering small, globular atria apically.

Generally scarce, St. Lawrence Great Lakes, Alabama, Oregon.

3. T. nerthus Michaelsen, 1908 (?T. newfei Pickavance & Cook, 1971)

Dorsal bundles with 3-4 U-shaped pectinate chaetae and 1-2 serrate hairs. Ventral bundles with 4 chaetae with the upper tooth twice as long as the lower, the lower being reduced or even absent in XI. The male ducts with the vasa deferentia short and broad. Penis sheaths as broad as long, with strongly ridged walls at least in the form claimed by the author to be a possible synonym, T. newfei, Pickavance & Cook. This rare species needs study. The chaetae as illustrated by Hrabe differ from those from Britain and North America, and from the original accounts.

Newfoundland, New Brunswick, coastal.

\*Similar worms from Alaska with short, non-serrate hairs in preclitellar bundles only are referred to as Lophochaeta (=Tubifex) paucipilifer Holmquist (1985 sp. inq.).

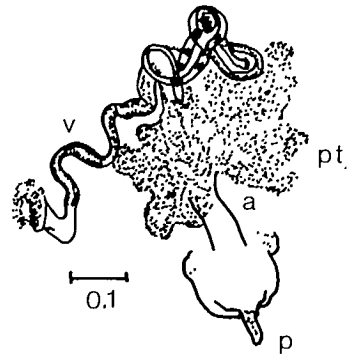
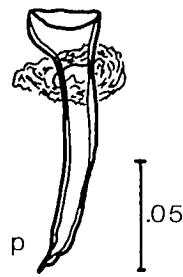
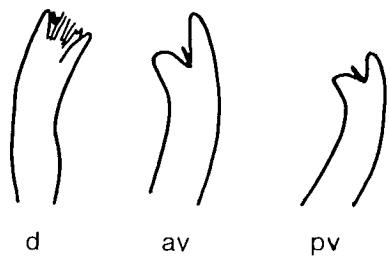

T. kessleri

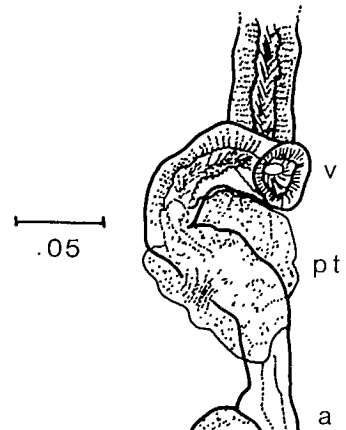
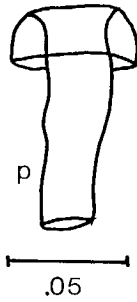
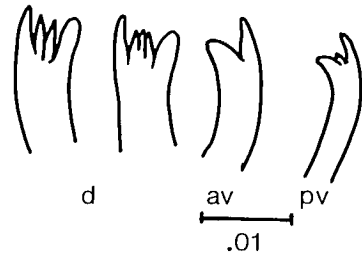

T. superiorenensis

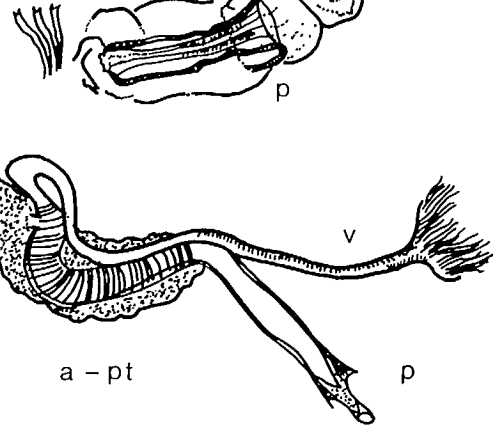
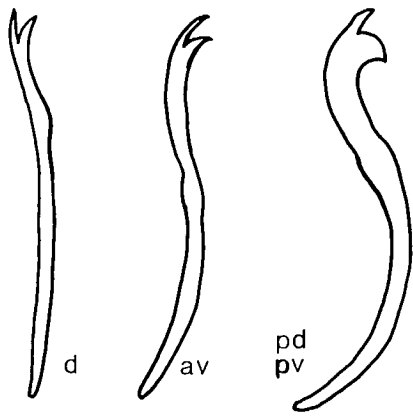

T. harmani

1. T. kessleri (Hrabe, 1962)

Dorsal bundles with 3-4 hair chaetae and 3-4 pectinate chaetae, posteriorly fewer. Ventral bundles with 3-5 bifid chaetae, the upper tooth longer than the lower, which often bears an additional spine. Male ducts have vasa deferentia about three times the length of the atria, which they enter apically. The penis sheaths are conical with lateral openings, and a wide proximal flare.

Widespread in northern localities.

The range of variation in chaetal form is considerable in material from the U.S.S.R., and may be anticipated in North America. Holmquist (1985) refers this North American material to the new species americanus, formerly considered a subspecies.

2. T. superiorenensis (Brinkhurst & Cook, 1966)

Dorsal bundles with 4-5 serrate hairs and about 4 pectinate chaetae with broad lateral teeth and few intermediates. Ventral bundles with 4-6 bifid chaetae with the upper teeth as long as but thinner than the lower often bear intermediate spine. The broad vasa deferentia enter the atria apically, the penis sheaths are cylindrical.

St. Lawrence Great Lakes, Wisconsin, cold water situations.

This species has now been found in the U.S.S.R., in a form lacking hair and pectinate chaetae (Brinkhurst 1984c).

3. T. harmani (Loden, 1979)

Anterior dorsal bundles with 1-3 hair chaetae, finely serrated, and 2-3 pectinate chaetae, posterior dorsal bundles with 1-2 hairs and 1-3 strongly sigmoid chaetae, with the upper tooth shorter and much thinner than the recurved lower tooth. Anterior ventral chaetae 3-5 per bundle, the upper tooth longer and thinner than the lower in II, equal or shorter than the lower in II-X; posteriorly the ventral bifids resemble the posterior dorsal chaetae with a strongly recurved lower tooth. Vasa deferentia about as long as the atria plus the ejaculatory ducts (the distal part of the atrium without muscle bands). Penis sheaths thin, basically conical, cylindrical medially, wide head with opening at an angle to the shaft.

The distribution from Louisiana, Florida, Indiana and British Columbia suggests a widely distributed species, but this is based on chaetal characteristics apart from the Louisiana material. Sexually mature specimens are rare (1%) even in the type locality.



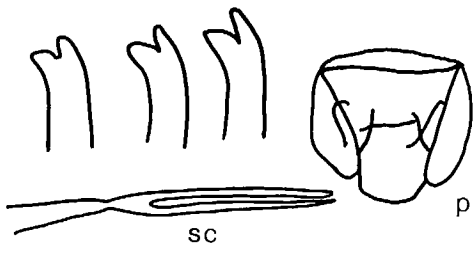

*I. freyi*

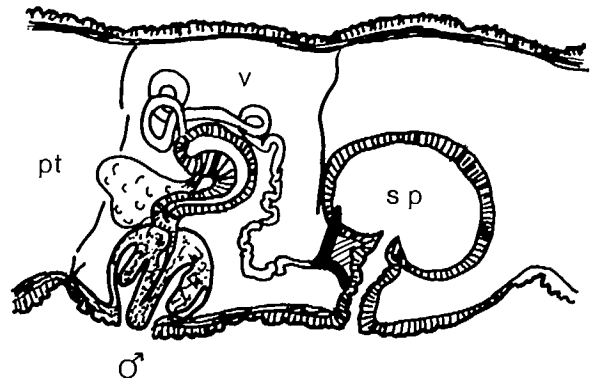

*I. curvisetosus*

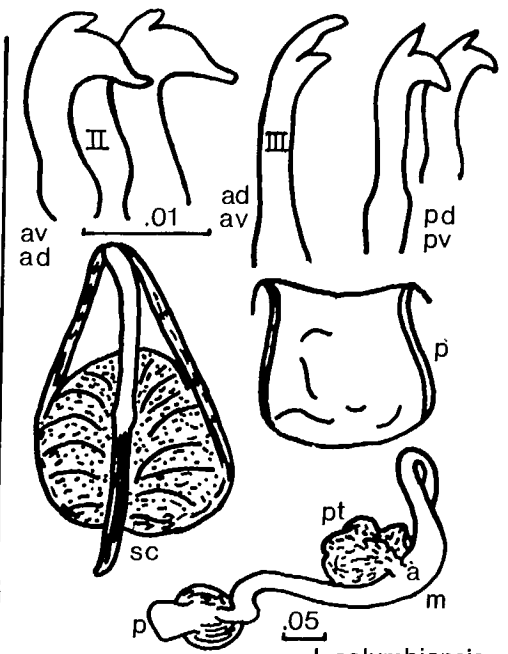
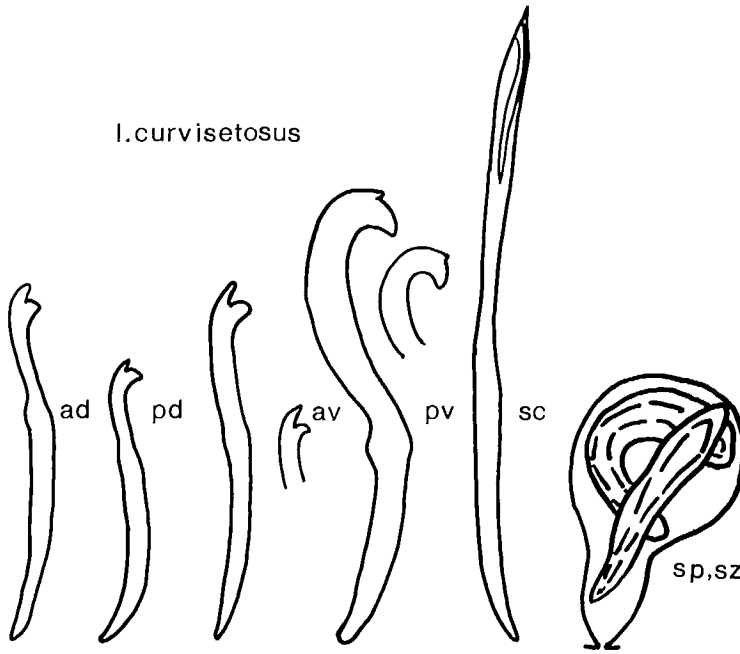

*I. columbiensis*

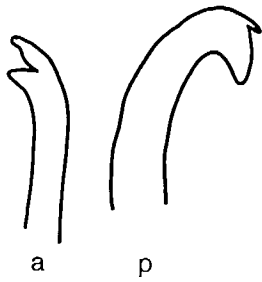

*I. hamatus*

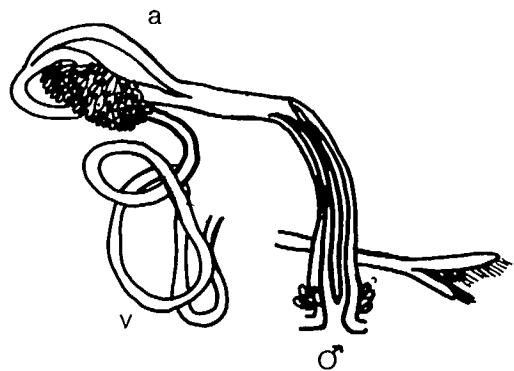

ISOCHAETIDES Hrabe, 1966 emm. Brinkhurst, 1981

While this genus has only recently been revised, a recent redescription of the type species (I. baicalensis) by Brinkhurst (1984) throws considerable suspicion on the monophyletic state of this genus, as the male ducts of I. baicalensis and the three North American species I. freyi, I. curvisetosus and I. columbiensis all differ quite considerably. The chaetal characteristics are more uniform, however, with the narrow spermathecal chaetae in species that also have cuticular penis sheaths.

1. I. freyi (Brinkhurst, 1965)

All chaetae bifid, up to 8 per bundle anteriorly, upper tooth thinner than the lower but equally long, only 2-3 posteriorly. Spermathecal chaetae straight, hollow tipped. Vasa deferentia long, atria strongly curved, penes with thin cuticular sheaths, in sacs with thick walls.

Widespread.

2. I. curvisetosus (Brinkhurst & Cook, 1966) (?=I. hamatus (Moore, 1905))

All chaetae bifid, anterior dorsals and ventrals of II-IX 2-5 with upper tooth as long as or a little longer than the lower; ventrals of II 2-3 with the upper tooth shorter and thinner than the lower. Postclitellar dorsal bundles and ventrals from XI-XXV or so with 2-3 chaetae with a short upper tooth, the ventrals of XXV solitary, thick with short upper teeth and strongly recurved lower tooth. Spermathecal chaetae long, straight, hollow. Vasa deferentia and ejaculatory ducts long, atria small, penis sheaths barely thicker than the cuticle.

Widespread.

There is a strong possibility that this is the same species as I. hamatus (Moore, 1905), which was described from a site in New Bedford, Mass. but has never been seen since. The original description shows penes of considerable length, unlike those of curvisetosus. Surviving material is all immature, with chaetae like those of curvisetosus. M. Loden and T. Wassell (pers. comm.) saw curvisetosus with atria more like hamatus than the type (which may have been stretched in dissection, making the atria and ejaculatory ducts appear to differ more than they do). There remain supposed differences in details of intestine and blood vessels between the description of hamatus and recent specimens of curvisetosus.

3. I. columbiensis Brinkhurst & Diaz, 1985

Chaetae of II 2-4 per bundle with reduced upper teeth and recurved thick lower teeth; those of other anterior segments increase from 2 to 4 and then 6 per bundle with the upper teeth as thick as but much longer than the lower; by VII the teeth approach equal length but in VIII or IX the upper tooth becomes shorter than the lower. Spermathecal chaetae in X. Penes bear short penis sheaths.

Columbia River, Oregon.

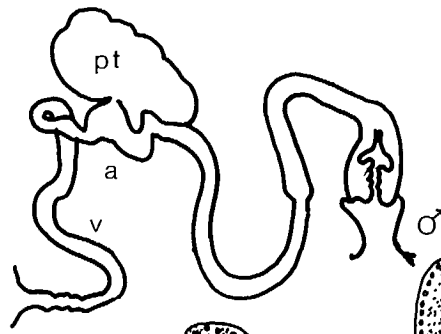
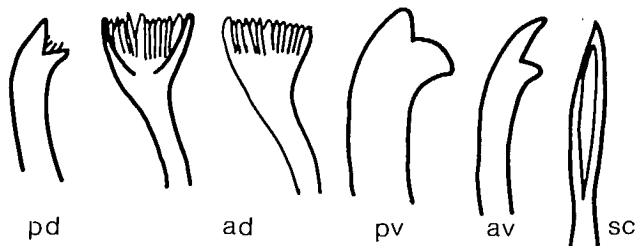

*P. barbatus*

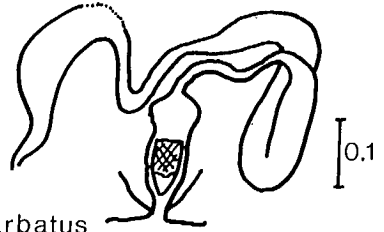
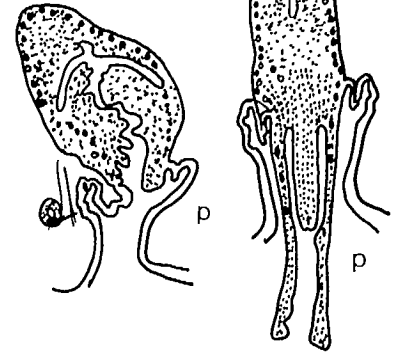
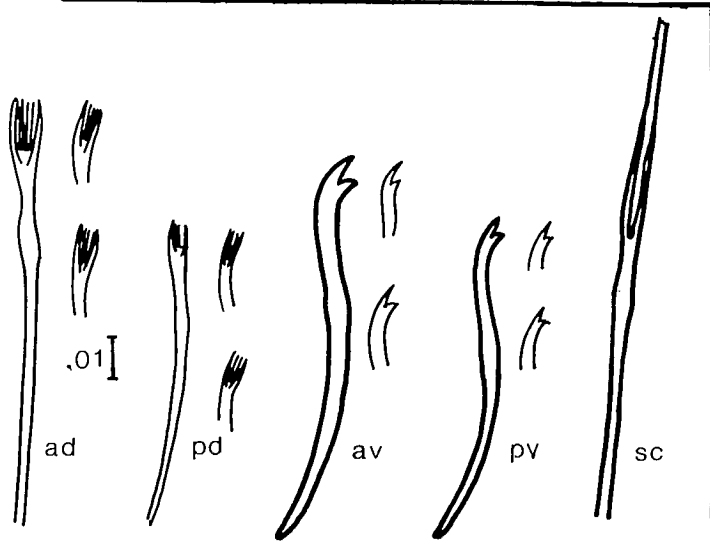

*P. barbatus*

*P. californianus*

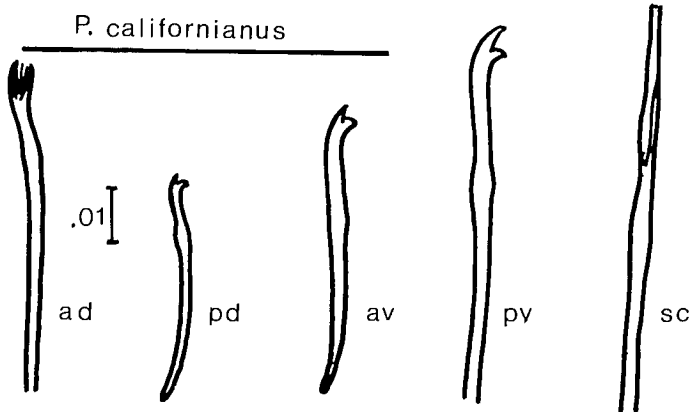

*P. convolutus*

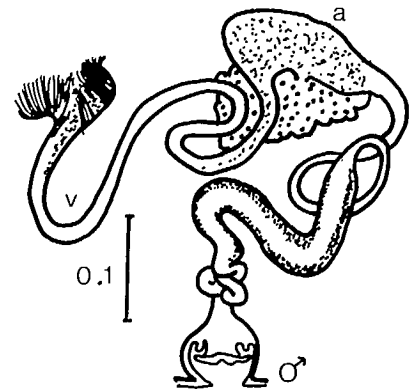

PSAMMORYCTIDES Hrabe, 1964

This genus, like Isochaetides, has thin penial sheaths and modified spermathecal chaetae. One species (P. barbatus) is clearly imported from Europe, and is distinguished from all others in the family by virtue of the broadly palmate chaetae accompanying the hairs dorsally. The chaetae are slightly palmate in P. californianus.

1. P. barbatus (Grube, 1891)

Dorsal anterior bundles with 7-8 broadly palmate chaetae and 2-3 hair chaetae to X, hairs and bifids with short upper teeth from about X rearwards. Ventral bundles with 3-5 chaetae, upper teeth longer and thinner than the lower. Spermathecal chaetae in X, long, thin, hollow. Male ducts with long vasa deferentia, small globular atria, narrow ejaculatory ducts terminating in wide ducts prior to penes with very thin sheaths.

St. Lawrence River, Quebec.

This species belongs to the nominate subgenus, the American species proper have a thin coiled duct between the distal wide section and the penial bulb, and are classified as the subgenus Spencerius.

2. P. californianus Brinkhurst, 1965

Anterior dorsal bundles with 2-5 finely serrate hairs, 2-4 pectinates, slightly palmate with long lateral teeth and fine intermediates, 1-2 of each posteriorly. Anterior ventral chaetae 3-4, upper tooth longer and thinner than the lower, posteriorly 2-3. Spermathecal chaetae long, thin, hollow. Male ducts with a thin section just before the penis sacs.

California and the St. Lawrence Great Lakes.

3. P. convolutus Loden, 1979

Anterior dorsal chaetae to between XIII and XV, 1-3 serrate or non-serrate hairs, 1-3 pectinates with parallel teeth, posteriorly 1-3 bifid chaetae with teeth equally long or with the upper shorter and thinner. Anterior ventral chaetae 3-4, teeth equally long or the upper longer, equally thick becoming longer and thicker posteriorly. Spermathecal chaetae long, thin, hollow. Male ducts with a terminal thin section coiled about the top of the penis sac.

Gulf Coast swamps, Florida to Mexico.

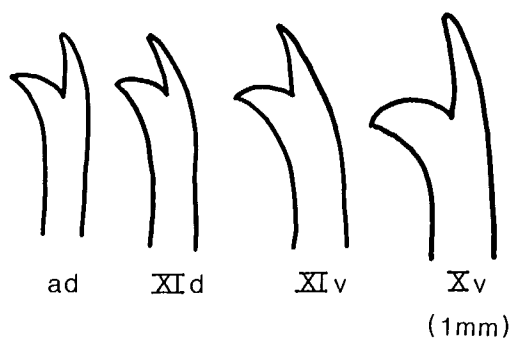

*P. moldaviensis*

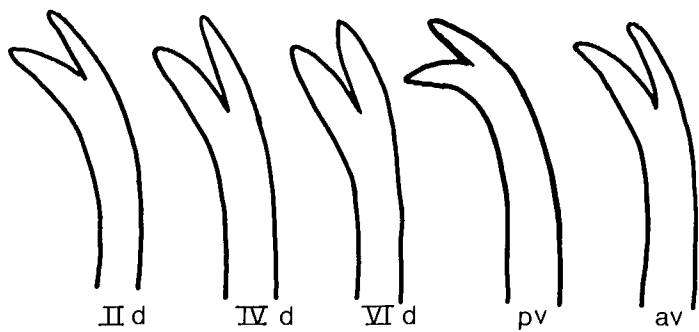
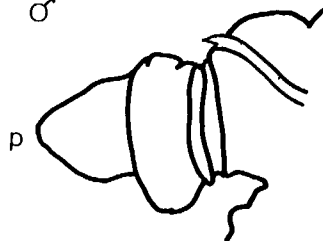
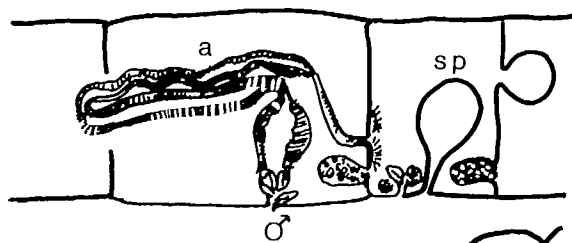

*P. vej dovskyi*

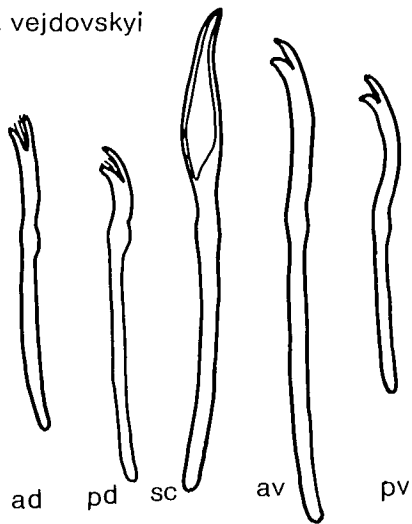
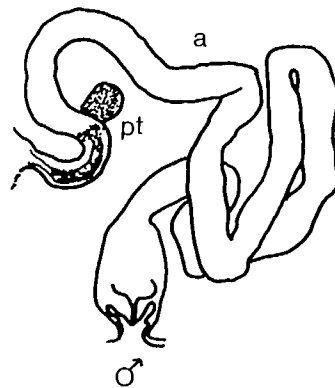

*P. bedoti*

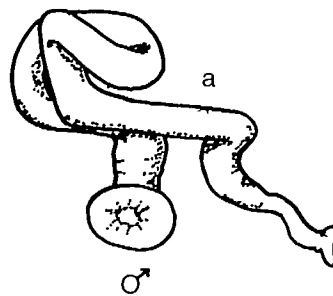

POTAMOTHRIX Vejdovsky & Mrazek, 1902

In this genus the spermathecal chaetae are characteristic, large, usually one on each ventral bundle of X, progressively changing form with degree of maturity. There are no cuticular penis sheaths. The short vasa deferentia and long cylindrical atria vary little in the genus. Holmquist (1985) separates species without hairs (Potamothrix) from those with hairs (Euilyodrilus).

1. P. moldaviensis Vejdovsky & Mrazek, 1902

All chaetae bifid, up to 9 anteriorly. Spermathecal chaetae long, hollow, with elongate teeth forming a trough shaped distal end. Penes characteristically everted, with normal ventral chaetae of XI often present. Prostate glands absent. Spermathecae in X.

St. Lawrence Great Lakes basin.

2. P. vejdovskyi (Hrabe, 1941)

Dorsal bundles with 2-4 short, bent hair chaetae, and 4-6 bifid chaetae with rounded teeth. Ventral bundles with up to 10 similar chaetae. Spermathecal chaetae long, hollow, parallel sided with a trough shaped distal end. Small prostate glands present. The spermathecae may be absent, or present in X.

St. Lawrence Great Lakes basin, Virginia, Ohio.

3. P. bedoti (Piguet, 1913)

Anterior dorsal bundles with 3-4 hair chaetae, and 3-4 pectinates with the upper tooth slightly longer than the lower, but noticeably longer in posterior bundles. Ventral chaetae 3-4 per bundle, upper teeth a little longer and thinner than the lower. Spermathecal chaetae shorter, blade shaped tip, on VII and VIII or variable on any of VI-XII. Prostate glands absent. Spermathecae in VIII rather than the usual X.

St. Lawrence Great Lakes basin.

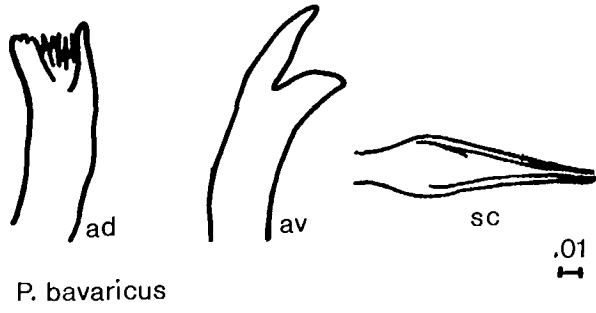

*P. bavaricus*

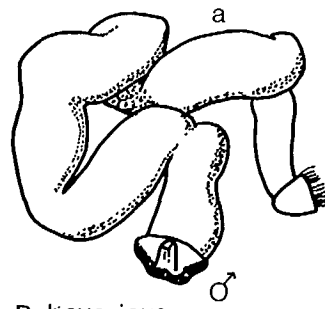

*P. bavaricus*

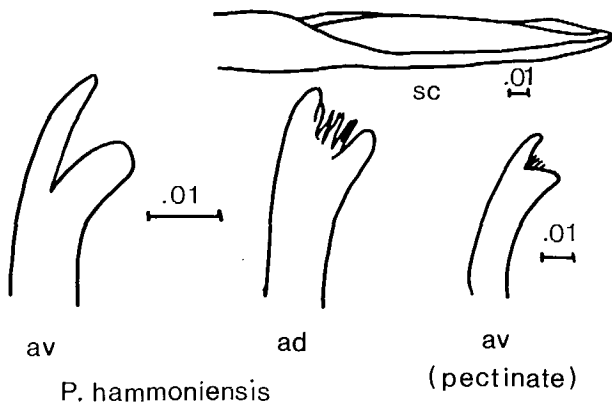

*P. hammoniensis*

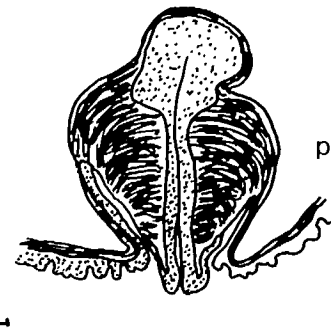
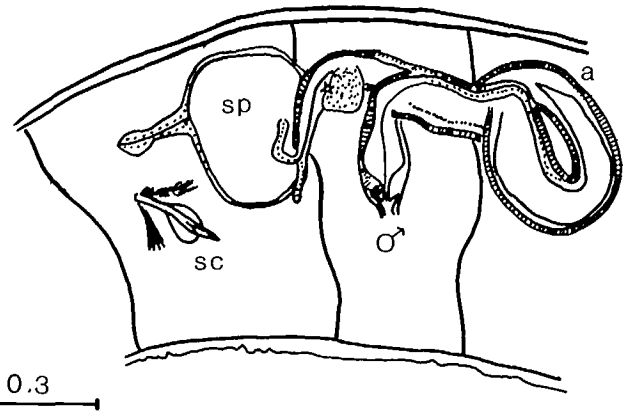

Potamothrix (continued)

4. P. bavaricus (Oschman, 1913)

Anterior dorsal chaetae 3-4 pectinates with teeth about equally long, and 2-3 hairs. Ventral bundles with 3-5 bifids with the upper teeth slightly longer and thinner than the lower. Spermathecal chaetae shorter, with broad, spear shaped tips on X. Prostate glands absent. Spermathecae in X.

Widespread.

5. P. hammoniensis (Michaelson, 1901)

Anterior dorsal chaetae 2-4 pectinates, 1-4 hair chaetae, posteriorly with 1-2 hairs and bifids. Ventral chaetae 3-5 bifids, posteriorly 2-4, the upper tooth longer and thinner than the lower. Spermathecal chaetae very large, with parallel sides and a gutter shaped distal end on X, very rarely duplicated on IX. Small prostate glands present. Spermathecae in X.

?St. Lawrence Great Lakes, ?Wisconsin.

This species has never been reported for certain in North America. Many specimens reported from the Great Lakes turn out to belong to P. vejovskyi, and only a few semi-mature specimens are available from a variety of other sites, quite widely distributed. The adults are absolutely distinctive by virtue of the huge spermathecal chaetae, and any new material should be described in the literature.



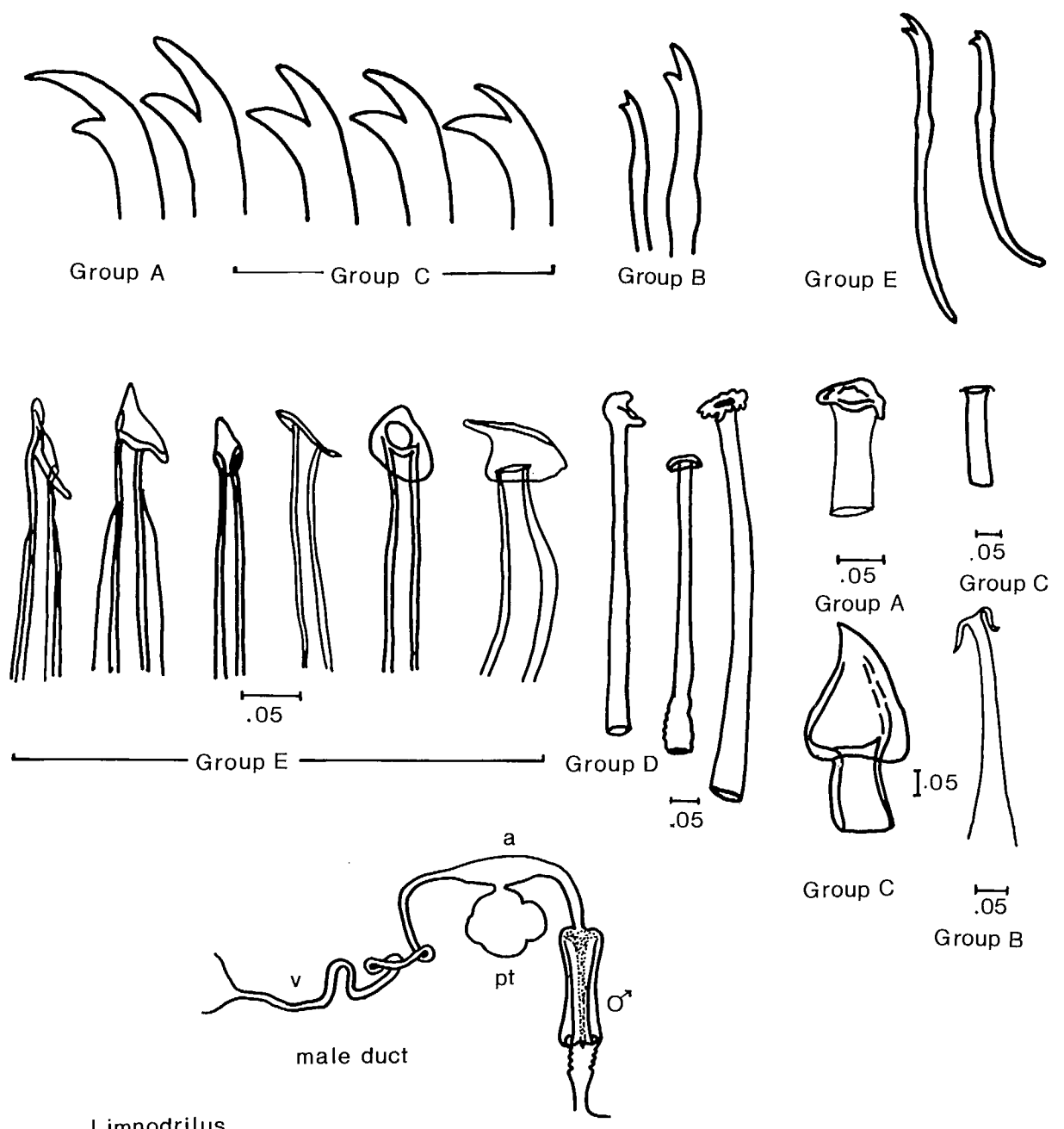

LIMNODRILUS Claparede, 1862

The chief characteristic of this genus is the cuticular penis sheath. Apart from the obvious chaetae of L. udekemianus, there are few alternative characters that can be used to separate species. Even when the penis sheaths are not fully developed, in which case they may be shorter than usual, the form of the heads and the adjacent walls are diagnostic. The illustrations may be easier to use than the keys.

There is considerable intraspecific variation in the characters used. Readers should expect to have to review a number of specimens from any given population to establish the local variants found.

- |  |                           |       |
|--|---------------------------|-------|
| 1. Anterior chaetae with the upper teeth much thicker and longer than the lower. Worms unusually large when fully developed, with short (160-200 um) broad penis sheaths.        | <u>L. udekemianus</u> (A) | p.163 |
| 2. Anterior ventral chaetae of (IV) V-IX enlarged, twice as long and thick as the others, with the upper teeth longer and thicker than the lower. Penis sheaths 350-490 um long. | <u>L. rubripenis</u> (B)  | p.163 |
| 3. Anterior chaetae without enlarged upper teeth*. Penis sheaths up to 400 um long.  | Group C                   | p.165 |
| 4. Anterior chaetae without enlarged upper teeth*. Penis sheaths mostly to 700 um long (rarely 1000 um).   | Group D                   | p.167 |
| 5. Anterior chaetae without enlarged upper teeth*. Penis sheaths more than 1000 um when fully developed.   | Group E                   | p.169 |

\* If the upper teeth of the anterior chaetae are longer than the lower, they are thinner rather than thicker.

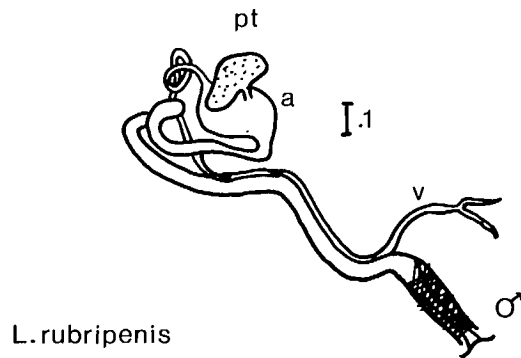
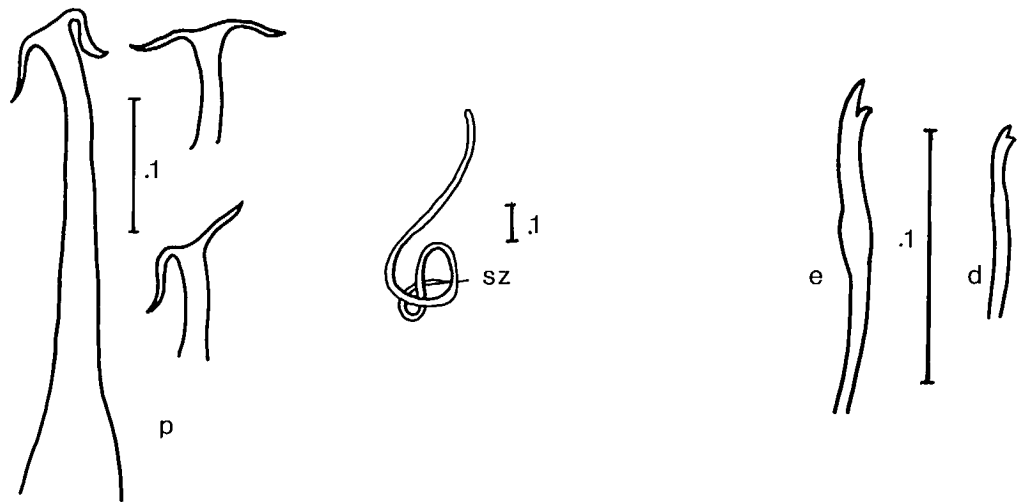
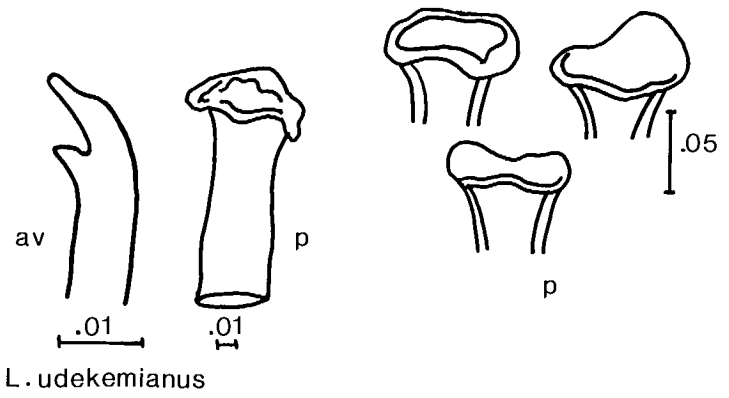

Limnodrilus (continued)

(A)

1. L. udekemianus Claparede, 1862

Anterior chaetae 3-8 per bundle, the upper teeth markedly thicker and longer than the lower, few chaetae posteriorly with the teeth more nearly equal. Penis sheaths usually up to 4 times longer than broad, with a simple plate like hood, normally reflected back over the shaft, 160-200 um long.

Widespread.

(B)

1. L. rubripenis Loden, 1977

Anterior dorsal chaetae and all posterior chaetae of similar size and shape, 3-5 per bundle, with the upper teeth thinner than but as long as the lower. The ventral chaetae of II-III (IV) resemble the dorsals, those of (IV) V-IX 2-3 per bundle, twice as long and thick as the others, with the upper tooth longer and thicker than the lower. Penis sheaths flared basally, narrowing to bilobed headplate, 350-490 um long.

Louisiana, Illinois, North Carolina.

The penes were a red-brown colour in the type specimens, but not in those from North Carolina. This is the only American Limnodrilus species with giant ventral chaetae. As L. silvani is no longer considered synonymous with L. grandisetosus, it is unlikely to be found with the giant chaetae that characterize the latter.

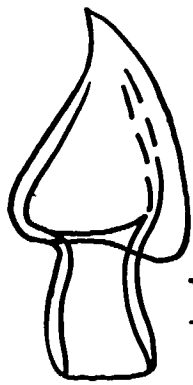

*L. silvani*

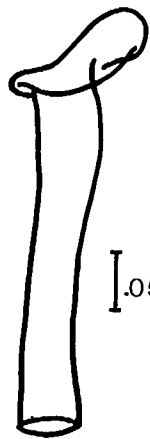

*L. profundicola*

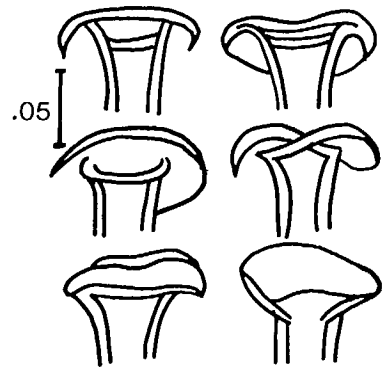

Limnodrilus (continued)

(C)

1. L. silvani Eisen, 1873

Anterior chaetae usually 3 per bundle, with the upper teeth thicker than but as long as or slightly longer than the lower teeth. Posteriorly a single chaeta per bundle. Penis sheaths short, broad, with triangular head plates.

California.

One specimen has been reported from the Niagara River, but these kinds of identifications often prove to be partially developed specimens of other species (see the head plate of L. maumeensis for example). The species is very rare. The Japanese L. grandisetosus Nomura, 1932 is no longer considered a synonym of L. silvani.

2. L. profundicola (Verrill, 1871)

Anterior bundles with 5-9 chaetae, all with the upper teeth a little longer and thinner than the lower unless worn. Penis sheaths up to 7 times longer than broad, 194-300 um long, with head plate reflected back over the shaft (unless forced forwards by pressure during slide preparation).

Widespread.

Not a common species, typically a cold water form in spring fed streams and deep lakes, or at high altitudes. This species can be found in marshes that freeze nightly at Summit Lake, Mount Evans, Colorado (above 4,000 m).



*L. hoffmeisteri*

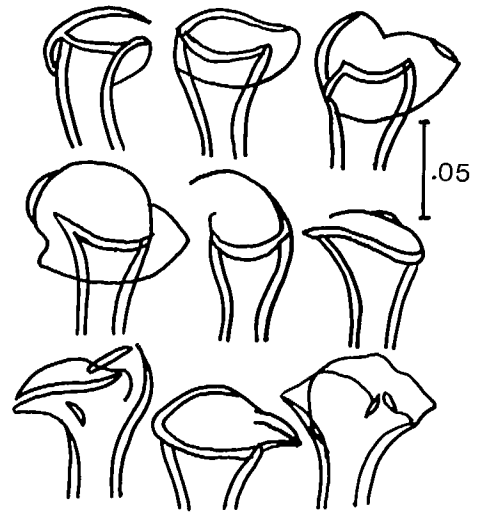
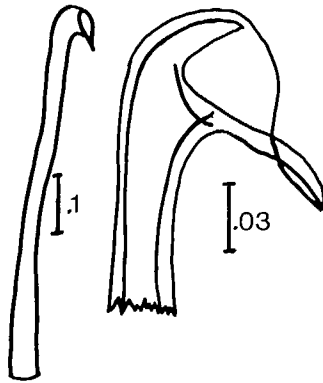

*L. angustipenis*



.05

Limnodrilus (continued)

(D)

1. L. hoffmeisteri Claparede, 1862

Anterior bundles with 3-7 (10) chaetae per bundle, posteriorly fewer, the upper teeth vary from a little shorter to a little longer than the lower. Penis sheaths up to 300-600 um long (rarely 1000 um), slightly flared for the basal third, characteristically with the opening at right angles to the shaft, the head plate forming a flared hood around the opening. The head plate can be set squarely on the shaft and may be extensively scalloped around the edges.

Widespread.

The most common tubificid in many habitats, especially in polluted sites.

There has been considerable debate about the identity of a number of species described by Eisen in the last century, notably L. spiralis Eisen, 1879. Some character other than normal anatomical characters needs to be utilized to sort out this problem, which may involve polyploidy and hybridization, but to date there is more conjecture than evidence.

2. L. angustipenis Brinkhurst & Cook, 1966

Chaetae with the upper teeth varying from longer than to shorter than the lower, both teeth short and the lower often unusually broad anteriorly. Penis sheaths thin walled basally, often crumpled, narrowing to a cylindrical form. The head plate is quite small and reflected back along the shaft or one edge is tipped up.

East of the Mississippi River and east of Manitoba.

An uncommon species, apparently from oligotrophic lakes.



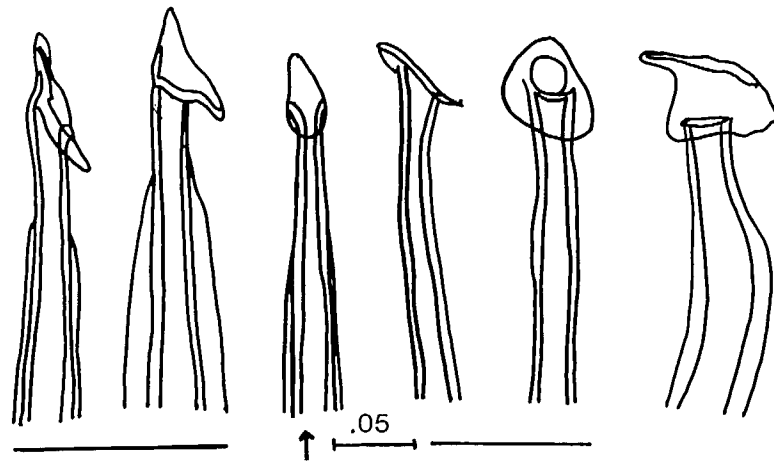

L. cervix

intermediate

L. claparedianus

L. maumeensis

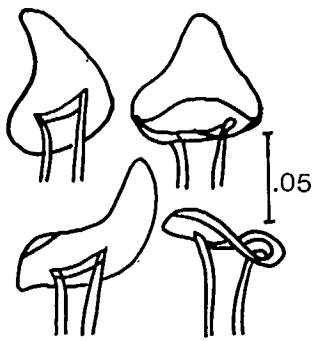

L. claparedianus

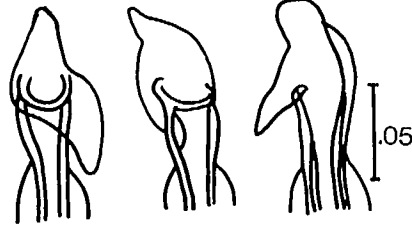

L. cervix

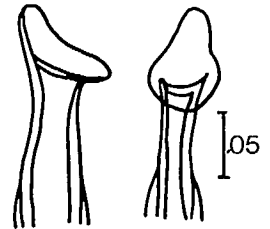

intermediate

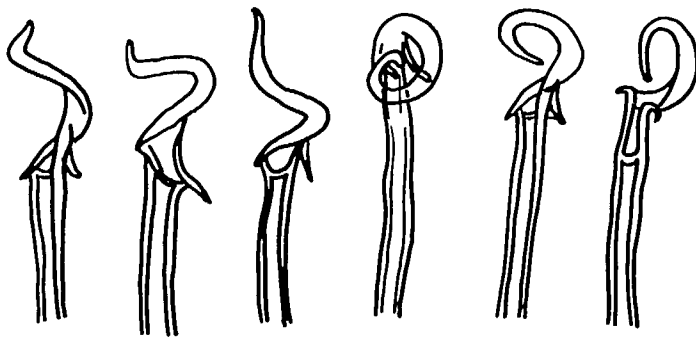
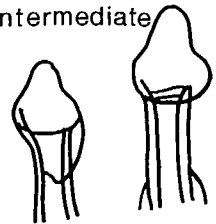

L. tortilipenis



Limnodrilus (continued)

(E)

1. L. claparedianus Ratzel, 1868

Anterior bundles with 4-9 chaetae per bundle, some with the upper teeth much longer than but as thick as or thinner than the lower, fewer chaetae posteriorly. Penis sheaths up to 50 or even 80 times longer than broad, thin, cylindrical, with small triangular head plates set at a slight angle to the shaft, up to 1300 um long, but most frequently 800-1100 um.

Widespread.

2. L. cervix Brinkhurst, 1963

Anterior bundles with 4-9 (10) chaetae per bundle, upper teeth a little longer and thinner than the lower, fewer posteriorly. Penis sheaths up to 48 times longer than broad, with very thick walls that may be distinctly two layered, except just below the ectal end where the walls narrow abruptly so that the head is set on a neck. The head plate has two small triangular projections opposite each other.

Common and widespread, especially in organically enriched situations, but not as tolerant of extremes as L. hoffmeisteri. In more heavily enriched sites there seem to be forms with less obviously thick walls that may merely be representative of L. claparedianus but do seem intermediate in form between the two.

3. L. maumeensis Brinkhurst & Cook, 1966

Chaetae up to 10 per bundle, the upper tooth a little longer and thinner than the lower. Penis sheaths up to 48 times longer than broad, with wide central tube walls thicker one side than the other, often causing a bend in the sheath. Terminal plate set eccentrically on the shaft, broadly triangular with a curved tip.

Common east of the Mississippi River.

Apparently limited to organically polluted sites, which raises more questions about the impact of pollutants on the morphology of penis sheaths in the same way as they do on chaetal form.

4. L. tortilipenis Wetzel, 1986

Anterior dorsal bundles with 5-10 chaetae per bundle, upper teeth longer and thinner than the lower, posteriorly 3-4 chaetae per bundle with the upper tooth equal to or shorter than the lower. Penis sheaths exceedingly long, 2741-4090 um, varying in width from 28-50 um basally but only 8-10 um distally, head plate basically triangular but elongate, twisted into various shapes.

Illinois.

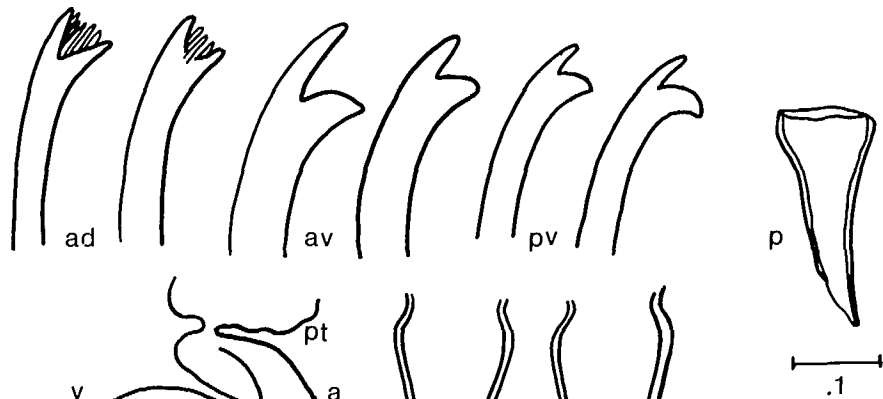

*I. templetoni*

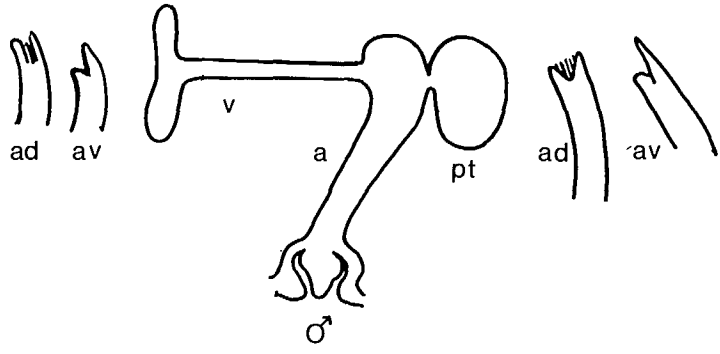

*I. perrieri*

*I. fragilis*

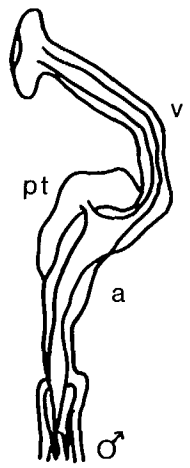

ILYODRILUS Eisen, 1873

This genus has male ducts that superficially resemble those of Tubifex but the prostates are on the posterior side, and the vasa deferentia are short and broad. In at least one of the four species, the atria become rather wide and sac-like at full maturity. The penis sheaths are conical and there are no genital chaetae.

1. I. perrieri Eisen, 1879

Dorsal bundles with 2-4 hair chaetae and 2-4 pectinate chaetae with parallel teeth, the upper as long as the lower or a little longer. Ventral chaetae 4-5 per bundle, the upper teeth longer and thinner than the lower, posteriorly 2 chaetae per bundle with teeth equal. Vasa deferentia as long as the atria, atria rather tubular, penes short, conical, possibly without penis sheaths (semi-mature worms).

Fresno, California.

This species has not been seen for certain in this century. As it is the type species of the genus, its dismissal would result in the need to rename the rest of the genus - so it cannot be left off the American species list with impunity. Brinkhurst & Jamieson (1971) tentatively identified specimens from British Columbia as I. perrieri. I. fragilis Eisen, 1879 is probably a synonym of this species. The types proved to have pectinate dorsal chaetae in contrast to the original description.

2. I. templetoni (Southern, 1904)

Dorsal bundles with 3-4 pectinate chaetae and 1-4 hairs. Ventral bundles with 3-4 chaetae, those of the most anterior bundles with the upper tooth considerably longer and thinner than the lower, teeth about equally long from IV or V. The penis sheaths are conical, with irregular lateral openings, sometimes quite long (possibly before the distal end is shed). Spermathecae present or absent.

Widespread, common.

This species is quite similar to T. tubifex on the basis of chaetal characters, but the elegant ventral chaetae of II and perhaps III in this species are distinctive. Apparently the pectinations of the dorsal chaetae may be missing.

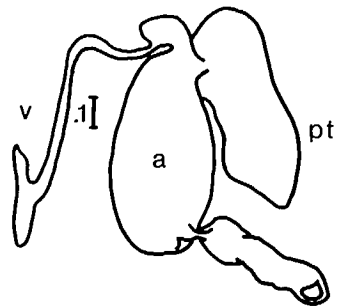
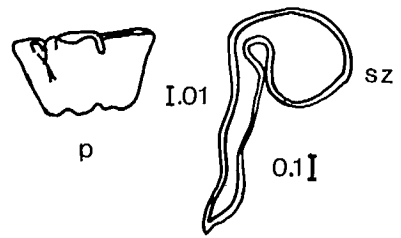
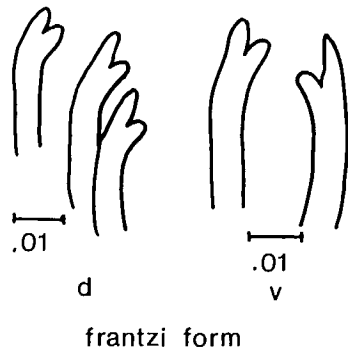
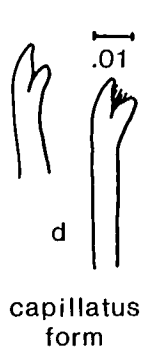

I. frantzi

Ilyodrilus (continued)

4. I. frantzi Brinkhurst, 1965

The dorsal chaetae in this species vary from 4-7 bifids in anterior bundles, to these plus 2-3 short bent hair chaetae beginning anywhere from II-V. There may even be a few pectinate chaetae associated with the most anterior hair chaetae. Odd specimens have chaetae intermediate between hairs and bifids (elongate but with fine bifid tips). The 4-7 ventral chaetae have upper teeth distinctly longer than the lower. The atria become broad and sac-like at full maturity, with narrower ejaculatory ducts. Penis sheaths are truncate cone shaped. The spermatozuogma are characteristic, with broad heads and narrow tails.

British Columbia to California, estuaries.

It is suggested that chaetal variation is associated with changes in salinity, and this is supported by evidence from other genera. Experimental evidence is being sought to substantiate this.

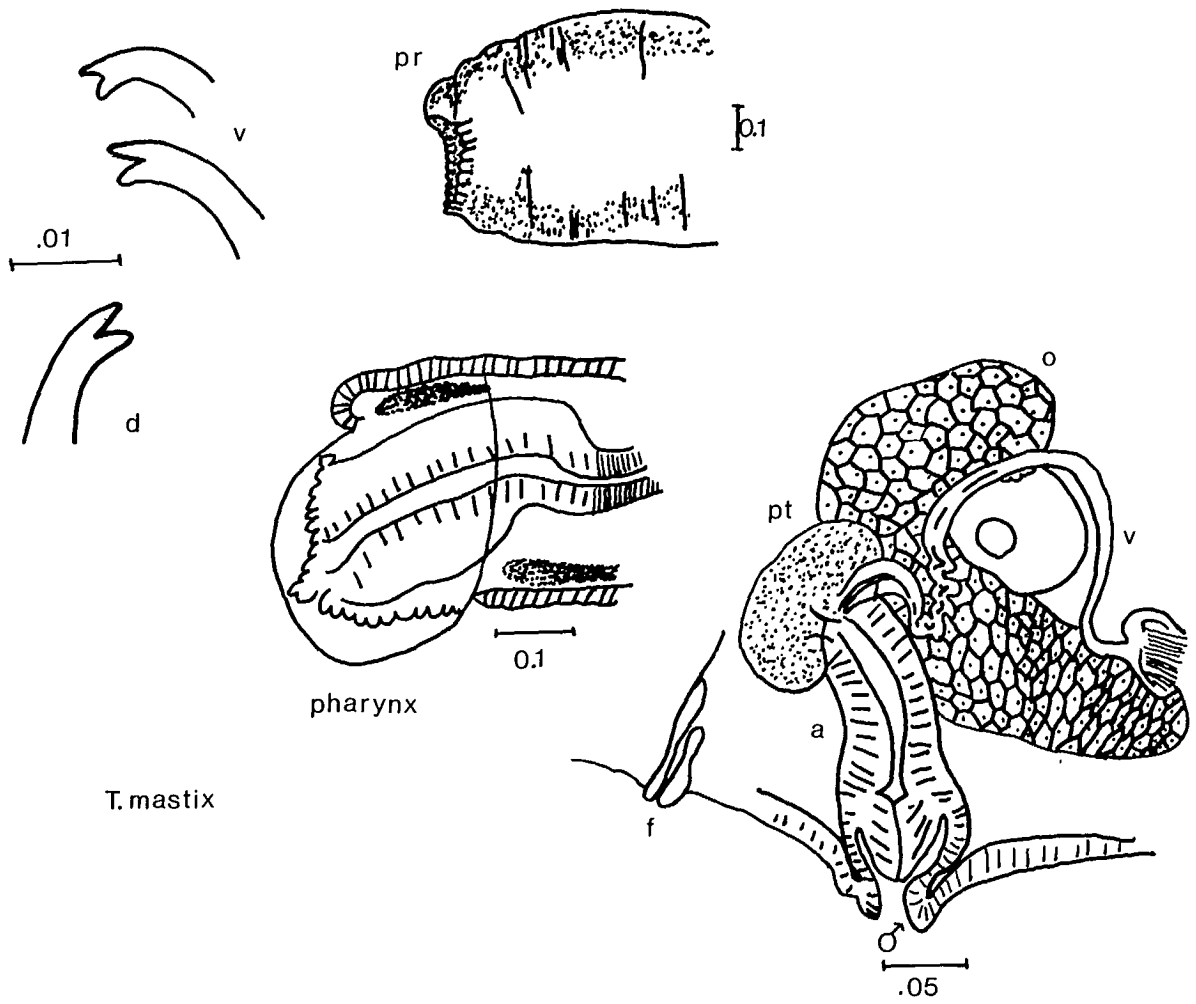

T. mastix

TENERIDRILUS Holmquist, 1985

This monotypic genus was set up for the receipt of Ilyodrilus mastix, a species that may well be parthenogenetic as it lacks spermathecae. The male ducts are somewhat like those of Ilyodrilus but the vasa deferentia are very thin - a fact that may be related to its parthenogenetic condition, but testes are present.

1. T. mastix (Brinkhurst, 1978)

Worms with a large mouth and eversible pharynx. Dorsal and ventral chaetae of III single, bifids with short upper teeth, those of II often missing. Other dorsal bundles with 2-3 (5) short hair chaetae and 2-3 bifids with upper tooth thinner than but as long as lower, other ventral bundles with 2-5 chaetae with upper teeth thinner than but slightly longer than the lower. Atria muscular, thick, with moderate sized prostates and very thin vasa deferentia, both opening about apically. No ejaculatory ducts, short thick penes without penis sheaths. No spermathecae.

Fraser River, Vancouver, British Columbia and Columbia River, Oregon.

The vasa deferentia are illustrated as entering the atria somewhat further from the prostates by Holmquist (1985). While Holmquist believes the mouth to be more usual in size, the reduced prostomium and the reduction in chaetae in II-IV are characteristic modifications of predatory worms (see Chaetogaster, Amphichaeta, Naididae).



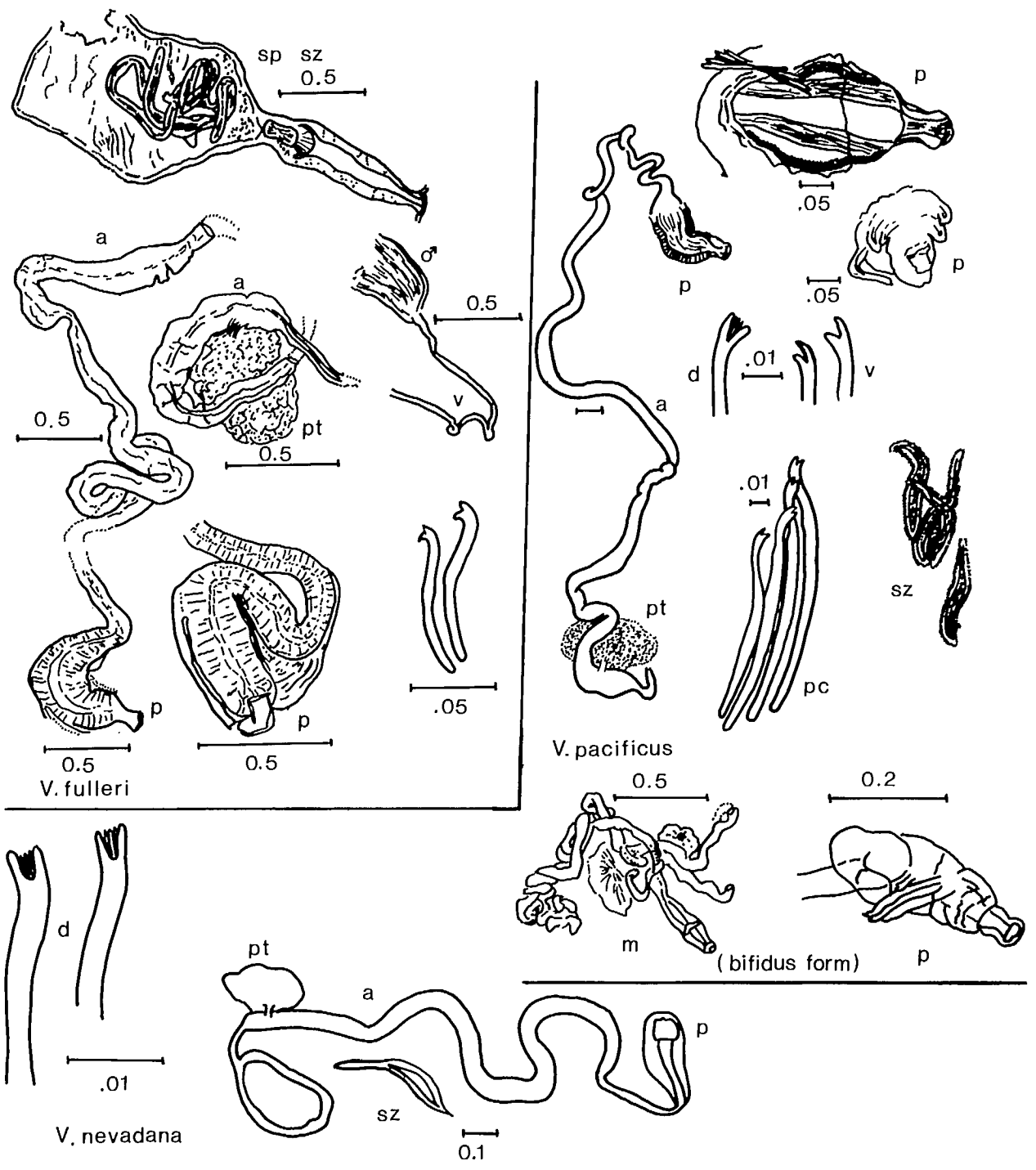

VARICHAETADRILUS Brinkhurst & Kathman, 1983

The male ducts of Varichaetadrilus species have elongate atria bearing small prostate glands. The penes appear to be erectile, with cuticular penis sheaths covering the distal ends. Some species have modified penial chaetae but they are not strongly differentiated from ordinary ventral chaetae.

1. V. pacificus (Brinkhurst, 1981)

Body wall with foreign matter in grooves. Dorsal bundles with 5-6 (10) long, smooth hairs and 5-6 (8) pectinates; posteriorly bundles with 2-3 hairs and 2-3 bifids. Ventral bundles up to 6 chaetae anteriorly, upper teeth longer and thinner than the lower, fewer posteriorly. Ventral chaetae of XI 3-4 or more bifids, slightly wider than normal. Penes with large folded basal section, erectile, tip with cuticular sheath.

Alaska, high altitudes in Washington; (V. P. pacificus).

The bifidus form with bifid chaetae alone was found in the Columbia River, Oregon.

2. V. nevadana (Brinkhurst, 1965)

Anterior bundles with 1-3 hairs and 1-3 pectinates with well separated teeth and a few distinct intermediates. Anterior ventrals with 3-6 bifid chaetae with the upper tooth longer than the lower. No genital chaetae observed. Penis sheaths thin and indistinct.

Lake Tahoe.

3. V. fulleri Brinkhurst & Kathman, 1983

Chaetae all bifid, 2-3 (5) in anterior bundles, posteriorly only 1, sometimes 2 behind XII, at first with the upper teeth shorter than the lower in II or II-III, longer in preclitellar segments, shorter and thinner posteriorly. No genital chaetae. Short penis sheaths on tips of erectile penes.

Kentucky, Louisiana.

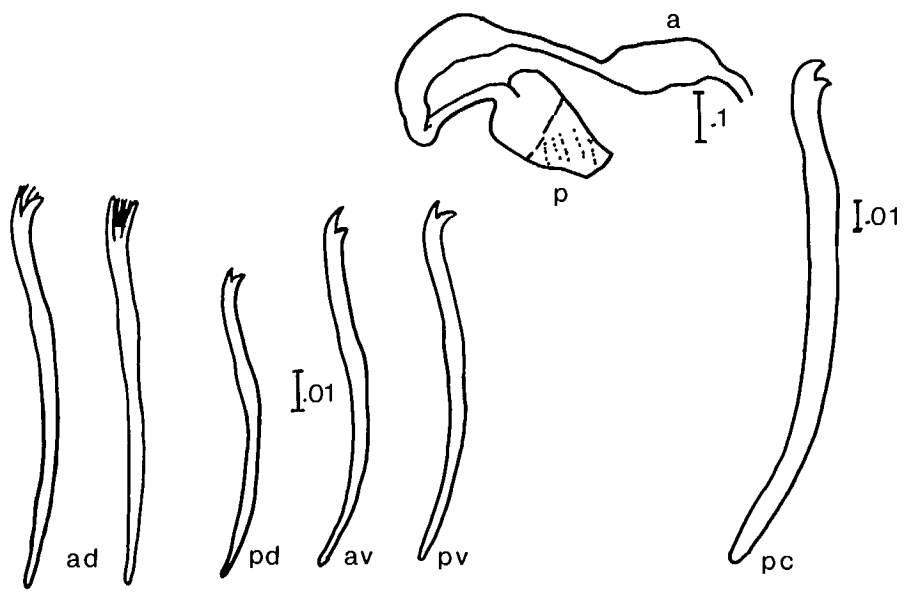

*V. minutus*

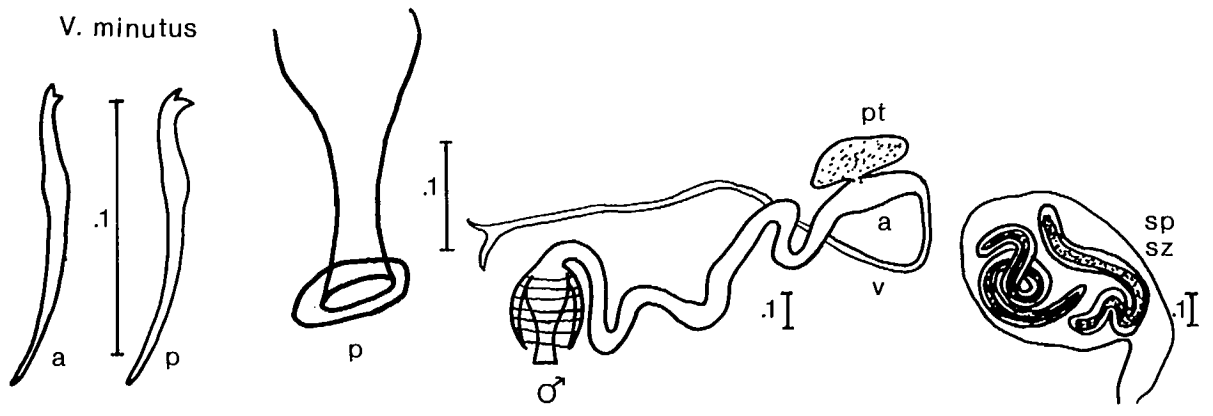

*V. psammophilus*

Varichaetadrilus (continued)

4. V. minutus (Brinkhurst, 1965)

Anterior dorsal bundles with 3-5 finely serrate hair chaetae, 3-5 pectinate chaetae, varying from somewhat palmate chaetae to those somewhat sigmoid with the upper tooth slightly longer than the lower. Hair chaetae missing from XVI or XVIII on, remaining dorsal chaetae bifid, 1-2 per bundle with shorter thinner upper teeth. Ventral bundles with 4-6 chaetae anteriorly, teeth subequal to upper longer; posteriorly 2 with the upper teeth shorter and thinner than the lower. Penial chaetae on XI, 3-4 per bundle, bifid, larger than normal chaetae. Thin cuticular penis sheaths on large penes.

Lake Tahoe and Alberta, Canada.

5. V. psammophilus (Loden, 1977)

All anterior chaetae 3-5 per bundle, upper teeth slightly longer and thinner than the lower, but often worn down. Posteriorly 1-2 chaetae per bundle, the upper teeth shorter and thinner than the lower. Penis sheath 170-330 um long, broad basally, narrowing towards the middle, flaring slightly to the head plate, which is set at nearly 90 degrees to the shaft.

Florida, Louisiana, Tennessee.

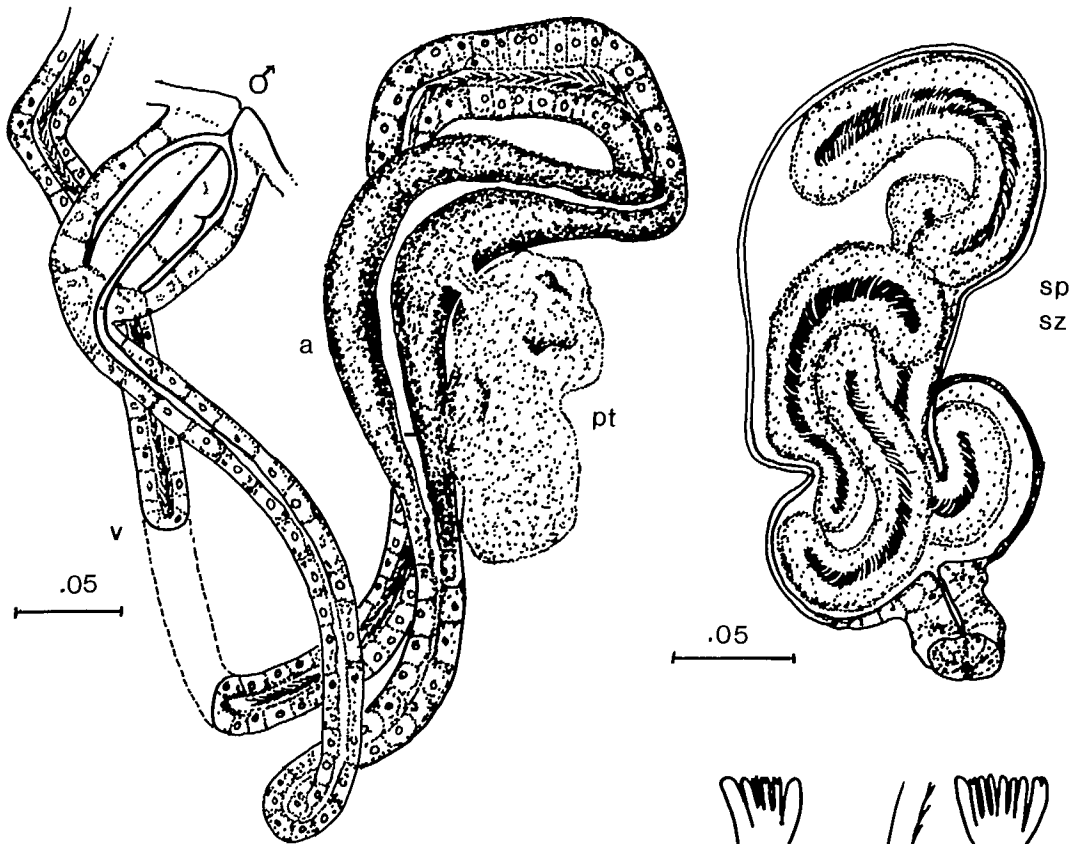

*A. wulikensis*

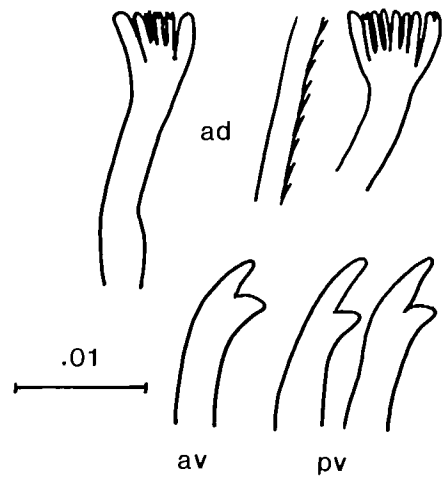

ARCTODRILUS Brinkhurst & Kathman, 1983

The single species has a very generalized male duct, with penes having normal body wall cuticle coverings only. There are no modified genital chaetae.

1. A. wulikensis Brinkhurst & Kathman, 1983

Dorsal anterior bundles with 2-4 (5) chaetae which appear palmate at lower magnifications but are actually pectinate. From XIV on hair and pectinate chaetae are replaced by 2-3 bifid chaetae. Anterior ventral chaetae 3-5 per bundle, bifid with the upper teeth thinner but only a little longer than the lower, behind XIV the upper tooth twice as long as the lower. No modified genital chaetae. Ovoid to oblong penes in cuticular lined sacs.

Brooks Range, Alaska.

It is unusual for the upper teeth of ventral chaetae to become longer rather than shorter posteriorly, as they do here.

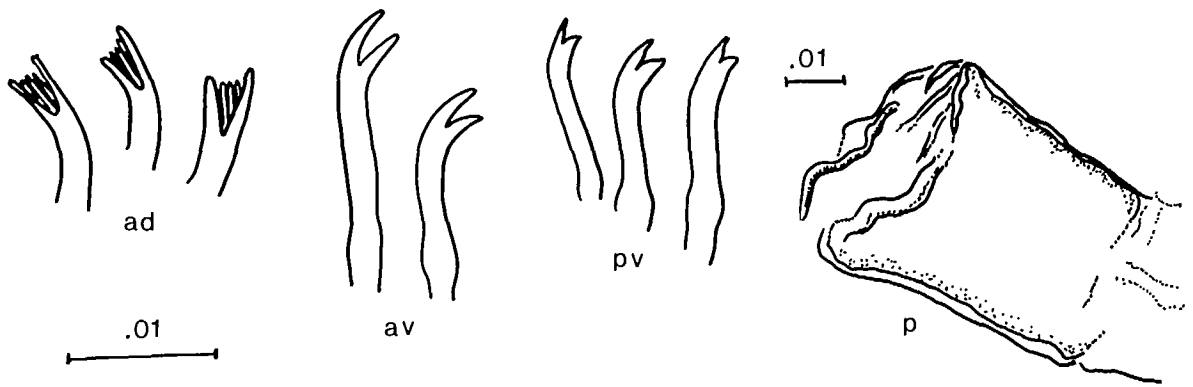

(N. America)

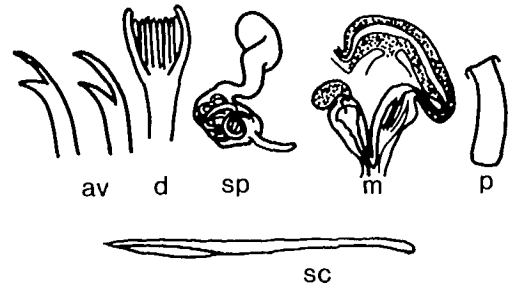
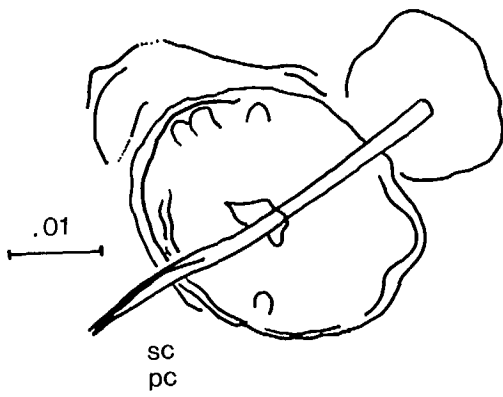

(Europe)

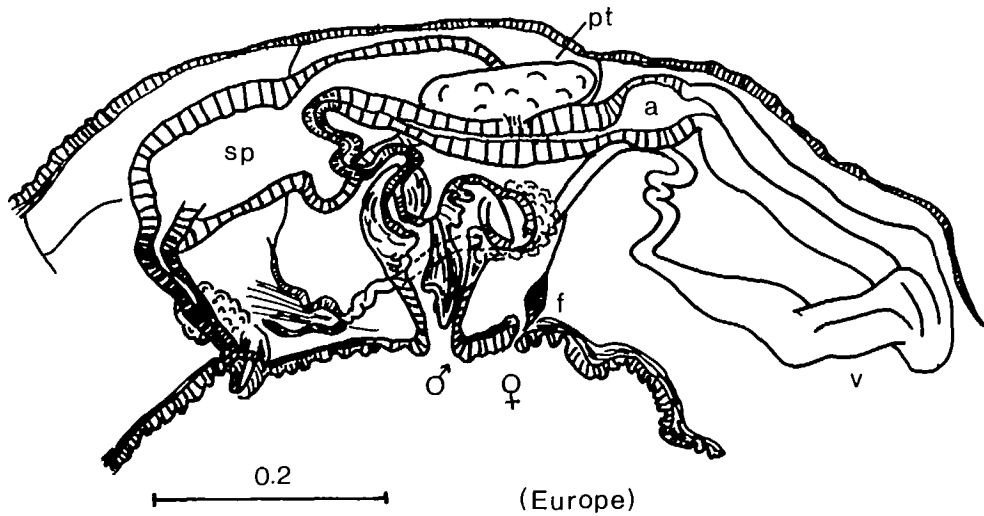

(Europe)

*H. speciosus*

1. H. cf. speciosus (Hrabe, 1931)

Dorsal anterior bundles 2-3 hair and 3-4 pectinate chaetae with long lateral teeth and fine intermediate teeth, posteriorly 1 hair and 1 bifid. Anterior ventral chaetae 3-7, with long sharply pointed teeth, posterior ventrals 1-2 per bundle with teeth equally long. Both penial and spermathecal chaetae (X,XI) modified, long, thin, hollow tipped. Apparent cuticular penis sheaths are actually basal membranes of the penial musculature.

Known from New York, South Carolina, Maryland, Virginia and Florida, in the tidal sections of rivers.

The identity of species within this genus is not yet firmly established. Many very similar taxa are known, mostly from Europe (Brinkhurst, 1981).



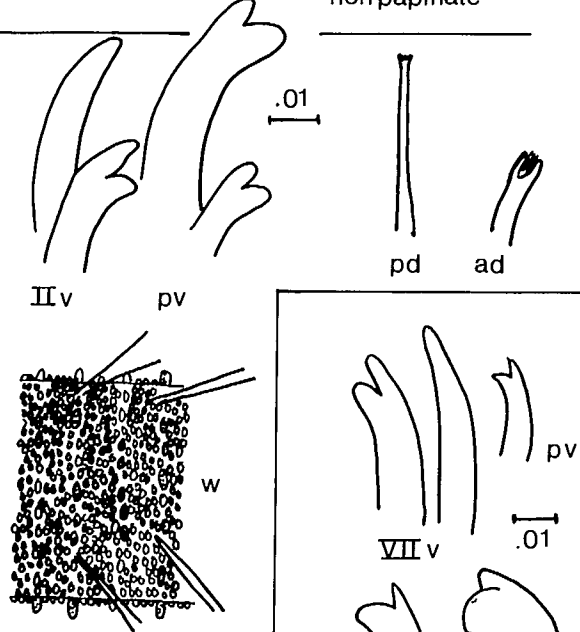
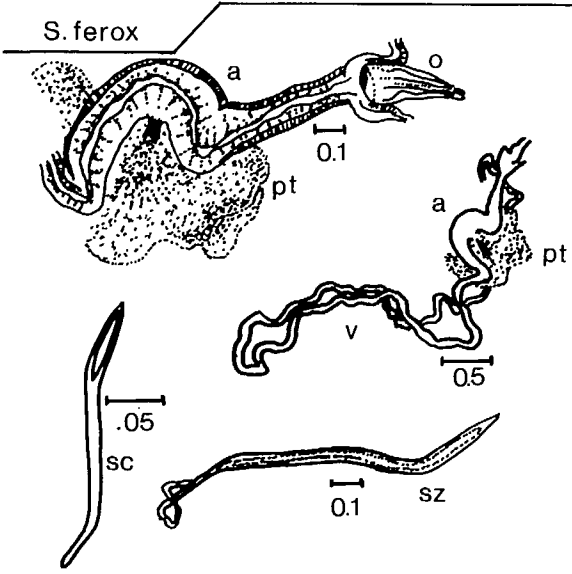
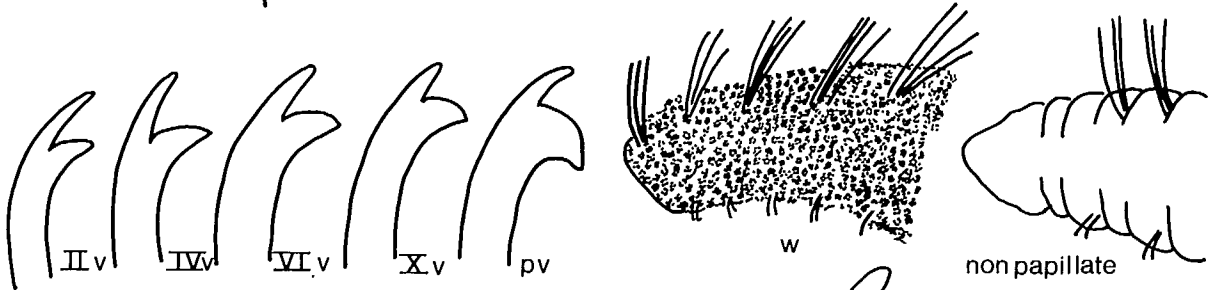
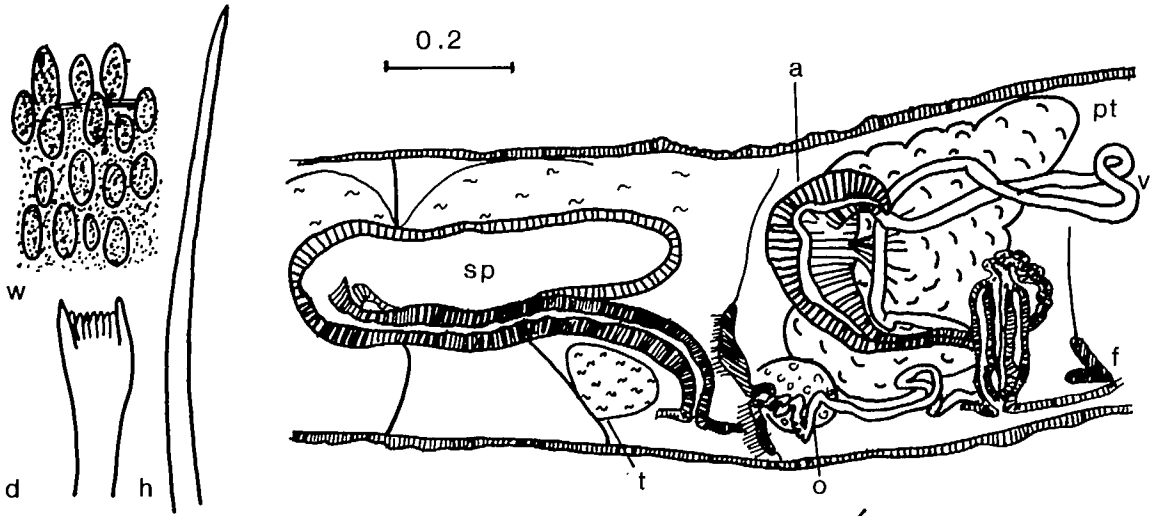

*S. nikolskyi*

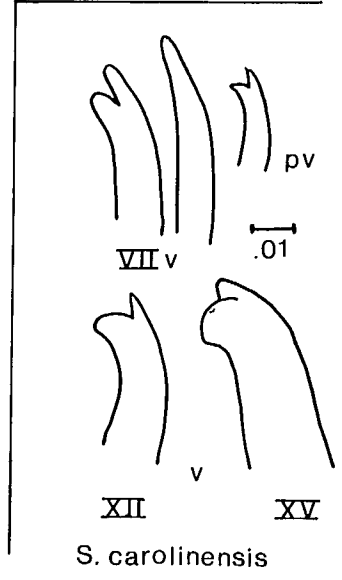
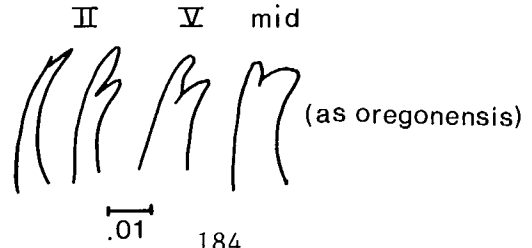

SPIROSPERMA Eisen, 1879

Most of the former Peloscolex group is now attributed to this genus, which includes both Spirosperma and Embolocephalus of Holmquist, here regarded as subgenera.

1. S. ferox Eisen, 1879

Body wall closely papillate, unless recently shed, with prostomium and I retractile. Dorsal bundles with up to 7 sabre shaped hair chaetae and 5 lyre shaped pectinates. Anterior ventral chaetae with up to 7 bifid chaetae, upper tooth a little longer than the lower which occasionally has a small additional spine; posteriorly the upper teeth shorter than the broad lower teeth. Penis sheaths present but hard to see in whole mounts.

Widespread, eastern North America.

2. S. nikolskyi (Lastockin & Sokolskaya, 1935)

=S. variegatus Leidy, 1851 sensu Brinkhurst, 1962

?=S. oregonensis Brinkhurst, 1965

Body wall papillate, prostomium and I retractile. Dorsal bundles with 2-4 hair chaetae and 2-4 hair-like chaetae with fine bifid to pectinate tips. Ventral chaetae of II-III or even IV with 1-2 simple pointed chaetae plus 1-2 bifid chaetae, the rest bifid with the upper teeth longer and thinner than the lower, sometimes with an additional spine; posterior ventral chaetae single with a broad lower tooth. Spermathecal chaetae long, thin hollow, on X. Thin penis sheaths present but hard to see in whole mounts.

Widespread.

In some western specimens the ventral chaetae have shorter teeth, especially in posterior bundles in which the teeth are rounded and the two chaetae may differ significantly in width. In S. oregonensis the anterior ventrals have quite long upper teeth but the posterior chaetae have reduced upper teeth.

3. S. carolinensis Brinkhurst, 1965

Body wall papillate, prostomium and I retractile. Anterior dorsal bundles with 3-6, or even 8, hair chaetae and 1-2 chaetae with very small bifid or pectinate tips. Ventral chaetae of II to VII or IX with 1 simple pointed chaeta and 1 bifid chaeta, the upper tooth longer than the lower; posteriorly chaetae single, becoming progressively more sigmoid, larger in the median bundles than smaller posteriorly. Spermathecal chaetae long, thin, hollow on X. Penis sheaths very thin.

Carolina, Bay Lakes, North Carolina; Marlborough County, South Carolina.

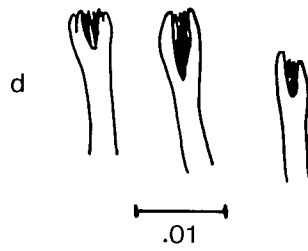
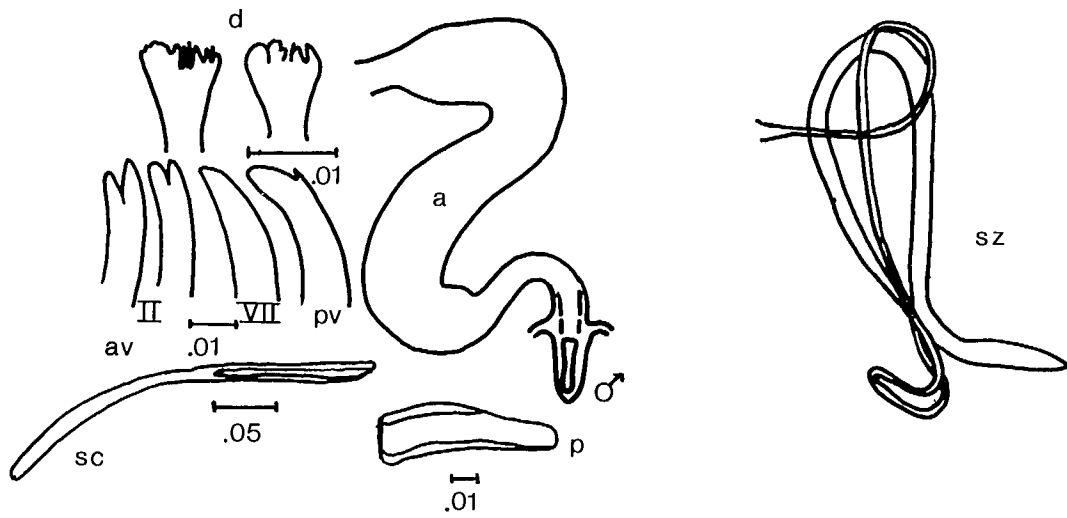

S. beetoni

Spirosperma (continued)

4. S. beetoni Brinkhurst, 1965

Body wall papillate, prostomium and I retractile. Dorsal anterior bundles with 3-4 sabre shaped hair chaetae and up to 4 small bifid, pectinate or webbed chaetae. Ventral chaetae of II-VI vary from 1 bifid and 1 simple pointed to 2 dissimilar bifids. Posterior bundles with a single chaeta with upper tooth rudimentary to absent. Spermathecal chaetae long, thin, hollow on X. Penis sheaths thin, conical.

Lake Tahoe.

P. variegatus Leidy, the type species of the genus Peloscolex, is now regarded as a forgotten name based on an indeterminable species.

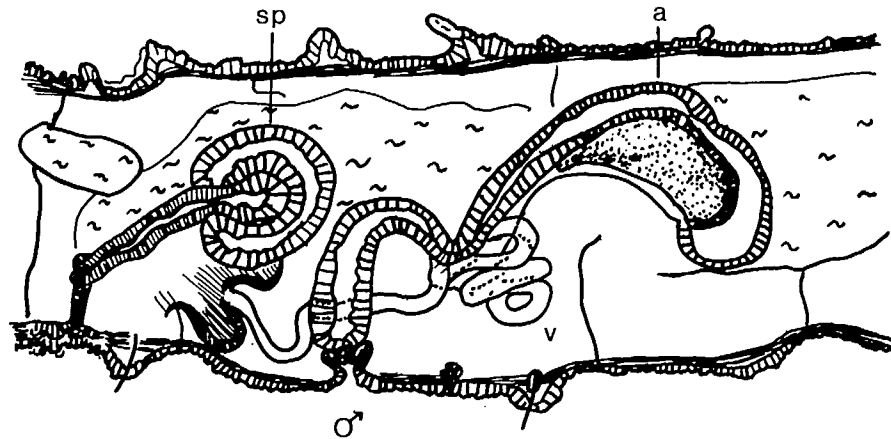
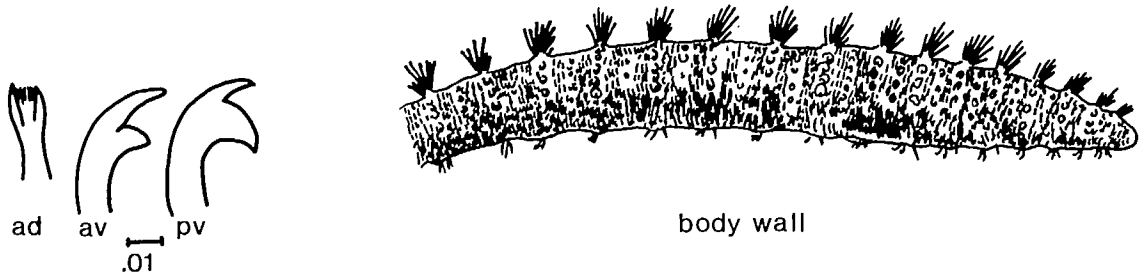

*Q. multisetosus*

0.2

QUISTADRILUS Brinkhurst, 1981

Formerly part of the polyphyletic group Peloscolex, but the male ducts have been shown to differ from those of Spirosperma (q.v.). There is a single species.

1. Q. multisetosus (Smith, 1900)

Body wall with large and small papillae in rings around the body, and foreign material attached. Anterior dorsal bundles with between 3 and 14 hair chaetae and 1-5 lyre shaped pectinate chaetae. Anterior ventral bundles with 2-3 bifid chaetae, the upper teeth long and thin, especially in II. Posteriorly either broad chaetae with short upper teeth, the distal ends curved over the shafts, or all ventral chaetae like the anterior ones. No cuticular penis sheaths.

Eastern North America, British Columbia.

Two forms are reported, the typical one in which the posterior ventral chaetae differ from the anterior ventrals, the other (Q. m. longidentus) in which the posterior ventrals resemble the anterior ventrals.

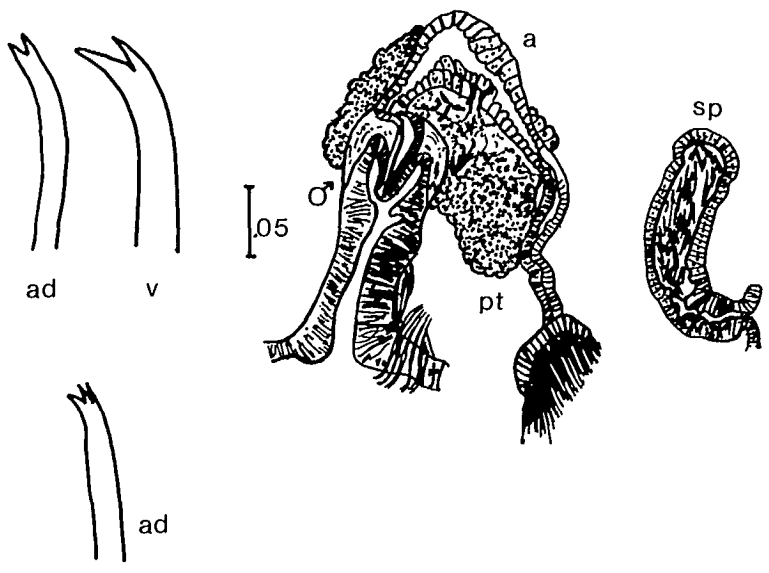

A. pluriseti

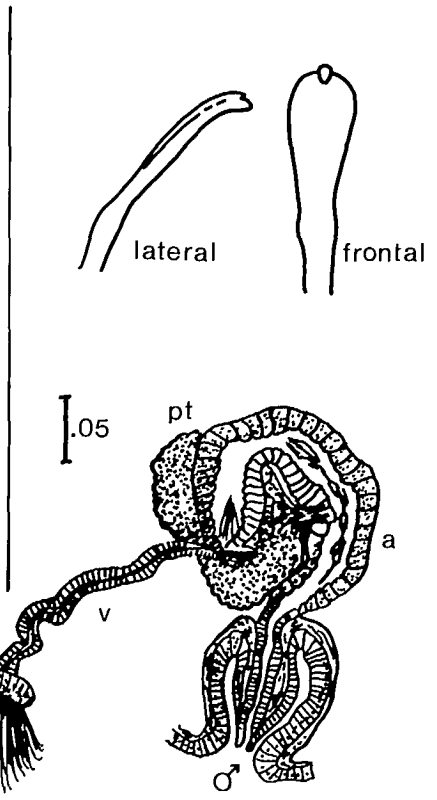

A. limnobiis

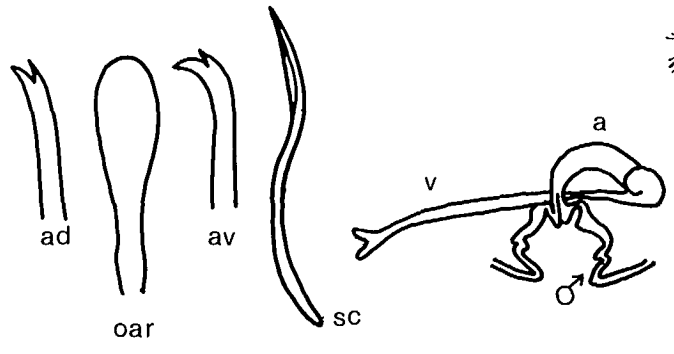

A. pigueti

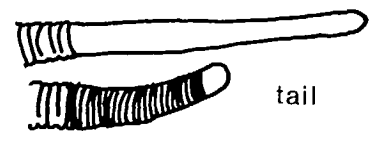

A. japonicus of Hrahe

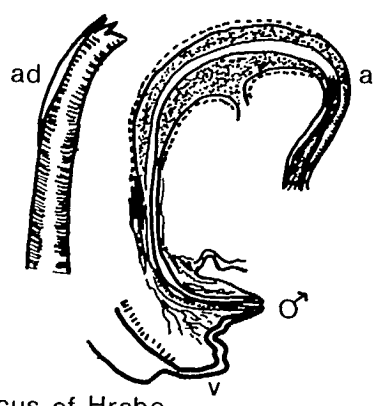

AULODRILUS Bretscher, 1899

This genus used to be regarded as having prostates attached to the atria by broad bases, but recent studies show them to be stalked. Similarly, there are now known to be true penes, not eversible pseudopenes. There are no spermatozogma, but this has been seen in a few other tubificines, all of which may have unusual modes of reproduction. Aulodrilus species often reproduce asexually, and are often found in mesotrophic or weedy situations. They may be found in tubes of sediment glued together.

1. A. limnobius Bretscher, 1899

Up to 10 chaetae per bundle anteriorly, all with the upper teeth shorter and thinner than the lower, those of the first bundles shorter, thicker and more strongly curved than the rest. Chaetae of mid and posterior bundles with lateral keels. The true penes lack cuticular penis sheaths.

Widespread.

2. A. pluriseta (Piguet, 1906)

Anterior dorsal bundles with up to 8 short hair chaetae and up to 10 bifid chaetae with short thin upper teeth that are frequently replicate. The ventral chaetae may number up to 16 per bundle anteriorly, with short, thin upper teeth. The penes lack penis sheaths.

Widespread.

Hrabe (1981) identified the form with replicate upper teeth on the dorsal chaetae as A. japonicus Yamaguchi, 1953.

3. A. piqueti Kowalewski, 1914

Some or all dorsal bundles from II-IV or VII without chaetae or at least hair chaetae absent, otherwise 2-5 short hair chaetae per bundle accompanied by 4-5 (or even 10) bifid chaetae with short thin upper teeth. From about VII on the dorsal bifid chaetae become oar shaped with the blade in the same plane as the normal teeth (which may be visible on the blade). There are 4-11 ventral chaetae with short, thin upper teeth. The penial chaetae are strongly modified in the few fully mature specimens seen, 1-2 per side, spoon shaped, often the male segment further anterior than usual (VIII commonly). The penes lack penis sheaths.

Widespread, often with other Aulodrilus species.



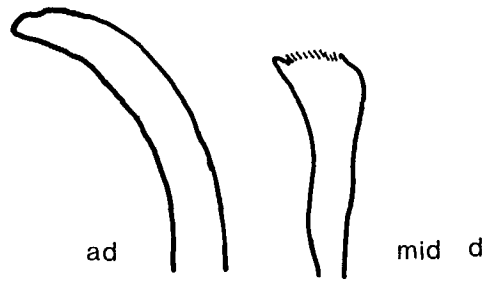

*A. americanus*

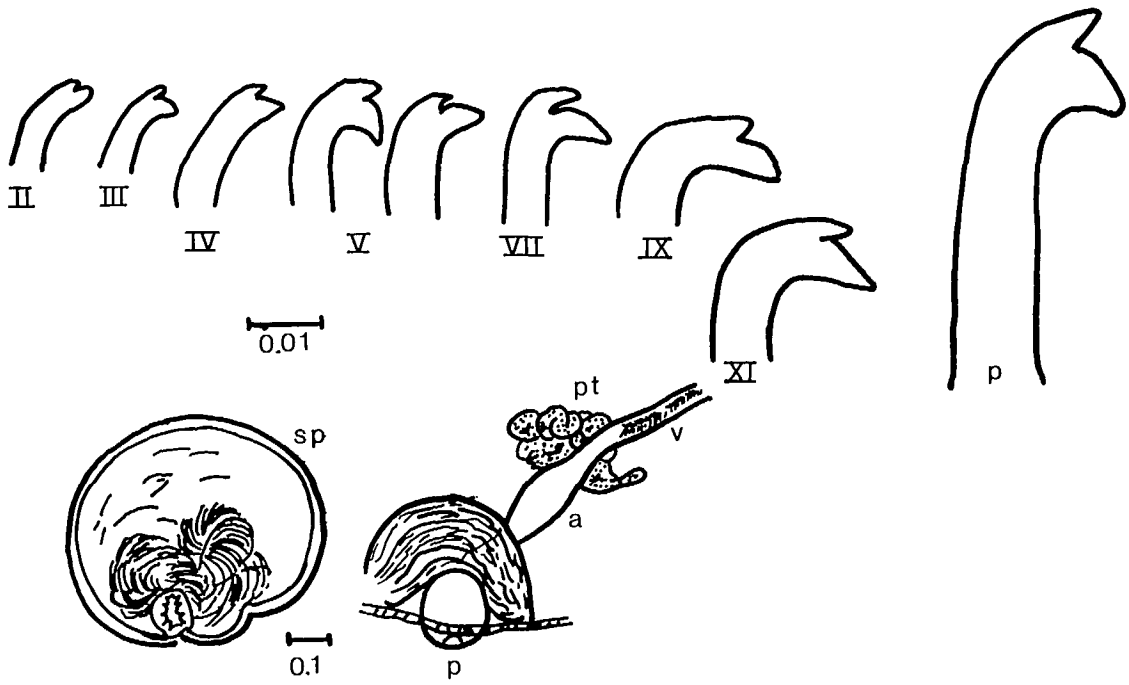

*A. paucichaeta*

Aulodrilus (continued)

4. A. americanus Brinkhurst & Cook, 1966

Anterior bundles with up to 10 chaetae, simple pointed or with a rudimentary upper tooth, from VI on all chaetae palmate, mostly 8 per bundle, fewer posteriorly.

Eastern states, Northwest Territories, Saskatchewan and eastwards.

The external tubes are more permanent than in other species in this genus. The penes are presumably like those of the other species and not eversible pseudopenes as stated in the original description. This point requires clarification.

5. A. paucichaeta Brinkhurst & Barbour, 1985

Anterior bundles with 2-3 chaetae with the upper teeth shorter and thinner than the lower, progressively enlarging to IX, postclitellar segments with 4 solitary chaetae, all chaetae with the upper teeth shorter and thinner than the lower, the lower teeth becoming thick and recurved posteriorly. Large penes lacking cuticular penis sheaths are present in voluminous penis sacs, atria are small with quite long vasa deferentia. The spermathecae have lateral pores and are almost devoid of spermathecal ducts.

Piscataway Creek, a tributary of the Potomac River near Washington, D.C.,  
?North Carolina.

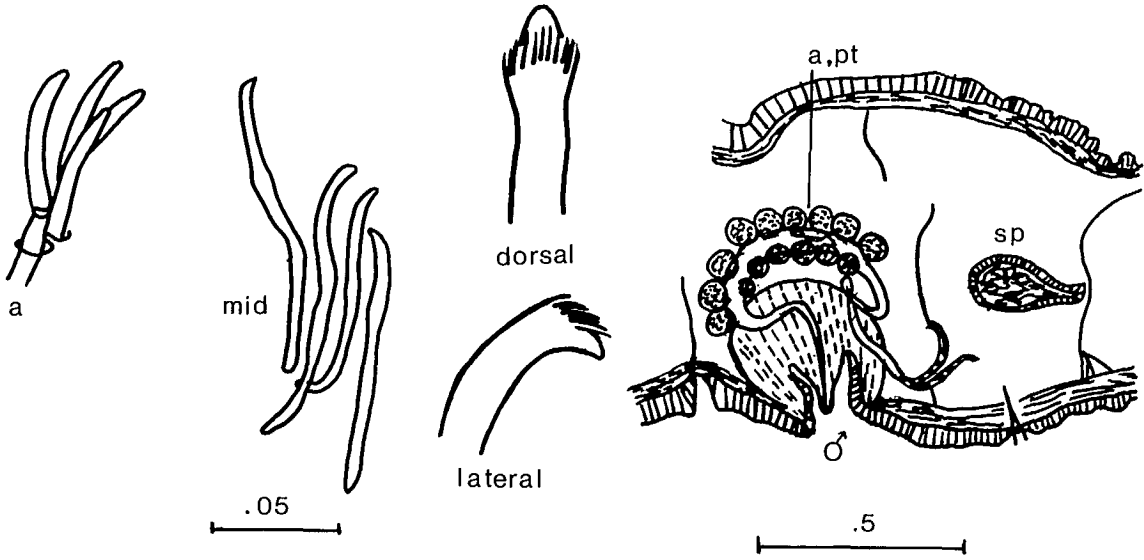

T. vejdoovskyi

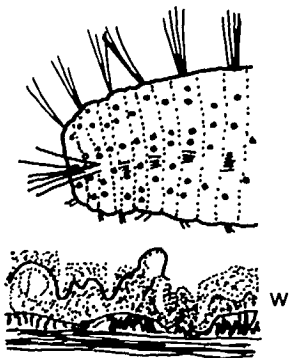
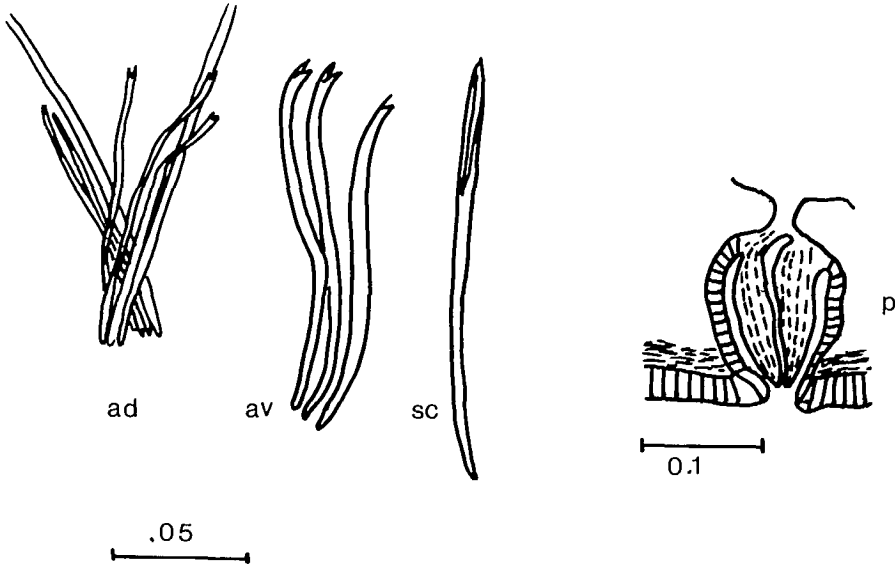

T.(A.) onegensis

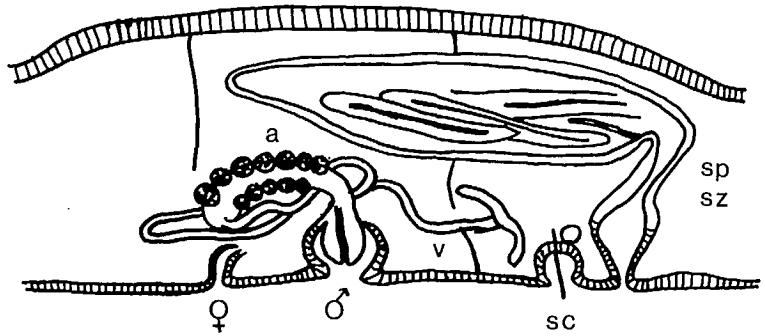

TELMATODRILUS Eisen, 1879

This genus has a series of discrete prostate glands along the cylindrical atria. The two species may belong to distinct genera, treated here as subgenera. The nature of the body wall in itself may not be a sufficient distinction between genera, as it varies within what are considered to be single genera elsewhere in the family.

1. T. vejnovskyi Eisen, 1879

Large worms, with 6-14 chaetae per bundle. Chaetae simple pointed in the preclitellar bundles, behind the clitellum of a unique form with multiple tips, described as brush-like. No modified genital chaetae. The cylindrical atria end in large muscular penial bulbs and protrusible penes without sheaths. The body wall is thick but not papillate.

California to British Columbia.

T. mcgregori Eisen, 1900 is considered by me to be a synonym. These two species may be referred to the nominate subgenus.

2. T. (Alexandrovina) onegensis (Hrabe, 1962)

Anterior end retractile, body wall of the rest papillate and covered with foreign matter. Anterior dorsal bundles with 3-6 long hair chaetae and 1-6 short hair like bifid chaetae. Ventral bundles with 2-4 bifids, the upper teeth twice as long as the lower in II, becoming progressively shorter until they are equal in the 1-2 posterior chaetae. Spermathecal chaetae long, thin, parallel sided. Atria are long and cylindrical, and end in quite large protrusible penes in thin walled sacs. Spermatozeugma are present (but it is not known if these are homologous with those of the tubificines).

Northern Alaska.

This subgeneric name is used at the generic level in many publications, with some justification.

*R. coccineus*

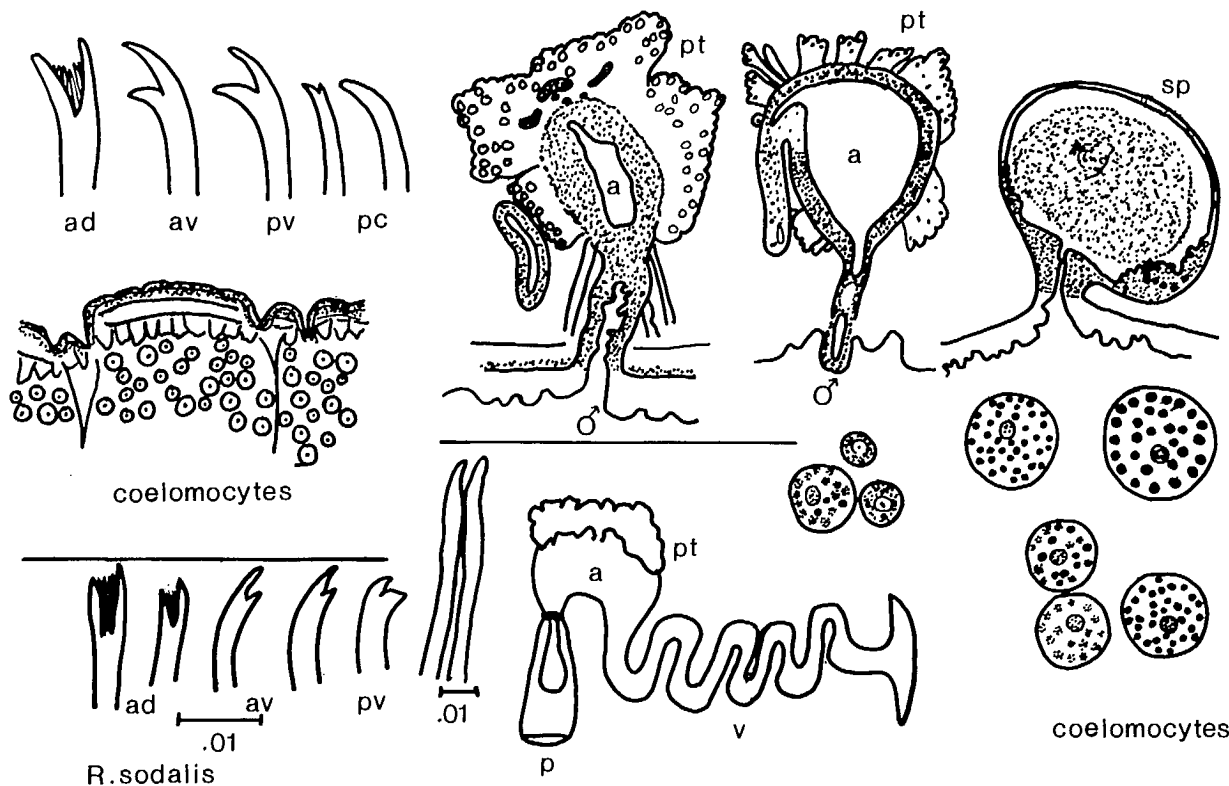

RHYACODRILUS Bretscher, 1901

In this genus coelomocytes are present, and modified penial chaetae are usually present. Many species have been described quite recently, but the North American situation seems quite stable despite the need for a generic revision.

1. R. coccineus (Vejdovsky, 1875)

Anterior dorsal bundles with 3-5 hair chaetae and up to 6 pectinates of very general form. Hair chaetae missing from postclitellar bundles. Anterior ventral bundles with 3-5 (9) chaetae with upper teeth longer and a little thinner than the lower. On each side of XI there are 3-5 modified penial chaetae with long proximal ends and short knobbed distal ends with the tips bunched together. There are no spermatozoa. The atria are globular.

St. Lawrence Great Lakes, Wisconsin, and across Canada.

This is probably a northern and upland species that is more widely distributed than the records suggest.

2. R. sodalis (Eisen, 1879)

Anterior dorsal bundles with 2-3 hair chaetae and up to 6 pectinate chaetae with long teeth and very fine intermediate teeth. Posteriorly 1 hair and 1-2 pectinate chaetae with shorter teeth. Anterior ventral chaetae up to 6 per bundle with the upper tooth longer and thinner than the lower, becoming shorter posteriorly. Penial chaetae in the familiar fan shaped groups of 2-4 knobbed chaetae with the tips closely bunched. Atria globular to ovoid.

Widespread but rare, this species is of somewhat uncertain taxonomic status. In the initial report by Brinkhurst & Cook (1966) forms with typical chaetae were reported along with some with hairs and bifid chaetae and some with only bifids. This has not been confirmed by later accounts. Some of these variants are keyed as R. coccineus by Stimpson et al. (1982).

3. R. montana (Brinkhurst, 1965)

Anterior dorsal bundles with 3-5 pectinate chaetae, with the upper tooth much longer than the lower, accompanied by 4-6 serrate hairs, the hair chaetae of II being exceptionally long. Median dorsal bundles with up to 6 bifid chaetae, the upper tooth much longer than but as thick as the lower, sometimes with small additional spines, posteriorly fewer with the teeth equally long but the upper thinner than the lower. Penial chaetae in fan like bunches with the heads closely approximated in XI. Coelomocytes large. Posterior end of the body quadrangular.

Alaska, St. Lawrence Great Lakes basin and across Canada. A northern and upland species.

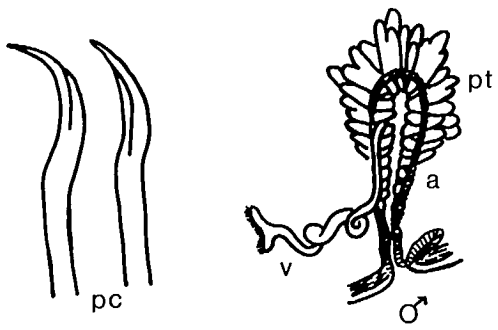

*R. falciformis*

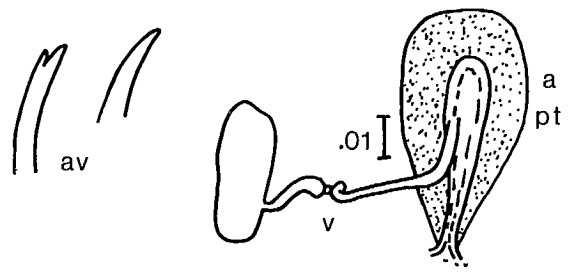

*R. brevidentatus*

Rhyacodrilus (continued)

4. R. brevidentatus Brinkhurst, 1965

Dorsal anterior bundles with 1-2 hair chaetae and 1-2 bifids with short, thin, upper teeth. Ventral bundles with up to 4 simple pointed or bifid chaetae with reduced upper teeth. Penial chaetae not reported. Atria elongate, pear shaped.

Lake Tahoe.

5. R. falciformis Bretscher, 1901

All chaetae bifid, 3-4 (5) per bundle with the upper tooth longer and thinner than the lower, the lower sometimes with an additional spine. Penial chaetae in XI twice as long and much thicker than normal, sickle shaped, 1-2 per side. Atria elongate pear shaped.

New York (Hudson River) and Vancouver Island, British Columbia.

The species has now been found in a cave on Vancouver Island, a site less likely to have been the site of an accidental introduction than the airport boundary creek where it was initially found, presumably arriving in the creek from its ground water source.

Rhyacodrilus punctatus Hrabe, 1931 may be no more than a version of R. coccineus with pectinate ventral chaetae. Varying degrees of pectination are observed in the ventral chaetae of many species with hair and pectinate chaetae in dorsal bundles, but it is usually limited to a few supernumary teeth or even a single spine. I do not regard this as a North American species, if it exists at all.



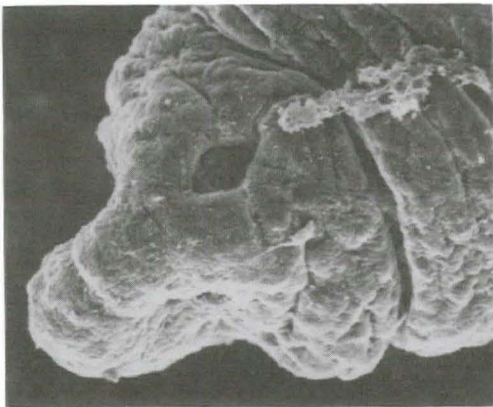
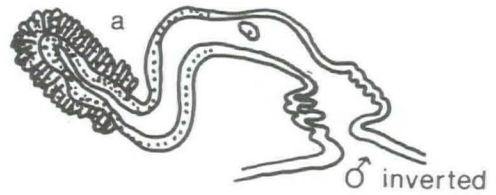
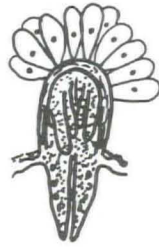
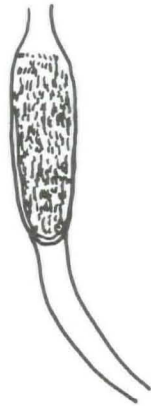
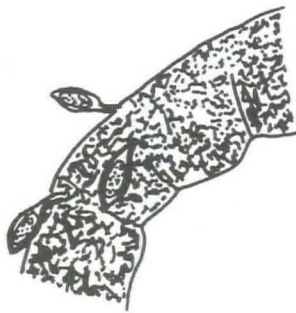
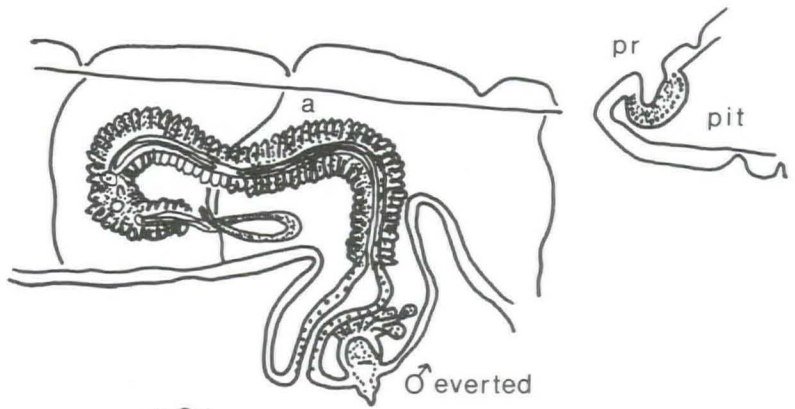
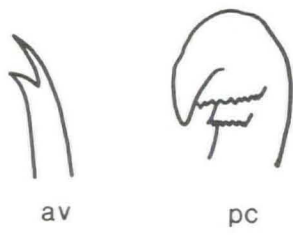

B. vejdoskyanum

BOTHRIONEURUM Stolc, 1888

This genus is characterized by a unique sensory organ located on the prostomium mid dorsally. The pore leading into it can be observed from above; in the common lateral view it appears as a thickening of the prostomial wall. Coelomocytes are abundant. There are no spermathecae, instead external spermatophores are attached to the genital region in the few mated specimens observed.

1. B. vejdovskyanum Stolc, 1888

Prostomial pit present. Chaetae all bifid, mostly with upper teeth up to twice as long as and thinner than the lower, anteriorly 2-4 chaetae per bundle, posteriorly only 2. Penial chaetae in fan-like bundles in X, proximally long and straight, short distally with bifid knobbed swollen tips bunched together. Atria cylindrical, opening into wide eversible chambers bearing paratria, male pores open via a median chamber on the ventral side of XI. The cuticle is ornamented and may appear spotted or papillate.

Widespread, especially in sandy situations.

Specimens lacking penial chaetae when mature are classified as B. americanum Beddard, 1894. This South American form has been reported from Georgia and Louisiana. Recent study of South American material (Brinkhurst, unpublished) supports the view that very little separates the two species and they are probably synonymous.

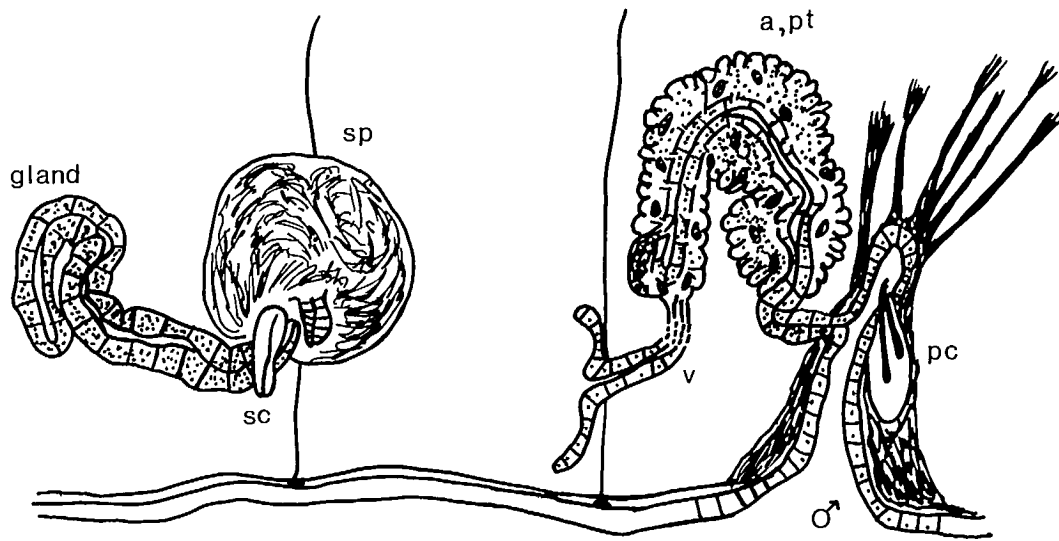

0.3

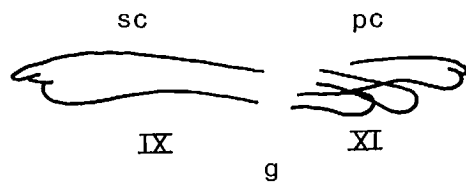

R. lacteus

RHIZODRILUS Smith, 1900

The single species in this genus has unusual genital chaetae, and the elongate cylindrical male ducts open into a large median copulatory bursa. Spermathecae are present. Coelomocytes are abundant, at least anteriorly.

1. R. lacteus Smith, 1900

All anterior dorsal and ventral bundles with 5-6 bifid chaetae, posteriorly 1-4 with broad lower teeth. Ventral chaetae of IX a single, large, spatulate chaeta on each side associated with a long cylindrical gland; those of X similar or unmodified, those of XI 4-6 penials on each side, straight with thick rounded tips. Spermathecal pores anteriorly on X, in chaetal line. The edges of XI folded to form porophores on each side of a median bursa. No spermatozeugma.

Havana, Illinois and Aiken County, South Carolina remain the only two localities for this unusual species.

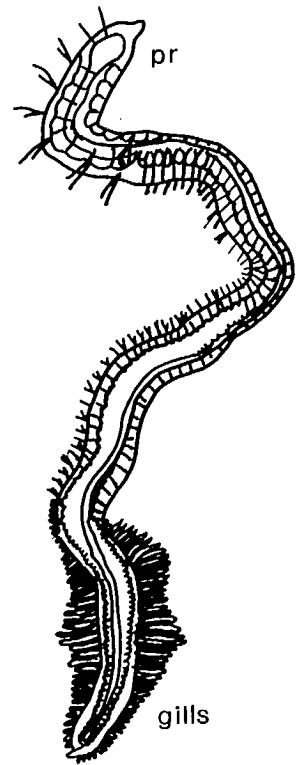
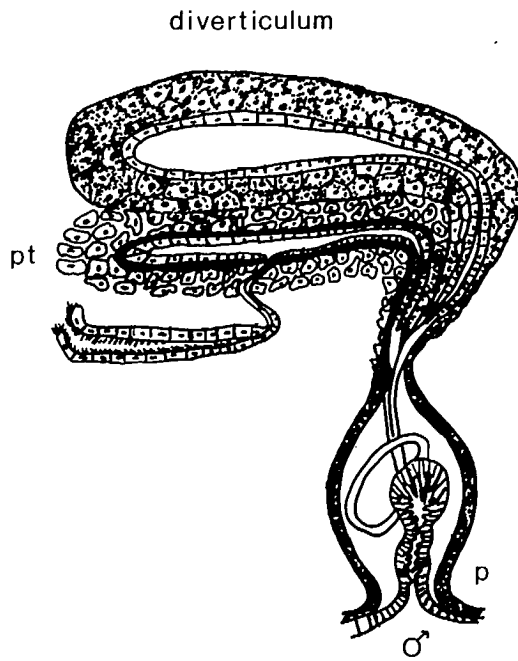

*B. sowerbyi*

BRANCHIURA Beddard, 1892

This monotypic genus is instantly identifiable because of the solitary dorsal and ventral gill filaments on each of the posterior segments.

1. B. sowerbyi Beddard, 1892

This worm may be large, especially in artificially warm water. The dorsal bundles contain 1-6 short hair chaetae and 7-12 chaetae with short thin upper teeth that appear bifid, but which have replicate upper teeth when examined under oil immersion lenses. Ventral bundles with up to 14 bifid chaetae with short thin upper teeth. There is a single median male pore, the atria have glandular diverticulae and there are eversible pseudopenes.

Widespread.

Broken anterior fragments might be erroneously identified as Aulodrilus pluriseta as there are similarities in chaetal form and number.

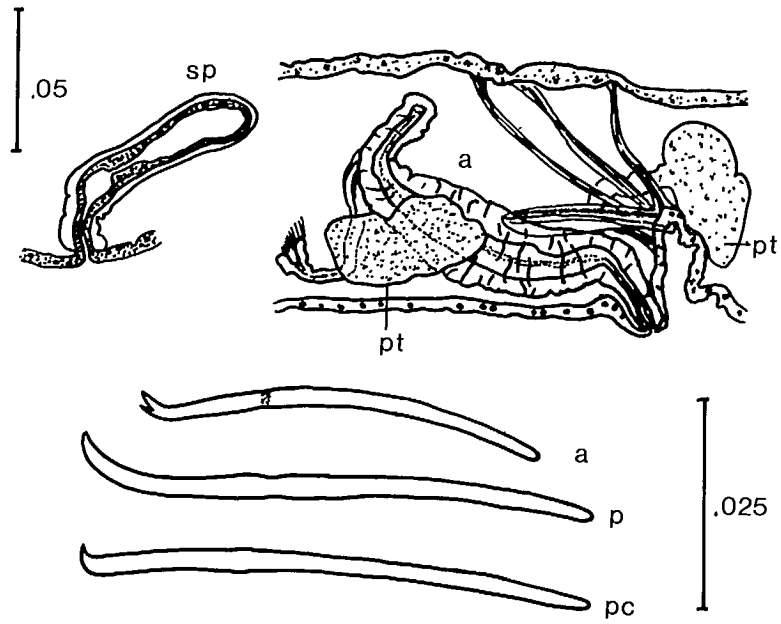

PHALLODRILUS Pierantoni, 1902

This is normally a marine genus, but it provides yet another example of a marine incursion into the St. Lawrence Great Lakes.

1. P. hallae Cook & Hiltunen, 1975

Small worms less than 4 mm long. All chaetae are alike to XIX, 3-5 bifids per bundle with the upper teeth shorter and thinner than the lower; between XX and XXII the upper teeth of the dorsal chaetae become reduced until only simple pointed chaetae are present from there on. The ventral chaetae become simple pointed from XXX on. Penial chaetae on XI, 3-6 simple pointed, hooked chaetae on each side, with short distal ends. The broad, muscular atria bear 2 prostates each and end in non-retractile porophores, behind which are deep folds which include the tips of the penial chaetae. The spermathecal pores are lateral, there are no spermatozeugma.

Lake Huron, Lake Superior.





## LUMBRICULIDAE

These interesting worms have received very little attention by authors other than S. Hrabě. Many species are restricted to ground water habitats, and unusual forms have been found in caves. Histological sections of mature forms are most important tools for the identification of these worms, but some can be identified without.

The very plastic, parthenogenetic and asexually reproducing forms in Lumbriculus have caused considerable debate about exact limits in the genus. Specific criteria in Trichodrilus are narrow, as it has become traditional to expect endemism in cavernicolous animals, and every attempt seems to be made to confirm it.

Many of the genera named by Holmquist (1976) are regarded as subgenera here.

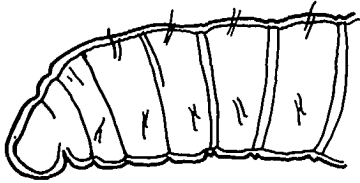

no proboscis

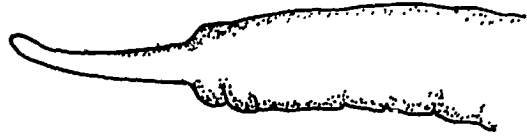

unsegmented proboscis

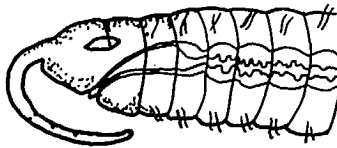

pseudosegmented proboscis

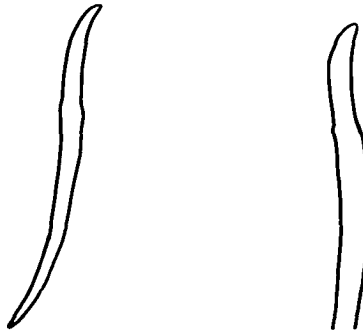

simple pointed  
chaetae



bifid chaeta

## LUMBRICULIDAE

### Separation of Primary Groups

- |   |         |       |
|---|---------|-------|
| 1. Prostomium terminating in a pseudo-segmented proboscis, chaetae bifid anteriorly (even if teeth small, obscure) but may be simple pointed posteriorly. | Group 1 | p.213 |
| 2. Prostomium terminating in a proboscis without pseudosegmentation, chaetae simple pointed.  | Group 2 | p.215 |
| 3. Prostomium lacking a proboscis, chaetae bifid.   | Group 3 | p.217 |
| 4. Prostomium lacking a proboscis, chaetae simple pointed.  | Group 4 | p.219 |

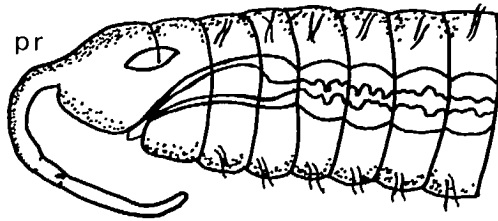
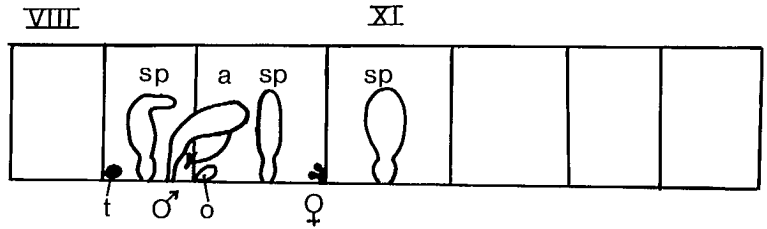
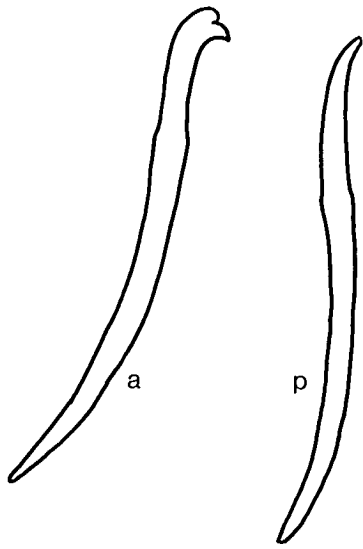

*K. hexatheca*

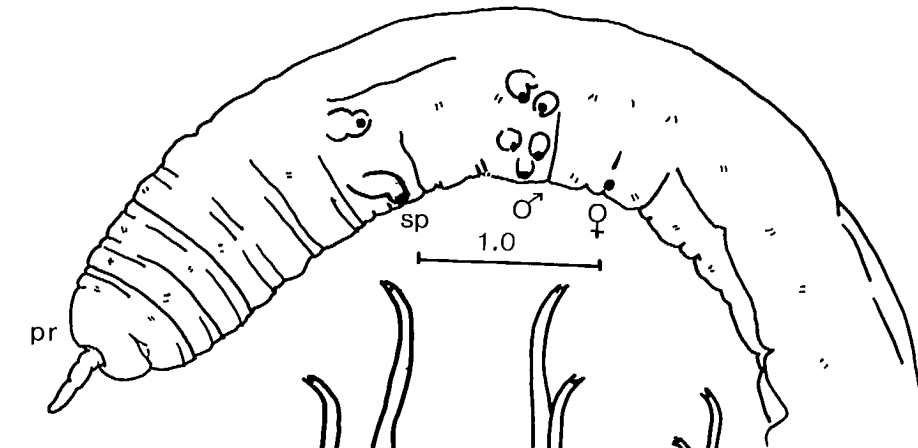
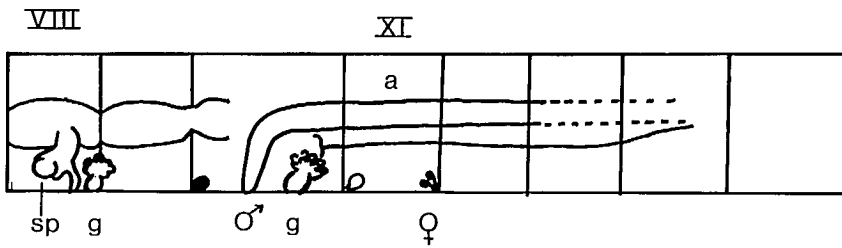

*R. brooksi*

## LUMBRICULIDAE

### GROUP 1

There are only two species in this group, Rhynchelmis brooksi known from Alaska, and Kincaidiana hexatheca from British Columbia, Washington and Oregon. The following characteristics should suffice to separate immature specimens. Characters based on reproductive structures will be described under the generic descriptions.

1. Proboscis elongate. Chaetae bifid in a few anterior segments. Pacific Northwest.

Kincaidiana hexatheca p.223

2. Proboscis short. Chaetae appear simple pointed in usual lateral view, but actually bifid with two colateral teeth\*.  
Alaska.

Rhynchelmis brooksi p.225

\* These are not well illustrated in the original, but should be recognizable.

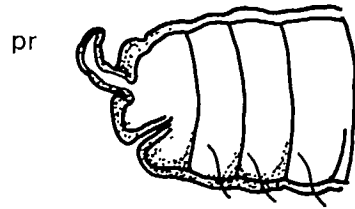
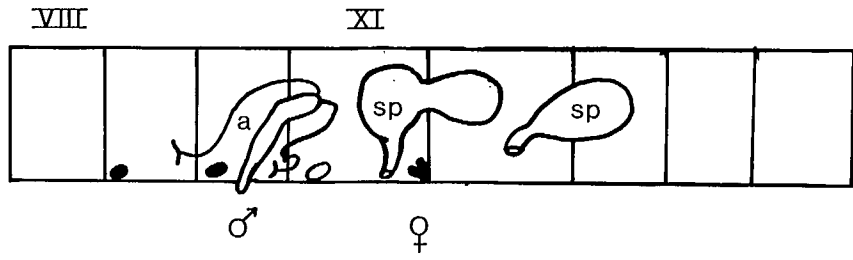

T. allegheniensis

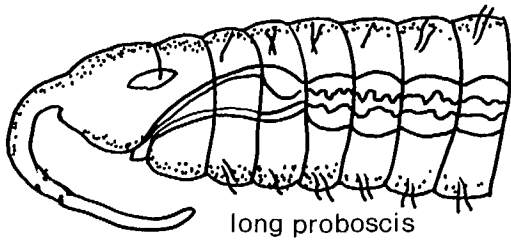

long proboscis

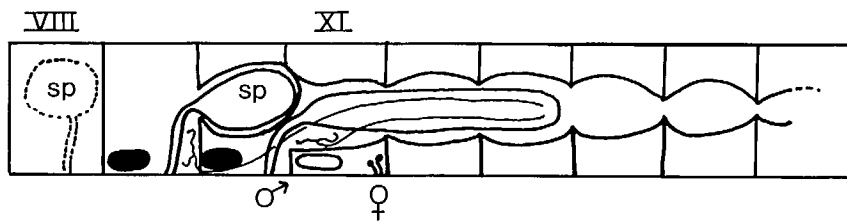

Eclipidrilus

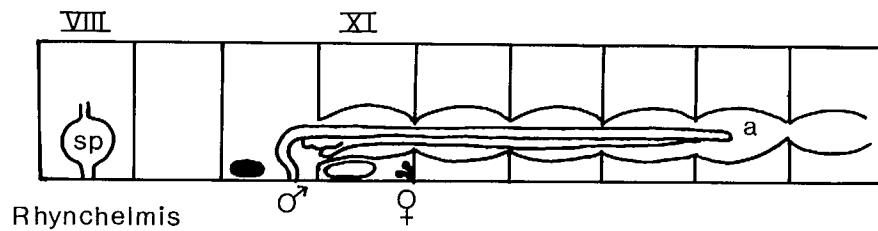

Rhynchelmis

## LUMBRICULIDAE

### GROUP 2

Species with a non-segmented proboscis and simple pointed chaetae:

1. Cave dwelling species. Short proboscis. Atria elongate cylindrical, as long as body width, in X. Spermathecae in both XI and XII.  
Trichodrilus allegheniensis p.231
2. Surface water species. Long proboscis. Atria much longer than body width, with layers of spiral muscles, in X. Spermathecae in IX.  
Eclipidrilus (A) p.233
3. Surface water species. Long proboscis. Atria much longer than body width, without spiral muscles, in X. Spermathecae in VIII.  
Rhynchelmis p.225



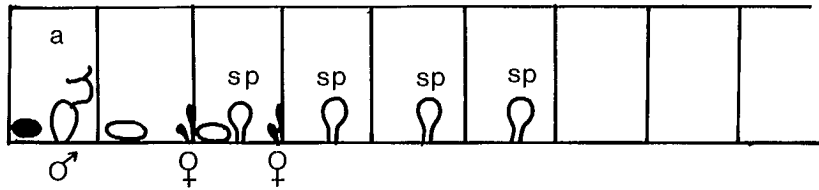
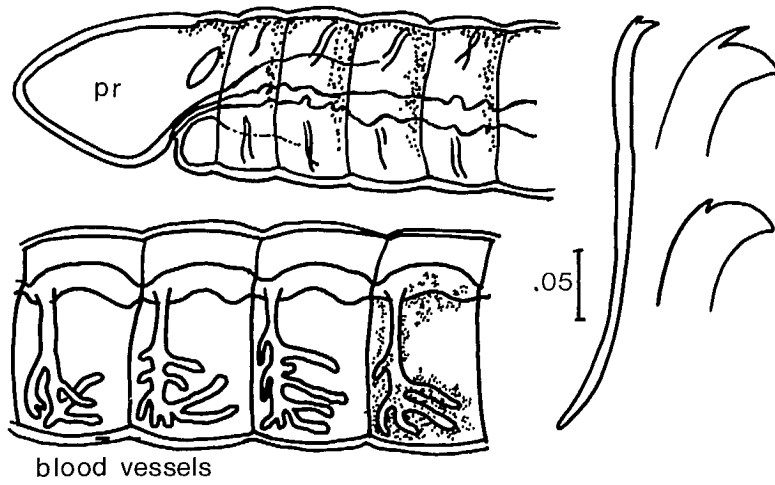

L. variegatus

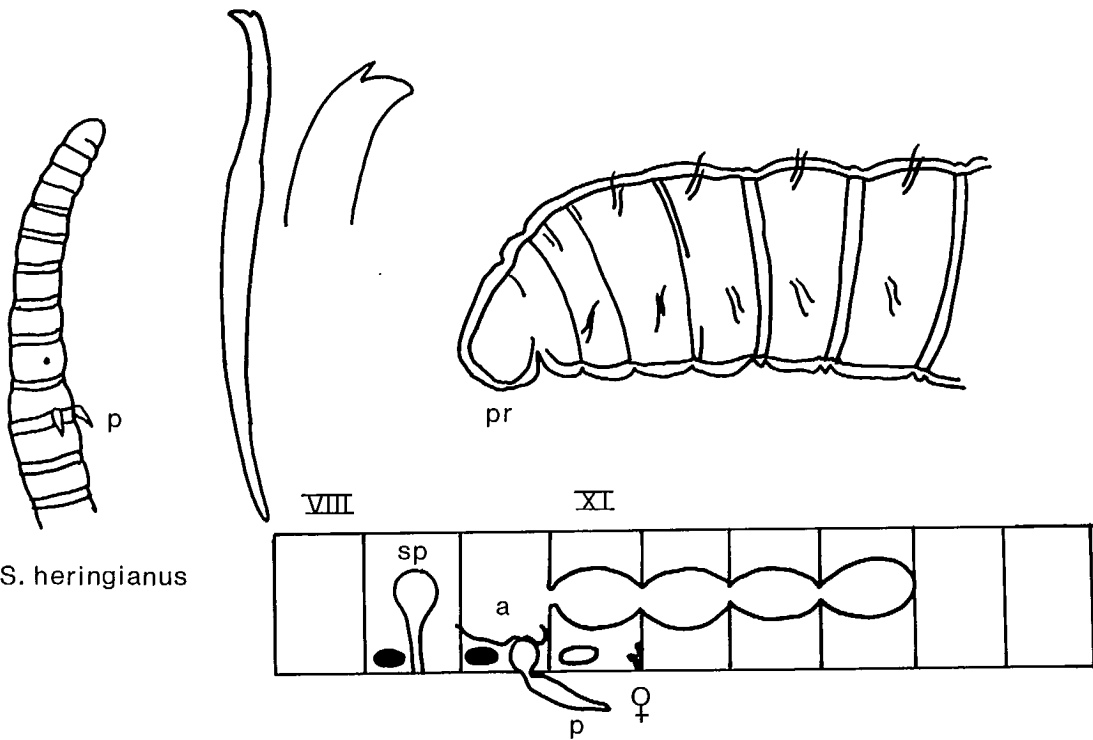

S. heringianus

LUMBRICULIDAE

GROUP 3

Species with no proboscis, but with bifid chaetae:

1. Elongate, cylindrical worms that readily fragment. Dark red colour in life, often with green tinge anteriorly. Posterior blood vessels with branched lateral vessels. Sexual specimens with number and position of organs variable, but spermathecae in a number of post atrial segments. No permanently everted penes.

Lumbriculus

p.237

2. Short tapering worms that do not readily fragment, but which resemble tubificids. Pale coloured in life, no green tinge. Posterior blood vessels with short unbranched lateral pouches. Sexual specimens with spermathecae paired in IX, atria in X, with thin, tapering permanently everted penes close together ventrally.

Stylodrilus heringianus

p.243

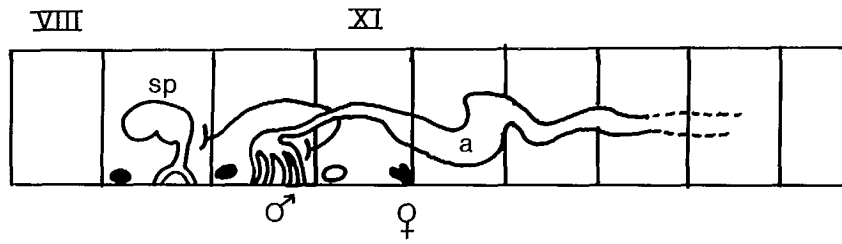

*S. multiporus*

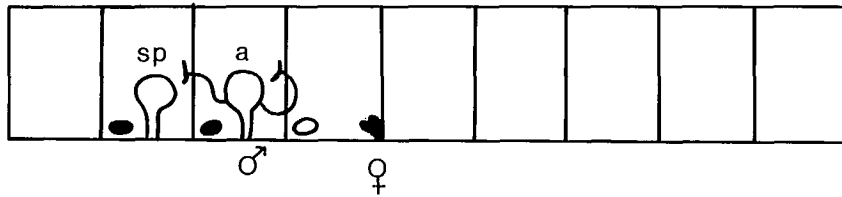

*S. beattiei*

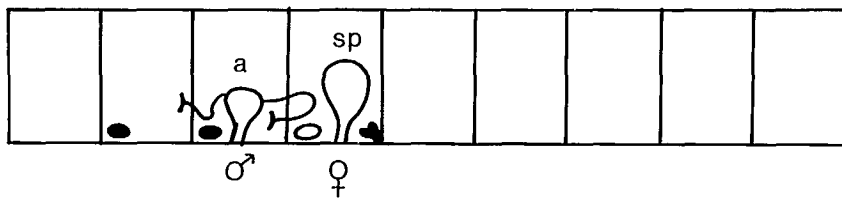

*T. culveri*

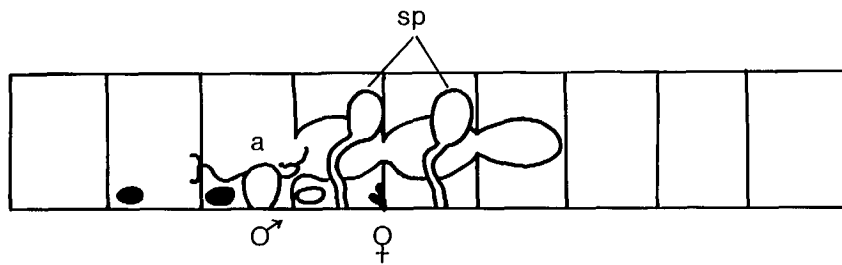

*T. allobrogum*

## LUMBRICULIDAE

### GROUP 4

Species without a proboscis but with simple pointed chaetae. The ten species in this group have quite limited distributions. It is convenient to divide them into two groups:

- |                           |         |       |
|---------------------------|---------|-------|
| 1. Ground water species.  | Group A | below |
| 2. Surface water species. | Group B | p.221 |

#### (A) Ground water Species.

- |  |                                 |       |
|--|---------------------------------|-------|
| 1. Four pairs of male pores on X, two pairs of spermathecal pores on IX.<br>Virginia.                  | <u>Spelaedrillus multiporus</u> | p.245 |
| 2. Male pores paired on X, spermathecal pores paired on IX.<br>West Virginia.                          | <u>Styloedrillus beattiei</u>   | p.243 |
| 3. Male pores paired on X, spermathecal pores paired on XI.<br>West Virginia.                          | <u>Trichodrillus culveri</u>    | p.231 |
| 4. Male pores paired on X, spermathecal pores paired on both XI and XII.<br>Illinois, Washington, D.C. | <u>Trichodrillus allobrogum</u> | p.231 |

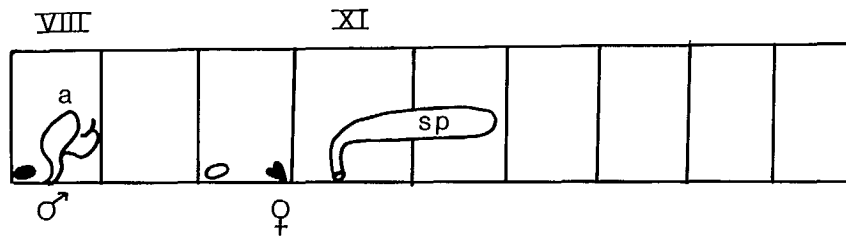

*S. opisthothecus*

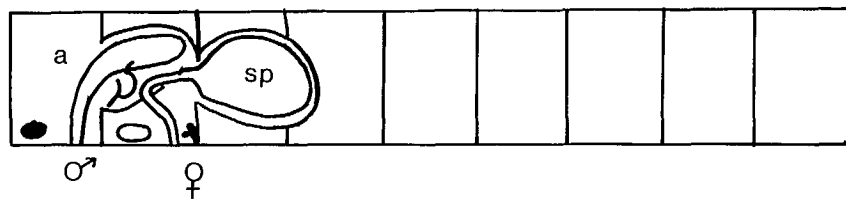

*K. freidris*

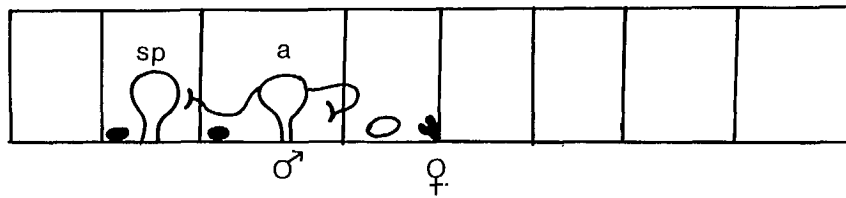

*S. sovaliki*

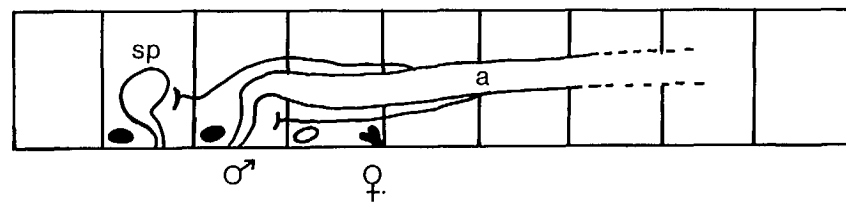

*Eclipidrilus*

Lumbriculidae Group 4 (continued)

(B) Surface Water Species

1. Male pores paired on VIII, spermathecal pores on XI. Atria tall, but within male segment. Testes in VIII, ovaries in X.  
Alaska.  

Styloscolex opisthothecus p.247
2. Male pores paired on VIII, spermathecal pores on IX. Atria elongate extending beyond male segment. Testes in VIII, ovaries in IX.  
California.  

Kincaidiana freidris p.223
3. Male pores paired on X, spermathecal pores on IX. Atria oval, within male segment. Testes in IX, X, ovaries in XI.  
Alaska.  

Stylodrilus sovaliki p.243
4. Male pores single or paired on X, spermathecal pores single on VIII and IX, or single on IX, or paired on IX. Atria very elongate, extending well beyond male segment (covered with spiral muscles). Testes in IX and X or just X, ovaries in XI.  

Eclipidrilus (B) p.245

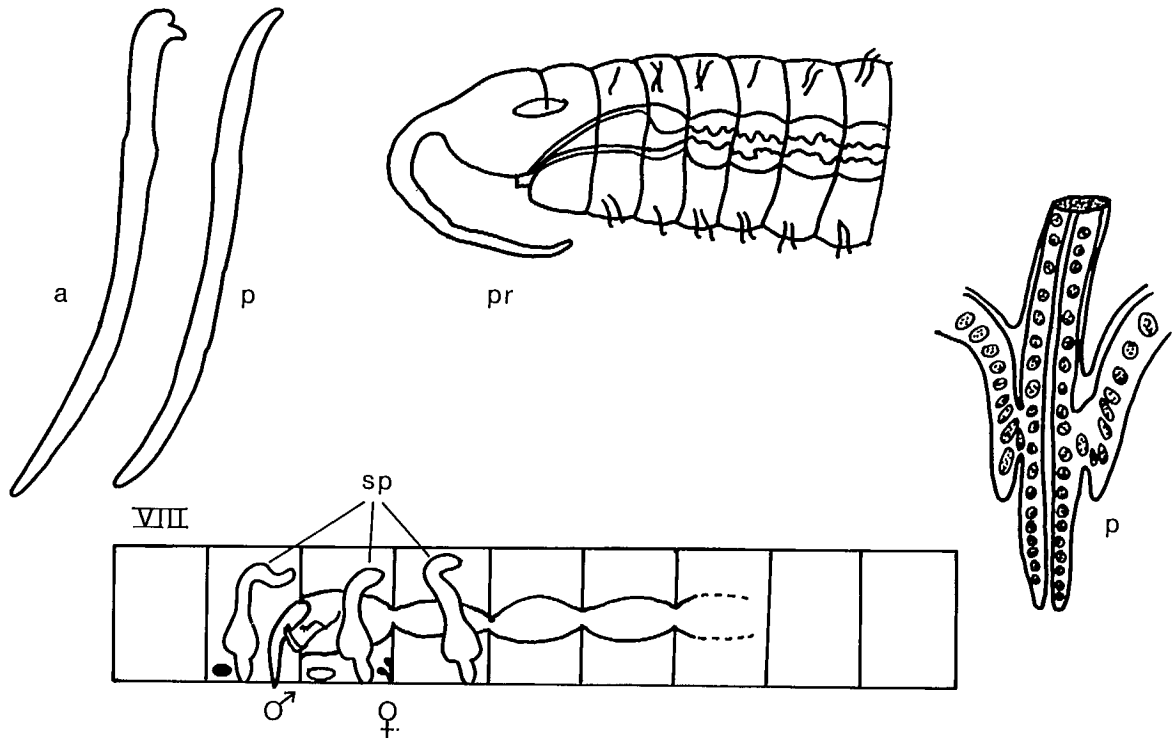

*K. hexatheca*

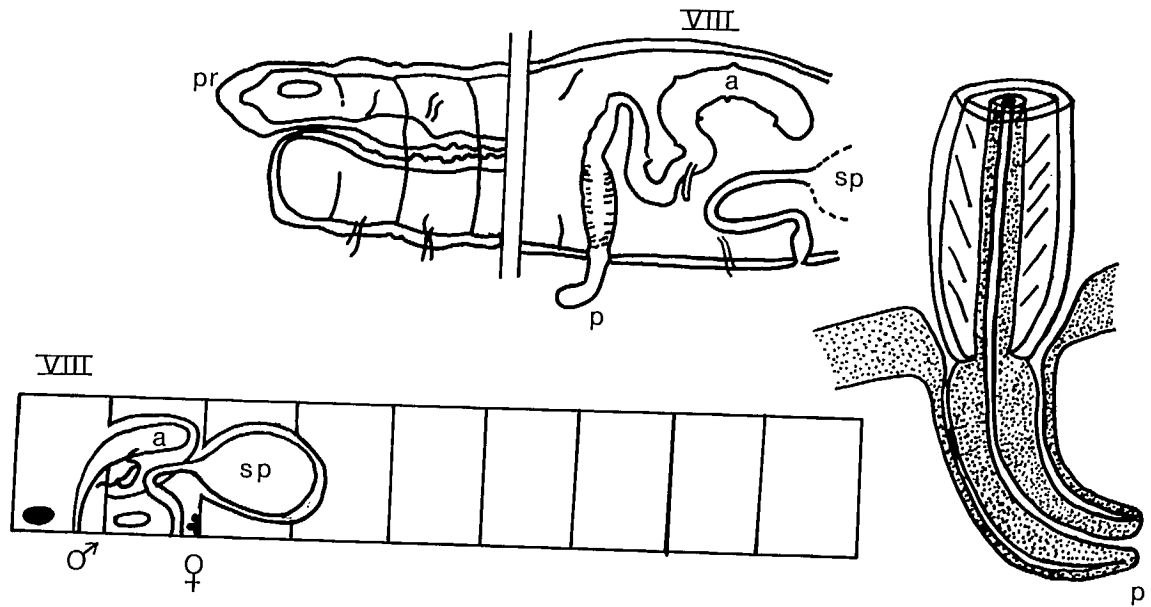

*K. freidris*



KINCAIDIANA Altman, 1936

Both species in this genus are limited to western North America.

1. K. hexatheca Altman, 1936

Worms up to 50 mm long. Prostomium with a long proboscis, pseudosegmented. Chaetae 300 um long, unusual in that they are bifid anteriorly for a few segments, simple pointed posteriorly. The male pores are on IX, the spermathecal pores on IX, X, XI. There are a single pair of testes in IX and ovaries in X. The atria are elongate pear shaped within the male segment, with clumped prostate glands. The penes are protrusible, on porophores.

British Columbia, Washington, Oregon.

2. K. freidris Cook, 1966

Worms up to 12 mm long. No proboscis. Chaetae simple pointed, 90 um. Male pores on VIII, spermathecal pores on IX. Testes in VIII, ovaries in IX. The atria are elongate extending into posterior segments, tubular, with clumped prostate glands. Penes large, protusible.

California (Lake Tahoe and surroundings, ?Fort Bragg).



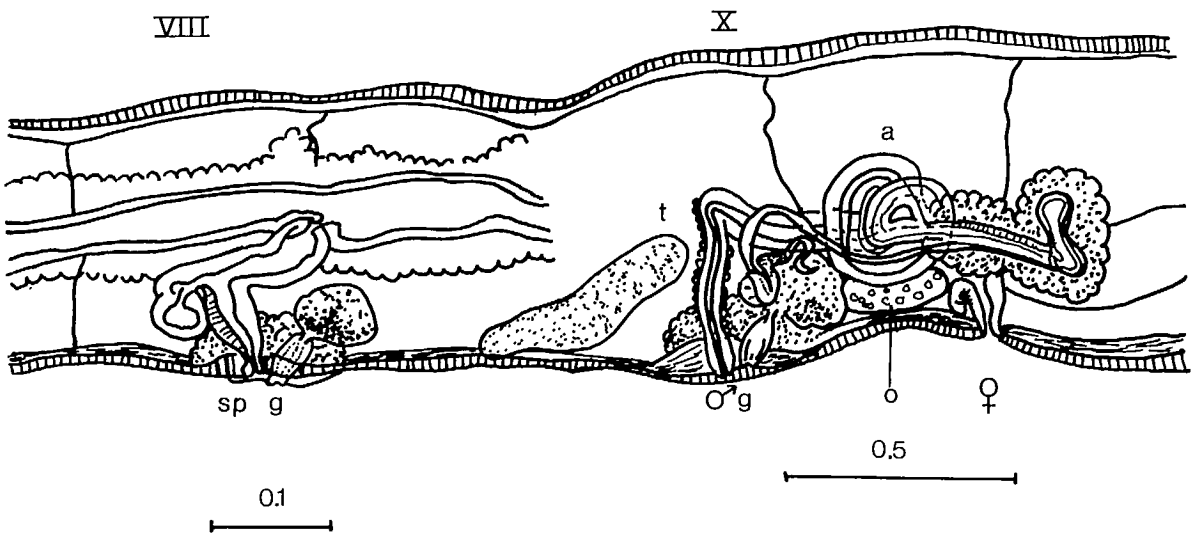
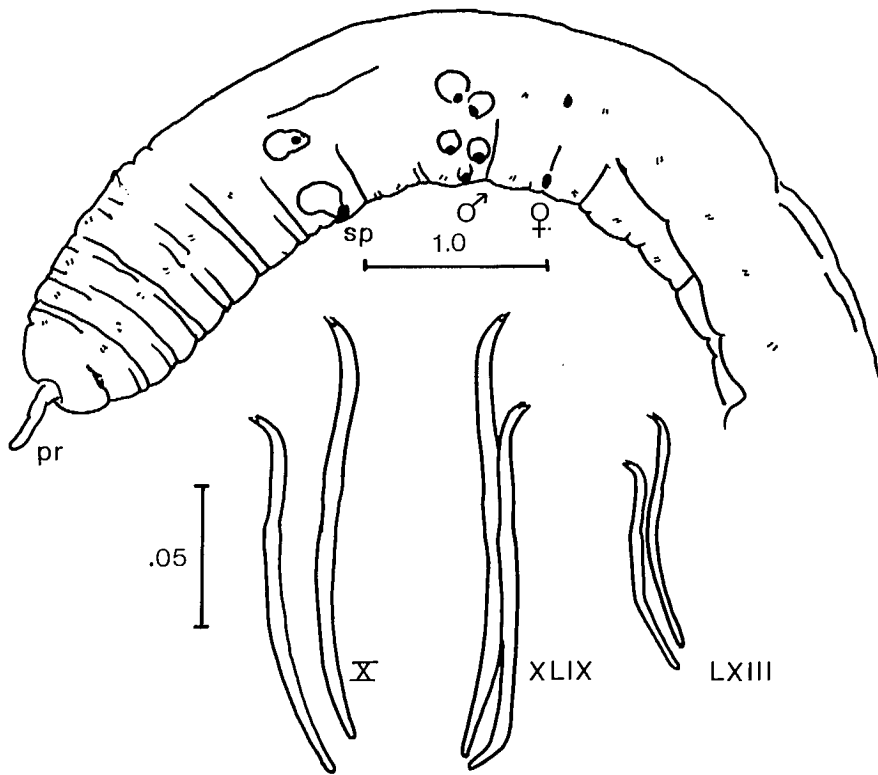

*R. brooksi*

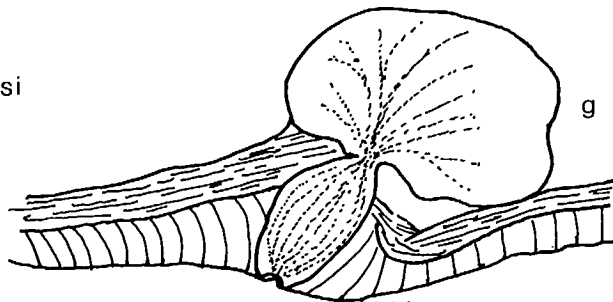

RHYNCHELMIS Hoffmeister, 1843

This genus may require re-evaluation as some of the synonymies claimed in earlier accounts have been challenged by Holmquist (1976). Each of the potential species will be described here, so that collectors can check their own material. Reference to original sources is recommended.

(A) Species with bifid chaetae:

1. R. brooksi Holmquist, 1976

Worms 28 mm long. Prostomium with thin, pseudosegmented proboscis. Chaetae unique, with 2 subequal teeth more or less colateral, so that they appear simple pointed in the lateral view. Spermathecal and male pores in VIII and X, respectively (spermathecal pores variable on VII/VIII on some worms). A pair of testes in X, a pair of ovaries in XI. Long, coiled atria extend from X to as far as XIII, only ventral part covered with prostate gland. No penes. Spermathecae with anterior diverticulum, connect with gut.

Northern Alaska.

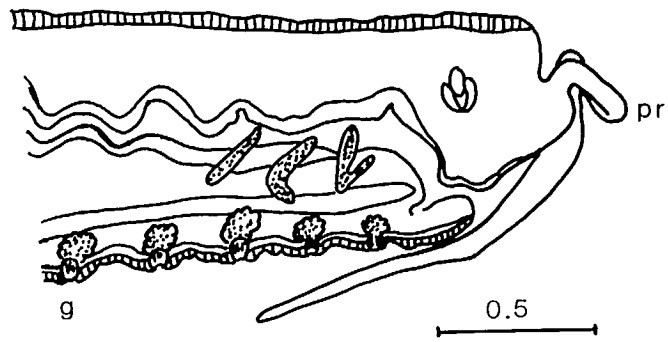

ventral glands

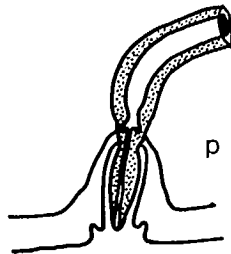

*R. elrodi*, *R. glandula*

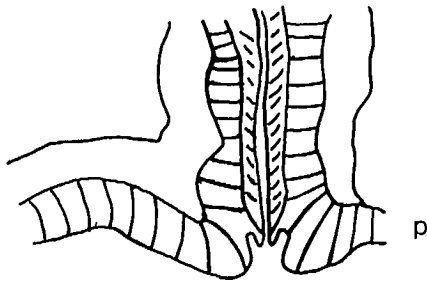

*R. alaskana*

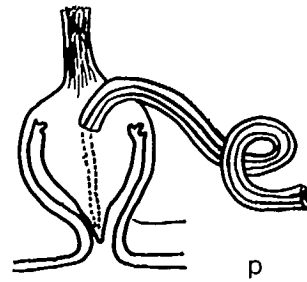

*R. rostrata*

Rhynchelmis (continued)

(B) Species with simple pointed chaetae:

1. No median glands in anterior segments. Penes finger-like. Spermathecae connect to gut.  
Northwestern North America, possibly Northwest Territories.  
R. elrodi p.229
2. Species with median ventral glands in anterior segments. Penes finger like. Spermathecae connect to gut.  
Washington, Idaho.  
R. glandula p.229
3. Species with median ventral glands in anterior segments. Penes are small papillae. Spermathecae not connected to gut.  
Alaska.  
R. alaskana p.229
4. No median ventral glands in anterior segments. Penes bulbous. Spermatheca (single) connects to gut.  
California, Nevada.  
R. rostrata p.229

Species 2 and 3 may be variants of species 1 (see page 229).

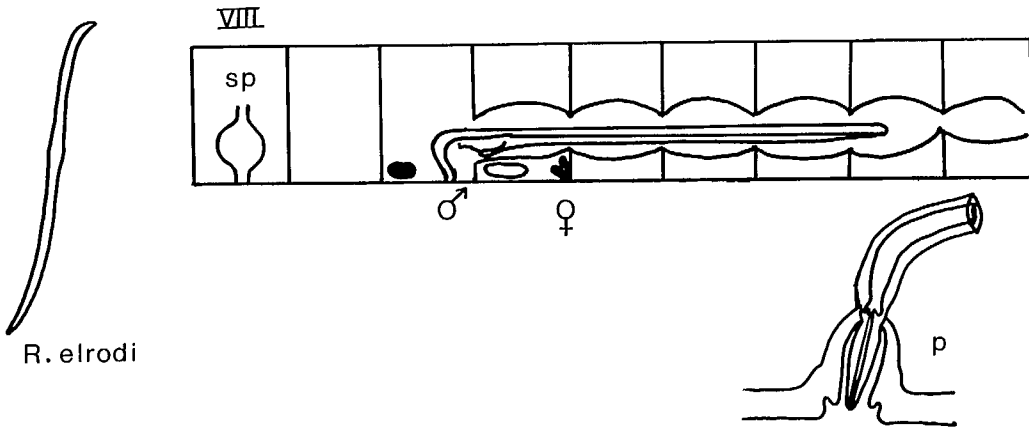

R. elrodi

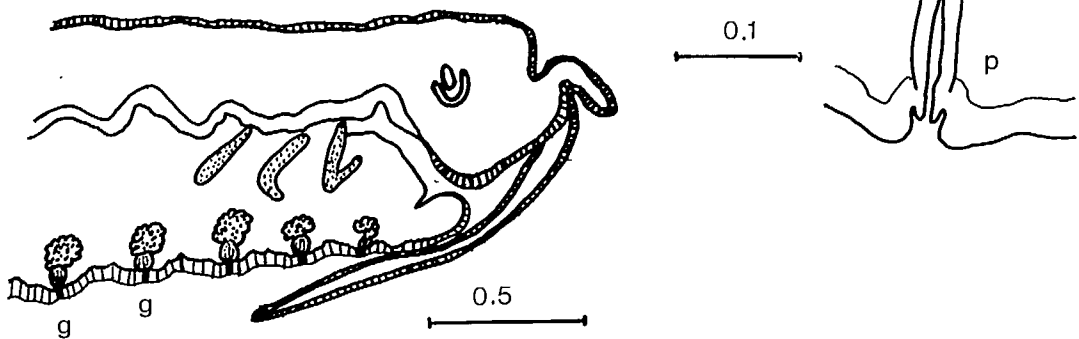

R. glandula

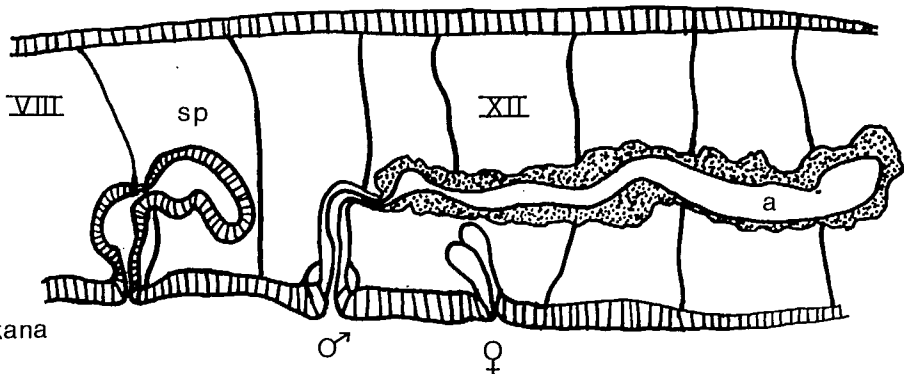

R. alaskana

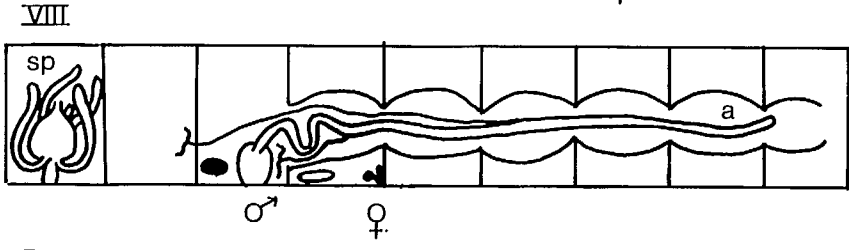

R. rostrata

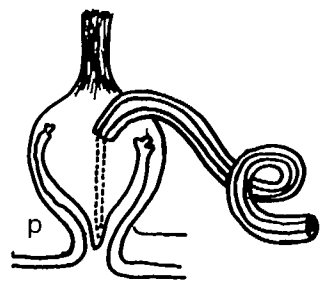

Rhynchelmis (continued)

1. R. elrodi Smith & Dickey, 1918

Worms up to 100 mm long. Prostomium with elongate proboscis. Chaetae simple pointed, 250 um long. Spermathecal pores on VIII, male pores on X. A pair of testes in X, ovaries in XI. Atria long, with a thin muscle layer, only one pair of funnels and vasa deferentia. Penes narrow, long. The spermathecae connect to the gut.

Apparently from Alaska, Wyoming, Montana, British Columbia and possibly Northwest Territories. The North Carolina record, reported by Brinkhurst & Cook (1966), was based on material labelled ?R. orientalis and needs confirmation.

2. R. glandula (Altman, 1936)

This species closely resembles R. elrodi apart from the presence of median ventral glands in (II) III-VII (VIII).

Washington, Idaho.

3. R. alaskana Holmquist, 1976

This species too is close to R. elrodi and R. glandula. It has median ventral glands in II-VIII, but has no connection between the spermathecae and the gut. The penes are small papillae. The prostate covers less of the atrium in this species than in the other two according to Holmquist (1976), and the ventral glands are constructed differently. These glands are only visible in fully mature specimens.

Northern Alaska.

The asiatic R. orientalis Yamaguchi has a vestigial anterior pair of male funnels, but is otherwise close to R. elrodi and R. alaskana.

4. R. rostrata (Eisen, 1888)

Worms to 70 mm long. Prostomium with a proboscis. Chaetae thin, needle like, 250 um long. Spermathecal pore single, median on VIII, male pores paired on X. A pair of testes in X, ovaries in XI. Atria long, with 2 pairs of vasa deferentia and funnels, and large penes in bulbous sacs. Single spermatheca with digitiform diverticulae at ampulla base.

California, Nevada.

Eisen described this as the type species of Sutroa, based on the form and singularity of the spermatheca. The second species (S. alpestris Eisen) is considered synonymous with the type.

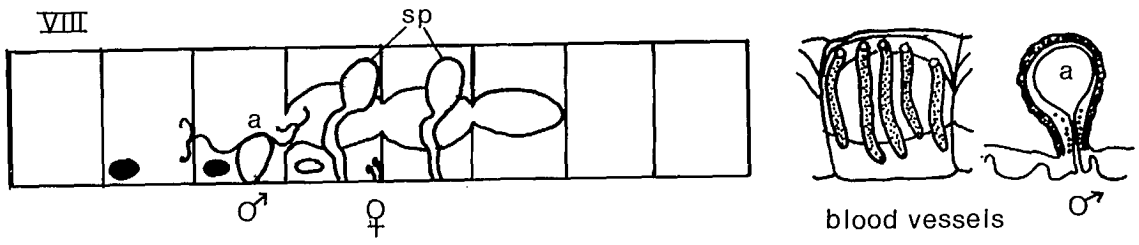

*T. allobrogum*

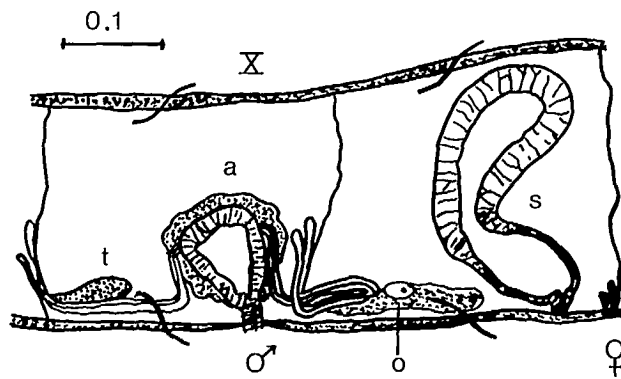

*T. culveri*

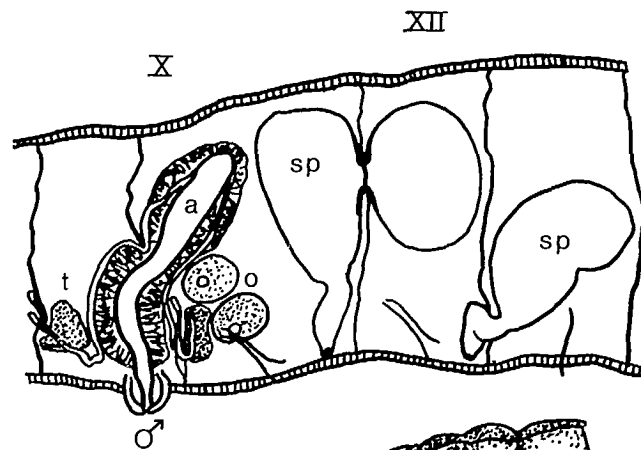

*T. allegheniensis*

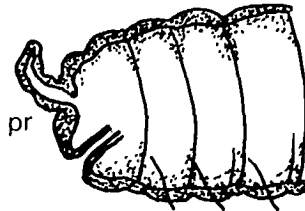

TRICHODRILUS Claparede, 1862

The genus consists mostly of small unpigmented worms with slender needle like sigmoid chaetae. Most occupy ground water habitats and have limited geographic distributions, though there is a tendency in Europe to describe each find as a new species. Only three species are reported from North America to date.

1. T. allobrogum Claparede, 1862

Worms 20-30 mm long. Chaetae 170 um long. Male pores on X, spermathecal pores on XI, XII. Atrial muscle layer thin, atria pear shaped. Penes small, eversible.

Illinois, Washington D.C., in wells. Not seen since 1917.

There should be 3-5 pairs of posterior lateral blood vessels, according to European descriptions.

2. T. culveri Cook, 1975

Worms 14 mm long. Chaetae to 110 um long. Male pores on X, spermathecal pores on XI. Atrial muscle layer thin, atria pear shaped. Penes absent. Posterior lateral blood vessels absent.

West Virginia.

3. T. allegheniensis Cook, 1971

Worms 20 mm long. Chaetae up to 200 um long. A short proboscis is present in this species, unlike the others. Male pores on X on porophores, spermathecal pores on XI, XII. Atria elongate, extending to XI, muscle layer thin. Posterior lateral blood vessels absent.

Tennessee.



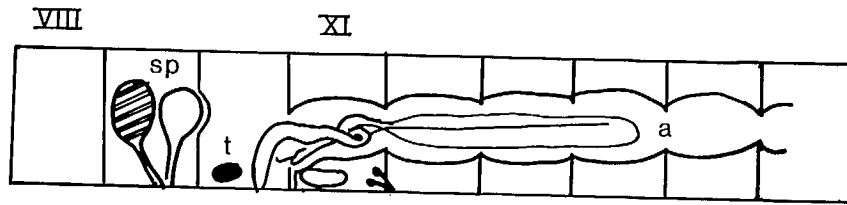

*E. asymmetricus*

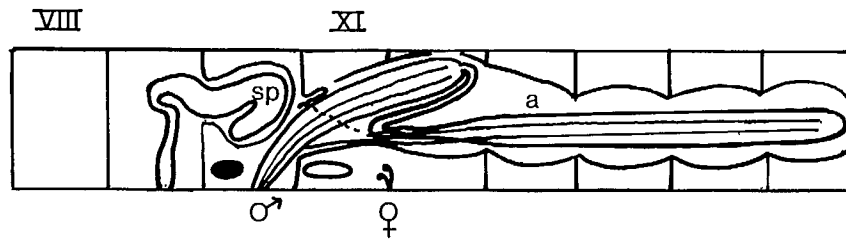

*E. palustris*, *E. daneus*

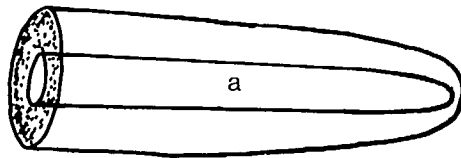

*E. palustris*

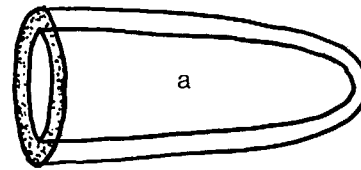

*E. daneus*

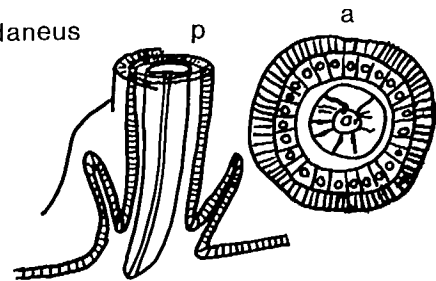

ECLIPIDRILUS Eisen, 1881

This genus has been reviewed by Wassell (1984) who recognized three subgenera, E. (Eclipidrilus) Eisen, 1881, E. (Premnodriulus) Smith, 1900, and E. (Leptodrilus) Wassell, 1984. As the possession of a proboscis helps recognition but is not unique to any subgenus, I will list the species in the two groups (A,B) used in the key.

(A) Species with a proboscis:

1. E. (Eclipidrilus) asymmetricus (Smith, 1896)

Worms 30 mm long. Male pore median on X, spermathecal pores both median on IX. Testes 1 pair in X. Posterior lateral blood vessels branched. Penes long, eversible.

Illinois (Quiver Lake, Havana, 1896).

Wassell (1984) was unable to find the species in the type locality, and it has not been seen in this century. E. asymmetricus was referred to Mesoporodrilus Smith, 1896 by Holmquist (1976).

2. E. (Premnodrilus) palustris (Smith, 1900)

Worms 50 mm long. Spermathecal and male pores paired on IX and X, respectively. Testes 1 pair in X or 2 pairs in IX and X, but rudimentary anterior vasa deferentia. Penes, surrounded by muscle layer anteriorly which is continuous with longitudinal body wall muscles, thin cuticularized penis sheath present, retractile. Atrial walls thick, lumen 1/3 of the total diameter.

South Carolina, Florida.

3. E. (Premnodrilus) daneus Cook, 1966

Worms 40 mm long. Spermathecal and male pores on IX and X, respectively. Testes 1 pair in X, but rudimentary anterior vasa deferentia. Penes long, retractile, with thin cuticular sheaths. Atrial walls thin, lumen 2/3 of the total diameter.

South Carolina, Louisiana, Montana.

VIII

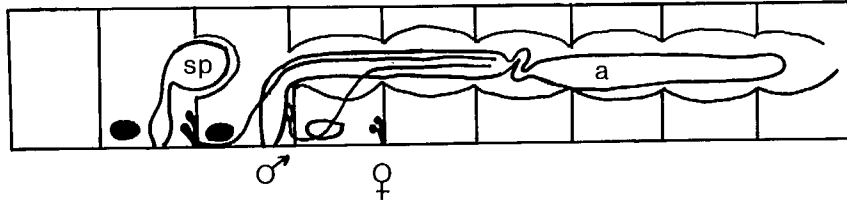

*E. frigidus*

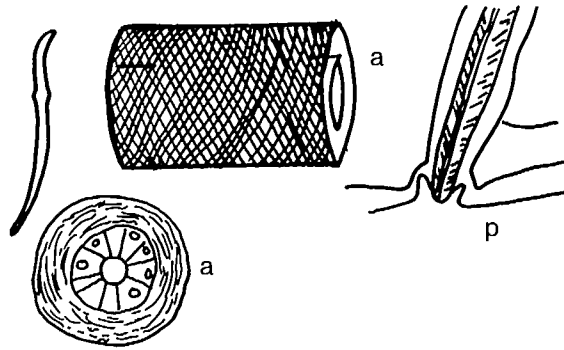
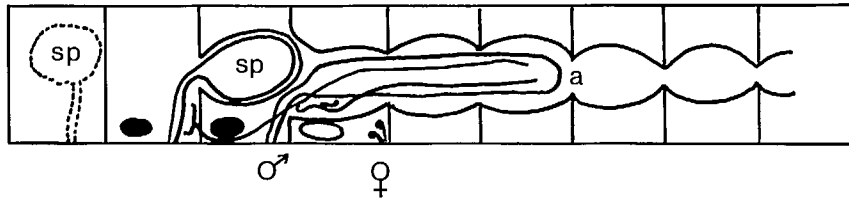

*E. lacustris*

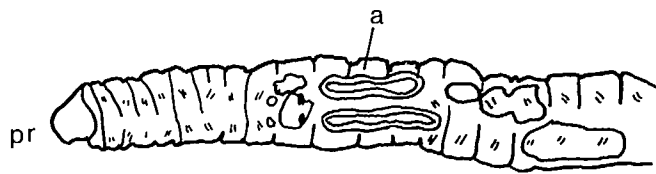

*E. fontanus*

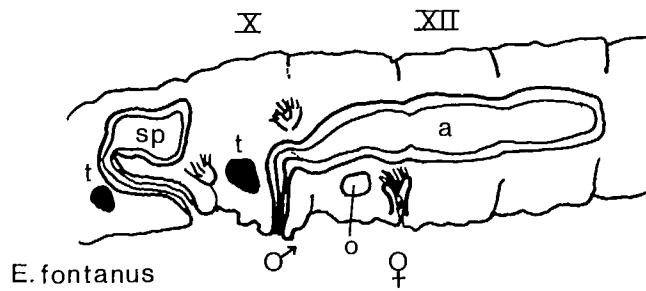

Eclipidrilus (continued)

(B) Species without a proboscis:

1. E. (Eclipidrilus) frigidus Eisen, 1881

Worms 20-30 mm long. Spermathecal and male pores paired on IX and X respectively. Testes paired in IX and X. Penes long, eversible, without cuticular sheath. Atria long, with wide lumen and spiral muscles.

Idaho, California.

The structure previously described as the ectal part of the atrium is now recognized as the large eversible penis.

2. E. (Leptodrilus) lacustris Verrill, 1871

Worms 35-50 mm long. Spermathecal and male pores single, median on IX, X. Testes paired in IX and X. Penes short, protrusible. Atrium large, cylindrical, with 2 pairs of vasa deferentia.

Ontario, Quebec, New York.

This species was referred to Mesoporodrilus Smith by Holmquist (1976).

3. E. (Leptodrilus) fontanus Wassell, 1984

Worms 31 mm long. Spermathecal and male pores on IX, X. Testes in IX and X, or X. Penes small, protusible. Atria long, cylindrical, each with a pair of vasa deferentia.

Pennsylvania.

This species resembles the previous one but has paired reproductive structures. This led Wassell (1984) to reject Mesoporodrilus.

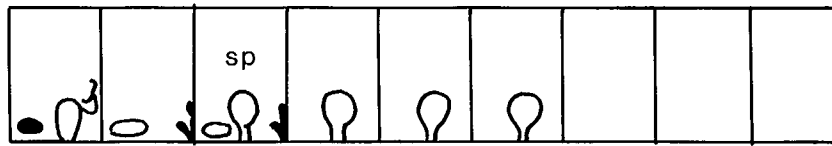

♂      ♀      ♀

one form

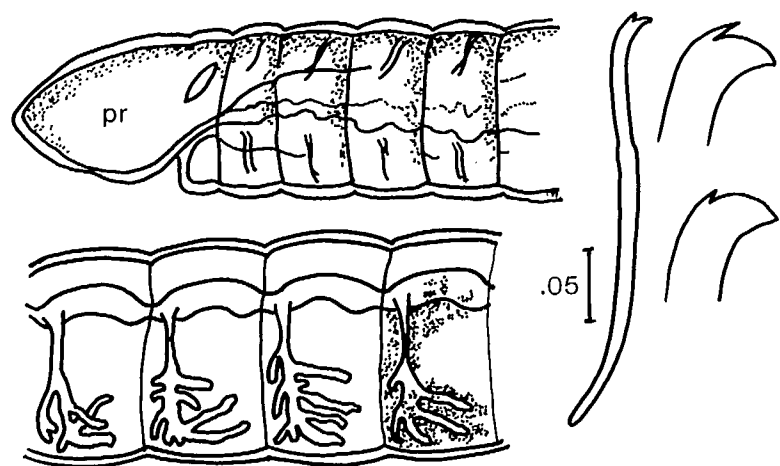

blood vessels

*L. variegatus*

## LUMBRICULUS Grube, 1844

Until recently, it was considered that there was a single species in this genus in North America, the type species Lumbriculus variegatus Muller, 1744. This large worm is common and widespread, and is one of only two lumbriculids to have been distributed beyond the holarctic region. It is common in ponds, lake edges and streams, and may form large populations in mosses and vegetation growing in fish rearing channels. It fragments easily, and is supposedly an asexually reproducing form. Like other parthenogenetic lumbriculids, the sexual forms, quite scarce in this species, show considerable variability in the number and placement of the reproductive organs. The atria can be found, paired or unilaterally, in segments VII-X in the type species, with the majority having a pair in VIII. The typical condition is a single pair of atria, a single pair of testes, and a single pair of vasa deferentia and funnels. There are usually four pairs of spermathecae, beginning one or two segments behind the atrial segment. The asexual forms can be identified by their long, parallel-sided bodies and the branched lateral blood vessels on the posterior end, as well as the dark red colour and greenish anterior end, all best seen in live specimens.

Considerable variation in the number and location of the reproductive organs may reflect the change in reproduction habits here, just as in another, better studied lumbriculid, Lamprodrilus mrazeki from Czechoslovakia.

Holmquist (1976) did not find the typical form in Alaska, but reported instead three closely related forms. She elected to re-erect the genus Thinodrillus Smith, 1895 for these, even though this qualifies as a forgotten name (nomen oblitum) so far as I am aware. This is based on the presence of two vasa deferentia per atrium as there is only one in Lumbriculus. Holmquist claims that her specimens of all three species lacked replicate atria, but quite erroneously comments that the same is true of earlier records, all clearly documented by Cook in Brinkhurst & Jamieson (1971). Lumbriculus variegatus is known to have four testes, four male funnels and two atria in some cases, even if the vasa deferentia were not observed (Mrazek 1907). I retain all these species in one genus, and feel that the specific criteria are not always adequate. The species are:

### 1. L. variegatus (Muller, 1774)

Chaetae about 200 um long. Usually 1 pair of male pores, between VII-X, mostly on VIII. One pair of testes and vasa deferentia, 1 or 2 pairs of ovaries begin behind testes. Spermathecae usually 4 pairs, beginning 1 or 2 segments behind atrial segment.

Widespread.

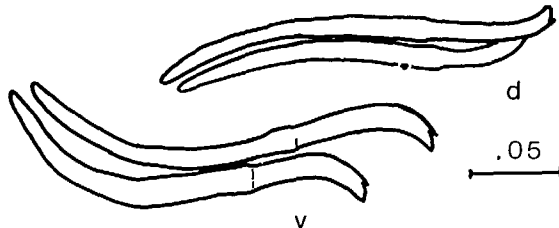
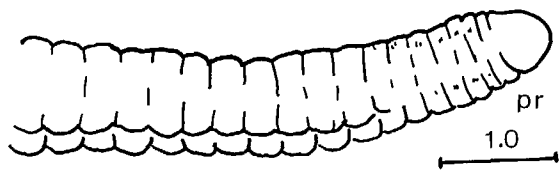

L. inconstans

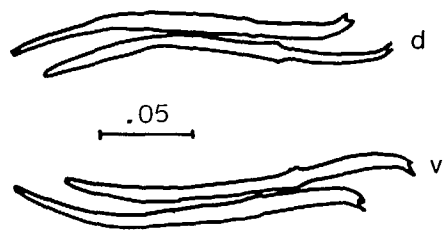
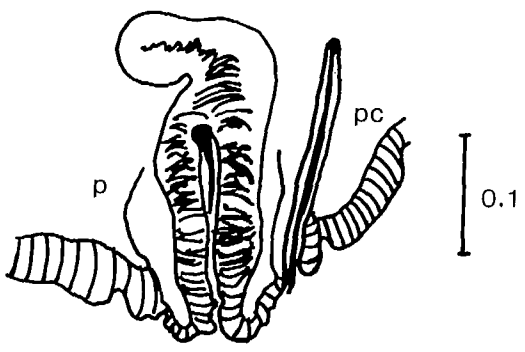
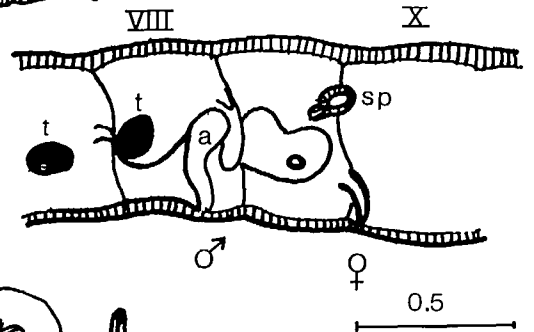
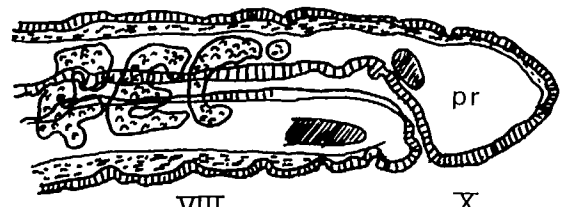

L. ambiguus

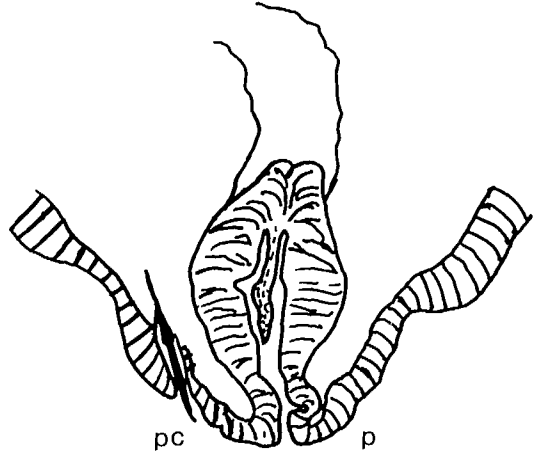
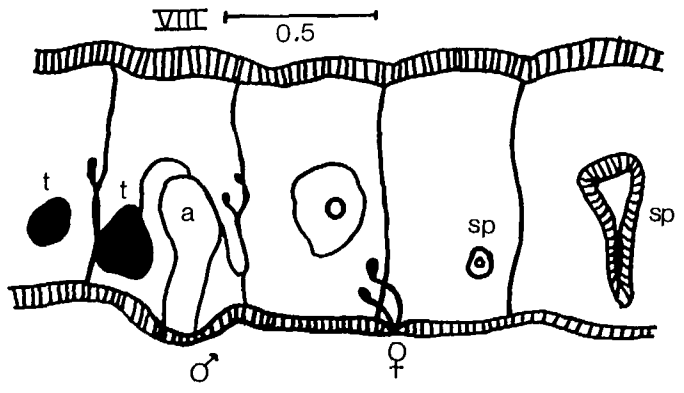

Lumbriculus (continued)

2. L. inconstans (Smith, 1895)

Chaetae about 240 um long. Usually 1 pair of male pores, between VIII-XI, mostly in X. Two pairs of testes and vasa deferentia, 1-3 pairs or ovaries beginning behind the testes. Spermathecae in 1-5 segments behind the atrial segment, vestiges present in atrial segment.

Widespread.

3. L. ambiguus (Holmquist, 1976)

Chaetae about 185 um long. A pair or a single male pore in VII or VIII. Testes from a single unilateral to 2 full pairs, vasa deferentia similarly variable in relation to the single or paired atria, each atrium may bear 1 or 2 male ducts. 1-2 or more pairs of ovaries beginning behind the testes. Spermathecae 1-3 or more, paired or unilateral, beginning behind the atrial segment or beyond.

Alaska.

The distinction from the above is limited to the inconstancy of the reproductive apparatus according to Holmquist, as opposed to the supposed constancy of these elements in the species named inconstans.

D.G. Cook (pers. comm.) suggests that these figures could as well be used to illustrate L. variegatus.



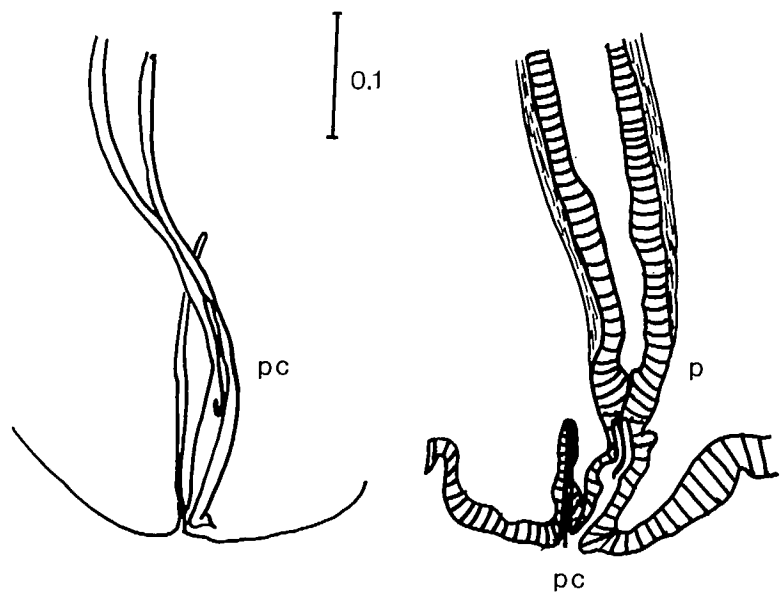
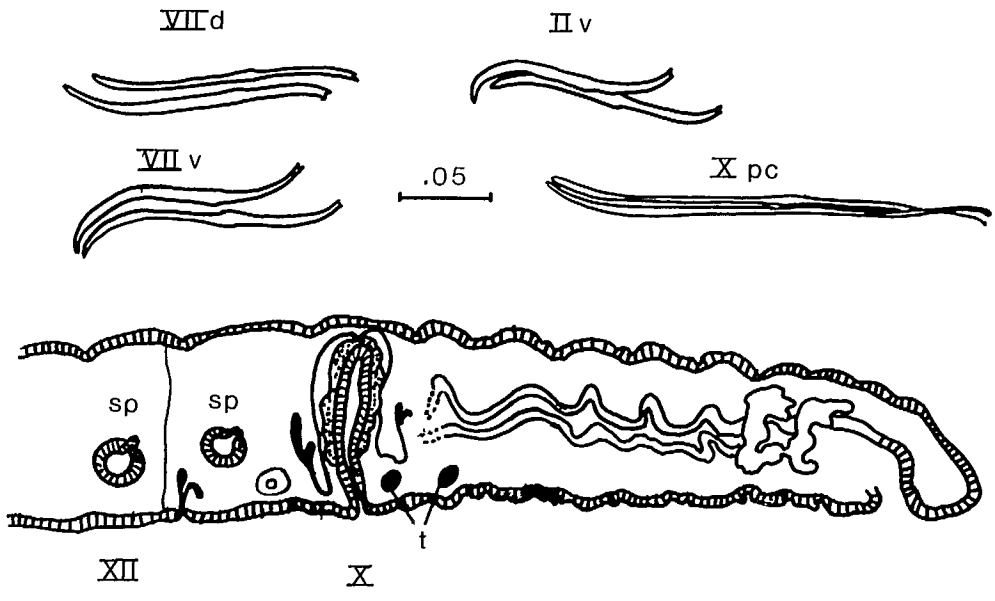

L. genitosetosus

Lumbriculus (continued)

4. L. genitosetosus (Holmquist, 1976)

Smaller worms (to 23 mm long). Chaetae about 140 um long. A pair of male pores usually on X. Testes and male ducts 2 pairs, usually in IX-X. Ovaries paired, usually in XI. Two pairs of spermathecae, in segments following atrial segment. Modified genital chaetae at the male pore, almost straight with thin filiform tips.

Alaska.

The genital chaetae are novel to this description, but while Holmquist (1976) discusses the possible relationship between this and Trichodrilus species (which it resembles only superficially on the basis of segmental position of the reproductive apparatus), the separation of this species from the other Lumbriculus (as Thinodrilus) species is not debated. The genital chaetae could be just another feature lost by the majority of specimens in the genus, which share many details well described by Holmquist (1976), such as the cuticular penes common to them all. There are no other records of genital chaetae in the family.

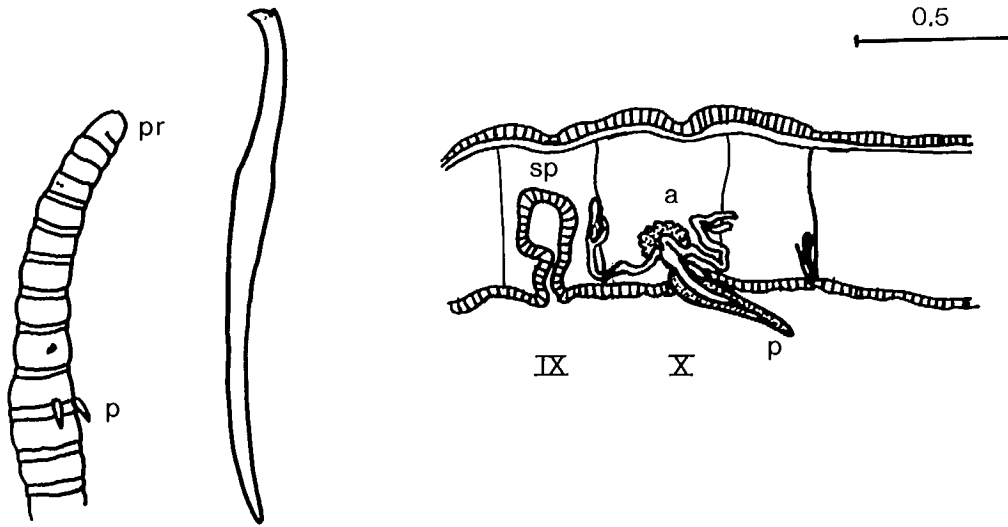

*S. heringianus*

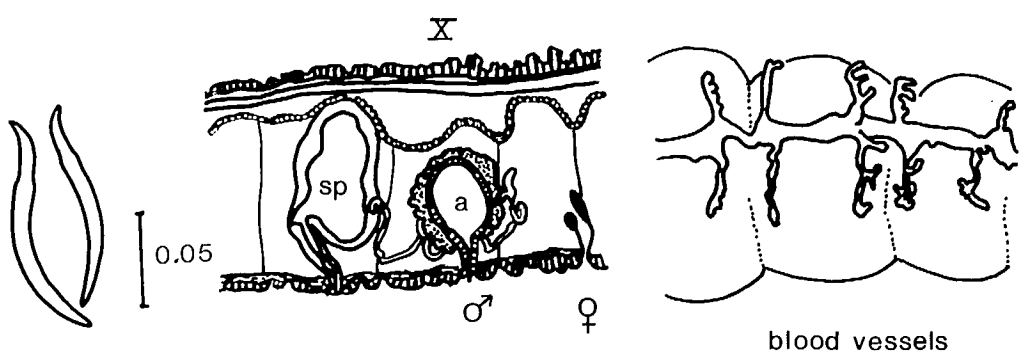
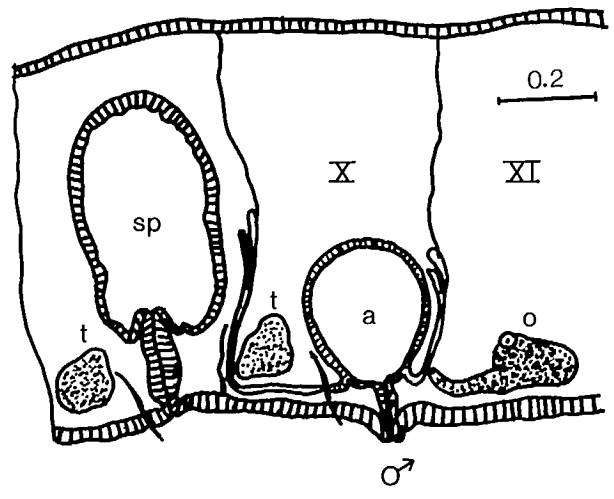

blood vessels

STYLODRILUS Claparede, 1862

There are three American species in this genus, one of which was originally thought to have been introduced from Europe (Stylodrilus heringianus). Although some recent findings of that species have thrown some doubt on that theory, the same species has also been reported from New Zealand. This suggests that it may well be readily distributed by factors such as the aquarium trade, as the whole family is originally holarctic. The secondary annulation of anterior segments should be noted.

1. S. heringianus Claparede, 1962

Worms 25-40 mm long. Chaetae bifid, 160 um long, with short upper teeth. Long (300 um), non-retractile penes on X. Two pairs of short, lateral blood vessels posteriorly.

Widespread, Great Lakes and Canada.

2. S. beattiei Cook, 1975

Worms up to 20 mm long. Chaetae simple pointed, 130-180 um long. Male pores on small superficial papillae on X. No posterior lateral blood vessels.

West Virginia (Tub Cave, Pocohontas County).

3. S. sovaliki (Holmquist, 1976)

Worms 30-40 mm long. Chaetae simple pointed. Male pores on small papillae on X. Lateral blood vessels more or less branching, from XX on.

Alaska, surface waters.

This species closely resembles the European S. absoloni (Hrabe, 1970).

The last two species are associated with the subgenus Bythonomus, still held to be a genus by Holmquist (1976). The supposedly diagnostic features vary widely, recently demonstrated by several workers.

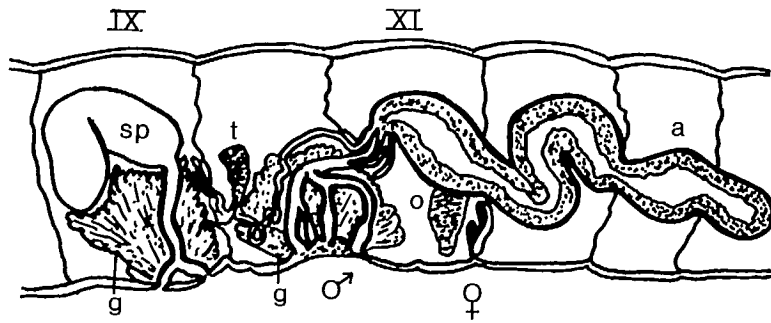
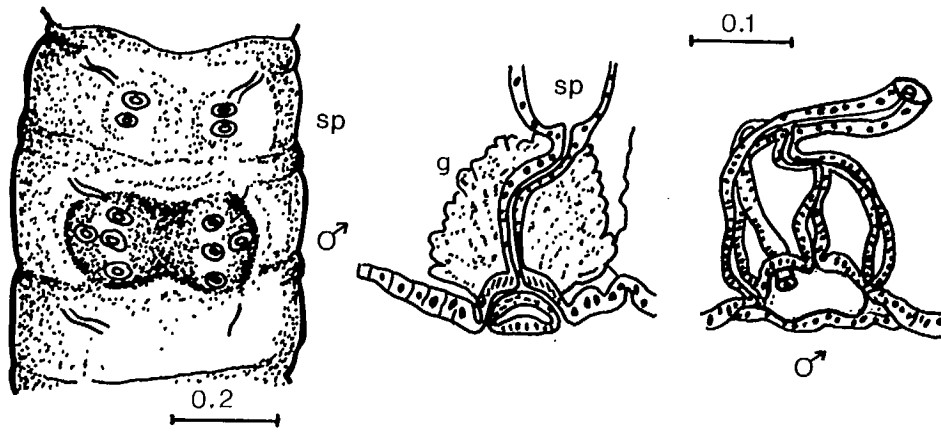

*S. multiporus*

SPELAEDRILUS Cook, 1975

The single species in this genus is known only from the type locality, Smith Cave, Russell County, Virginia.

1. S. multiporus Cook, 1975

Worms about 17.5 mm long. No proboscis. Chaetae simple pointed, 135-160 um long. Male pores 4 pairs on X in a dumbbell shaped depression, two pairs of spermathecal pores on IX. One pair of testes in X, but two pairs of male funnels and vasa deferentia present, ovaries one pair in XI. The atria are elongate, lacking prostates, and each reaches the exterior via 4 ejaculatory ducts. Spermathecal and male pores associated with large glands.  
Virginia.

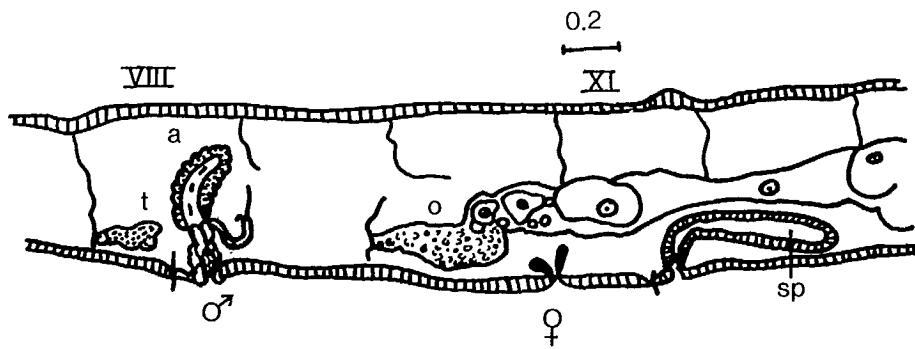
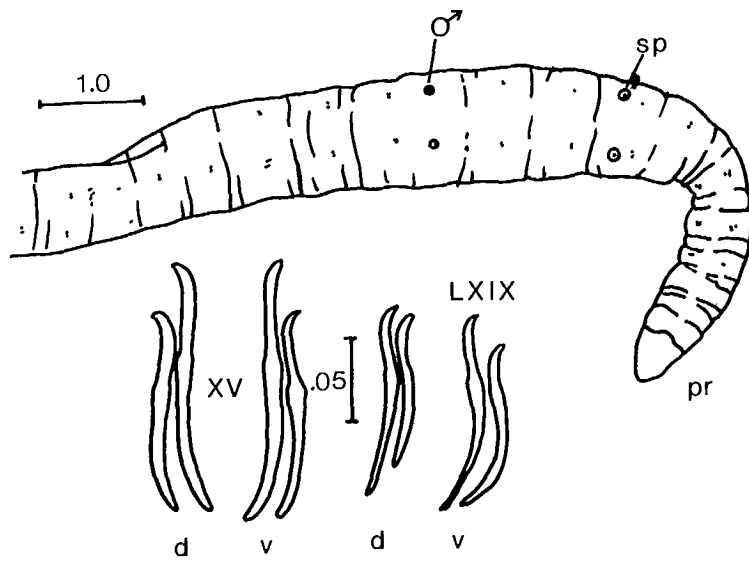

*S. opisthotheucus*

STYLOSCOLEX Michaelsen, 1901

The single North American species in this genus was reported from Alaska in addition to the type locality in Kamchatka; the other species are known from Japan, Manchukuo and Lake Baikal. The genus is unique in that there is an intervening segment between those bearing the single pairs of testes and ovaries. The single species recorded here is the only one without pretesticular spermathecae.

1. S. opisthothecus Sokolskaya, 1969

Worms 40 mm long. No proboscis. Chaetae simple pointed. Male pores on VIII, spermathecal pores on XI. There are a single pair of testes in VIII, ovaries in X. The atria are tubular but extend beyond VIII only into IX if at all. There are long, narrow cuticular true penes.

Northern Alaska.





## REFERENCES

- Barton, D. R., & M. Griffiths. 1984. Benthic invertebrates of the nearshore zone of eastern Lake Huron, Georgian Bay and North Channel. *J. Great Lakes Res.* 10:407-416.
- Brinkhurst, R.O. 1966. A taxonomic revision of the Haplotaxidae. *J. Zool. Lond.* 150:29-51.
- \_\_\_\_\_, 1981. A contribution to the taxonomy of the Tubificinae (Oligochaeta, Tubificidae). *Proc. Biol. Soc. Wash.* 94: 1042-1067.
- \_\_\_\_\_, 1982. Evolution in the Annelida. *Can. J. Zool.* 60:1043-1059.
- \_\_\_\_\_, 1984a. Comments on the evolution of the Annelida. *Hydrobiologia* 109:189-191.
- \_\_\_\_\_, 1984b. The position of the Haplotaxidae in the evolution of oligochaete annelids. *Hydrobiologia* 115:25-36.
- \_\_\_\_\_, 1984c. A revision of the Tubificidae and Lycodrilidae (Annelida, Oligochaeta) known from Lake Baikal. *Can. J. Zool.* 62:494-509.
- \_\_\_\_\_, 1985. Varichaetadrilus minutus (Brinkhurst, 1965) new combination for Psammoryctides (?) minutus (Oligochaeta, Tubificidae). *Proc. Biol. Soc. Wash.* 98:655-656.
- \_\_\_\_\_, & M. T. Barbour. 1985. A new species of Aulodrilus Bretscher (Oligochaeta, Tubificidae) from North America. *Proc. Biol. Soc. Wash.* 98: 931-934.
- \_\_\_\_\_, & K. A. Coates. 1985. The genus Paranais (Oligochaeta, Naididae) in North America. *Proc. Biol. Soc. Wash.* 98:303-313
- \_\_\_\_\_, & D. G. Cook. 1966. Studies on the North American Aquatic Oligochaeta. III. Lumbriculidae and additional notes and records of other families. *Proc. Acad. Nat. Sci. Philad.* 118:1-33.
- \_\_\_\_\_, & D. G. Cook (eds.). 1979. Aquatic oligochaete biology. Plenum Press, New York and London. 529p.
- \_\_\_\_\_, & R. J. Diaz. 1985. Isochaetides columbiensis: new species (Oligochaeta, Tubificidae) from the Columbia River, Oregon. *Proc. Biol. Soc. Wash.* 98: 949-953.
- \_\_\_\_\_, & B.G.M. Jamieson. 1971. Aquatic Oligochaeta of the world. Univ. Toronto Press, Toronto. 860p.
- \_\_\_\_\_, & R. D. Kathman, 1983. A contribution to the taxonomy of the Naididae (Oligochaeta) of North America. *Can. J. Zool.* 61:2307-2312.
- \_\_\_\_\_, & M. J. Wetzel, 1984. Aquatic Oligochaeta of the world: supplement. *Can. Tech. Rep. Hydrogr. Ocean Sci.* 44:1-101.

- Chen, Y. 1944. Notes on naidomorph Oligochaeta of Philadelphia and vicinity. Notul. Nat. 136:1-8.
- Cekanovskaya, O. V. 1962. The aquatic Oligochaeta of the USSR. Opred. Faune S.S.S.R. 78:1-513. (English translation 1981 Amerind. Publ. to New Delhi).
- Cook, D. G. 1975. Cave dwelling aquatic Oligochaeta (Annelida) from the eastern United States. Trans. Amer. Microsc. Soc. 94:24-37.
- Di Persia, D. H. 1975. Sobre algunas especies y un genero de oligoquetos nuevos para Argentina (Tubificidae, Naididae). Comun. Cienc. Cecoal. 4:1-8.
- Harman, W.J. 1973. New species of Oligochaeta (Naididae) with additional records from Oklahoma and Texas. Southwest Nat. 18:151-164.
- \_\_\_\_\_. 1974. The Naididae (Oligochaeta) of Surinam. Zoologische Verhandlungen Uitgegeven Door Het Rijksmuseum Van Natuurlijke Historie Te Leiden 133, 36p.
- \_\_\_\_\_. 1982. The aquatic Oligochaeta (Aeolosomatidae, Opistocystidae, Naididae) of Central America. Southwest Nat. 27:287-298.
- \_\_\_\_\_. & M. S. Loden. 1978. A re-evaluation of the Opistocystidae (Oligochaeta) with descriptions of two new genera. Proc. Biol. Soc. Wash. 91:453-462.
- \_\_\_\_\_. 1979. A rediscovery of Bratislavia bilongata (Chen, 1944) (Oligochaeta, Naididae) in Florida. Trans. Amer. Microsc. Soc. 98:581-583.
- \_\_\_\_\_. , & M. L. McMahan. 1975. A re-evaluation of Pristina longiseta (Oligochaeta, Naididae) in North America. Proc. Biol. Soc. Wash. 88:167-172.
- Hiltunen, J. K. & D. J. Klemm, 1980. A guide to the Naididae (Annelida: Clitellata: Oligochaeta) of North America. United States Environmental Protection Agency Research Reports, Environmental Monitoring Series 600/4-80-031.
- Holmquist, C., 1976. Lumbriculids (Oligochaeta) of Northern Alaska and Northwestern Canada. Zool. J. Syst. 103:377-431.
- \_\_\_\_\_. , 1983. What is Tubifex tubifex (O. F. Muller) (Oligochaeta, Tubificidae)? Zool. Scripta 12:187-201.
- \_\_\_\_\_. , 1985. A revision of the genera Tubifex Lamarck, Ilyodrilus Eisen, and Potamothrix Vejdovsky & Mrazek (Oligochaeta, Tubificidae) with extensions to some connected genera. Zool. Jb. Syst. 112:311-366.
- Hrabe, S. 1981. The freshwater Oligochaeta (Annelida) of Czechoslovakia. Acta. Univ. Carolinae - Biologica 1979:1-167.

- Jamieson, B. G. M. 1981. The ultrastructure of the Oligochaeta. Academic Press, London. 462p.
- Kathman, R. D. 1986. synonymy of Pristinella jenkinsae (Naididae: Oligochaeta). Proc. Biol. Soc. Wash. (In Press).
- Lafont, M., 1981. Description de Pseudochaetogaster longmeri n.g., n.sp. (Oligochaeta, Naididae) des lacs de Longemer et de Gerardmer (Dept. des Vosges, France). Bull. Mens. Soc. Linn. de Lyon 5:27-32.
- Loden, M. S. & W. J. Harman, 1980. Ecophenotypic variation in setae of Naididae (Oligochaeta). In Aquatic oligochaete biology, ed. R. O. Brinkhurst & D. G. Cook, Plenum Press, New York and London. 529p.
- Mill, P. J., 1978. Physiology of Annelids. Academic Press, London. 683p.
- Parker, S. P. (ed.). 1982. Synopsis and classification of living organisms. McGraw Hill, New York. 1232pp.
- Righi, G. 1985. Dois novos Oligochaeta da Amazonia Venezuelana. Papeis Avulsos de Zoologia Sao Paulo 36:23-30.
- Salvini-Plawen, L. v. 1982. A pedomorphic origin of the oligomeric animals? Zool. Scripta 11:77-81.
- Simpson, K. W. & L. E. Abele. 1984. Ripistes parasita (Schmidt) (Oligochaeta: Naididae), a distinctive oligochaete new to North America. Freshwat. Invert. Biol. 3:36-41.
- Smith, M. E. 1985. Setal morphology and its intraspecific variation in Dero digitata and Dero nivea (Oligochaeta: Naididae). Trans. Amer. Microsc. Soc. 104:45-51.
- Sperber, C., 1948. A taxonomical study of the Naididae. Zool. Bidr. Upps. 28:1-296.
- Spencer, D. R., 1978. Pristina acuminata Liang, a naidid oligochaete new to North America. Trans. Amer. Microsc. Soc. 97:236-239.
- Stimpson, K.S., D. J. Klemm, and J. K. Hiltunen. 1982. A guide to the freshwater Tubificidae (Annelida: Clitellata: Oligochaeta) of North America. EPA - 600/ 3 - 82 - 033.
- Strayer, D., 1983. Piguetiella blanci, a naidid oligochaete new to North America, with notes on its relationships to Piguetiella michiganensis and Specaria josinae. Trans. Amer. Microsc. Soc. 102:349-354.
- Valentine, J. W. 1973. Coelomate superphyla. Syst. Zool. 22:97-102.
- Wassell, J.T., 1984. Revision of the lumbricid oligochaete Eclipidrilus Eisen, 1881, with descriptions of three subgenera and Eclipidrilus (Leptodrilus) fontanus n. subg., n. sp. from Pennsylvania. Proc. Biol. Soc. Washington 97:78-85.
- Wiley, E. O. 1981. Phylogenetics. John Wiley and Sons, New York. 439pp.



## NEW TAXONOMIC DECISIONS

While I believe that nomenclatural changes should appear in the primary literature, the production of a key inevitably creates circumstances which require some pre-publication adjustments.

In this text the following emmendations and changes have been made.

### NAIDIDAE

Dero (Aulophorus) lodeni nov. nom. for D. intermedius Loden & Harman (= D. pectinatus Stephenson).

### TUBIFICIDAE

Tasserkidrilus kessleri (Hrabe, 1962), T. superiorensis (Brinkhurst & Cook, 1966) and T. harmani (Loden, 1979) all n. comb. from Tubifex.



INDEX

abbranchiata, Dero (Dero)	75,81
acuminata, Pristinella	99,107
aequiseta, Pristina	67
(alaskana, Rhynchelmis sp. inq.)	227,229
allegheniensis, Trichodrilus	215,231
allobrogum, Trichodrilus	219,231
Allonais	49,85
alpestris, Rhynchelmis (=R. rostrata)	227,229
alpina, Nais	93
(ambiguus, Lumbriculus sp. inq.)	239
(americanum, Bothrioneurum sp. inq.)	201
americana, Amphichaeta	55
americana, Pristina	69
americanus, Aulodrilus	145,193
americanus, Tasserkidrilus (=T. kessleri)	123,147,151
Amphichaeta	43,55
angustipenis, Limnodrilus	167
appendiculata, Slavina	87
Arcteonais	43,71
Arctodrilus	181
asymmetricus, Eclipidrilus (Eclipidrilus)	233
Aulodrilus	191
barbata, Nais	91
barbatus, Psammoryctides	113,155
bavaricus, Potamothrix	129,159
beattiei, Stylodrilus	219,243
bedoti, Potamothrix	115,157
beetoni, Spirosperma	137,185
behningi, Nais	91
bilongata, Bratislavia	99,101
birsteini, Paranais	57
blanci, Piguetiella	47,61
Bothrioneurum	201
Branchiura	205
Bratislavia	45,99
bretscheri, Nais	95
brevidentatus, Rhyacodrilus	133,199
breviseta, Pristina	69
brinkhursti, Haplotaxis	33
brooksi, Rhynchelmis	213,225
californianus, Psammoryctides	129,155
carolinensis, Spirosperma	136,185
cervix, Limnodrilus	169
Chaetogaster	41,51
claparedianus, Limnodrilus	169
coccineus, Rhyacodrilus	125,197
columbiensis, Isochaetides	139,153
comata, Vejdovskyella	87
communis, Nais	97
convolutus, Psammoryctides	129,155



Crustipellis	37
culveri, Trichodrilus	219, 231
curvisetosus, Isochaetides	139, 153
daneus, Eclipidrilus (Premnodrilus)	233
Dero (Dero)	45, 75
Dero (Allodero)	45, 75
Dero (Aulophorus)	45, 75
diaphanus, Chaetogaster	51
diastrophus, Chaetogaster	51
digitata, Dero (Dero)	75, 79
Eclipidrilus (Eclipidrilus)	215, 221, 233
Eclipidrilus (Leptodrilus)	215, 221, 235
Eclipidrilus (Premnodrilus)	215, 221, 233
elinguis, Nais	97
elrodi, Rhynchelmis	227, 229
Enchytraeidae	24
falciformis, Rhyacodrilus	141, 191
(fissidens, Tubifex sp. inq.)	149
flabelliger, Dero (Aulophorus)	75, 83
(flagellum, Opistocystidae sp. inq.)	37
(flexipenis, Kopilrok sp. inq.)	147
floridana, Dero (Allodero)	75, 77
fontanus, Eclipidrilus (Leptodrilus)	235
(fragilis, Ilyodrilus sp. inq.)	171
frantzi, Ilyodrilus	121, 133, 143, 173
fraseri, Specaria	63
freidris, Kincaidiana	221, 223
freyi, Isochaetides	139, 153
frici, Paranais	57
frigidus, Eclipidrilus (Eclipidrilus)	235
fulleri, Varichaetadrilus	143, 177
furcata, Dero (Aulophorus)	75, 83
genitosetosus, Limnodrilus	241
(glandula, Rhynchelmis sp. inq.)	227, 229
gordiodes, Haplotaxis	33
grandis, Paranais	57
Haber	183
Haemonais	45, 73
hallae, Phalloadrilus	141, 207
(hamatus, Isochaetides sp. inq.)	139
(?hammonensis, potamothrix)	129, 159
Haplotaxidae	31
Haplotaxis	33
harmani, Tasserkidrilus	123, 147, 151
hellei, Specaria	63
heringianus, Stylodrilus	217, 243
hexatheca, Kincaidiana	213, 223
hoffmeisteri, Limnodrilus	167
Homochaeta	43
hylae, Dero (Allodero)	75, 77
idrensis, Pristinella	99, 107
ignotus, Tubifex	121, 147, 149
Ilyodrilus	171
(?inaequalis, Allonais)	85

(inconstans, Lumbriculis sp. inq.)	239
intermedia, Vejdovskyella	87
intermedius, Dero (Aulophorus)	
(=D. (A.) lodeni, pectinatus)	75,83
Isochaetides	139,153
josinae, Specaria	63
kessleri, Tasserkidrilus (=T. americanus)	123,147,151
Kincaidiana	223
(Kopilrok gen. inq.)	147
lacteus, Rhizodrilus	137,203
lacustris, Eclipsoidrilus (Leptodrilus)	235
lacustris, Stylaria	71
leidyi, Pristina	67
leydigi, Amphichaeta	55
limnaei, Chaetogaster	51
Limnodrilus	161,163
limnobioides, Aulodrilus	145,191
litoralis, Paranais	57
lodei, Dero (Aulophorus)	
(=D. (A.) intermedius, pectinatus)	75,83
lomondi, Arcteonais	71
longidentata, Pristinella	99,107
longisoma, Pristinella	99,103
Lophochaeta	149
Lumbriculidae	209
Lumbriculus	217,237
magnaseta, Nais	89
mastix, Teneridrilus	133,175
maumeensis, Limnodrilus	169
Metataxis	33
michiganensis, Piguetiella	47,61
minuta, Pristinella	99,105
minutus, Varichaetadrilus	127,179
moldaviensis, Potamothrix	139,157
montana, Rhyacodrilus	127,197
multiporus, Spelaedrilus	219,245
multisetosus, Quistadrilus	119,189
Naididae	39
naidina, Homochaeta	53
Nais	49,89
nerthus, Tubifex (?=T. newfei)	121,147,149
nevadana, Carichaetadrilus	121,177
newfei, Tubifex (?=T. nerthus)	121,147,149
nikolskyi, Spirosperma	
(=S. variegatus, S. oregonensis)	135,185
nivea, Dero (Dero)	75,79
(?notopora, Pristinella)	99,105
obtusa, Dero (Dero)	75,79
onegensis, Telmatodrilus	135,195
Ophidonais	43
Opistocysta	37
opisthothecus, Styloscolex	221,247
Opistocystidae	35

oregonensis, Spirosperma	
(=S. nikolskyi, S. variegatus)	135,185
osborni, Pristinella	99,105
pacificus, Varichaetadrilus	127,177
palustris, Eclipidrilus (Premnodrilus)	233
paraguayensis, Allonais	85
Paranais	43,57
parasita, Ripistes	71
pardalis, Nais	95
paucichaeta, Aulodrilus	145,193
(paucipilifer, Lophochaeta sp. inq.)	149
pectinata, Allonais	85
pectinata, Dero (Dero)	75,81
pectinatus, Dero (Aulophorus)	
(=D. (A.) lodeni, intermedius)	75,83
perrieri, Ilyodrilus	121,171
Phallodrilus	207
Piguetiella	43,47,61
pigueti, Aulodrilus	131,191
plumaseta, Pristina	69
pluriseta, Aulodrilus	121,191
Potamothrix	139,157
Pristina	43,67
Pristinella	45,99
(?proboscidea, Pristina)	67
profundicola, Limnodrilus	165
psammophilus, Varichaetadrilus	143,179
Psammoryctides	113,155
pseudobtusa, Nais	91
(punctatus, Rhyacodrilus sp. inq.)	199
Quistadrilus	119,189
raptisae, Amphichaeta	55
Rhizodrilus	203
Rhyacodrilus	197
Rhynchelmis	215,225
Ripistes	43,71
rostrata, Rhynchelmis (=R. alpestris)	227,229
rubripenis, Limnodrilus	161,163
(sagavanirktoki, Kopilrok sp. inq.)	147
serpentina, Ophidonais	59
setosus, Chaetogaster	51
silvani, Limnodrilus	165
sima, Pristinella	99,105
simplex, Nais	93
Slavina	47,87
sodalis, Rhyacodrilus	125,197
sovaliki, Stylodrilus	221,243
sowerbyi, Branchiura	131,205
Specaria	49,63
speciosus, Haber	115,183
Spelaedrilus	245
Spirosperma	185
Stephensoniana	45,99

Stylaria	43,71
Stylodrilus	217,243
Styloscolex	247
superiorensis, Tasserkidrilus	123,145,151
synclites, Pristina	69
tandyi, Stephensoniana	99
Tasserkidrilus	123,147
Telmatodrilus	195
templetoni, Ilyodrilus	123,171
Teneridrilus	133,175
tortilipenis, Limnodrilus	169
tribranchiata, Crustipellis	37
Trichodrilus	231
trifida, Dero (Dero)	75,81
trivandrana, Stephensoniana	99
Tubifex	121,147
tubifex, Tubifex	121,147,149
Tubificidae	109
udekemianus, Limnodrilus	161,163
Uncinaiis	43
uncinata, Uncinaiis	59
unidentata, Bratislavia	99,101
vaga, Dero (Aulophorus)	75,83
variabilis, Nais	97
Varichaetadrilus	177
variegatus, Lumbriculus	237
variegatus, Spirosperma (=S. niloksyi, S. oregonensis)	185
Vejdovskyella	47,87
vejdovskyanum, Bothrioneurum	141,201
vejdovskyi, Potamothrix	131,157
vejdovskyi, Telmatodrilus	145,195
waldvogeli, Haemonais	73
wulikensis, Arctodrilus	113,181



Canadä